

200
240
250



E-Chain System® E2 Medium Series 200/240/250



Price Index



Series 200/240/250

Special Features / Options



Flammability Class
VDE 0304 IIC UL94 HB

Assembly Tips

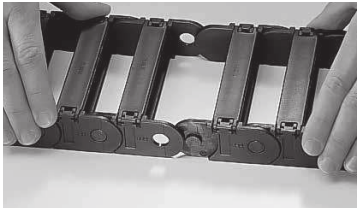

Easy to assemble and disassemble

Other Installation Methods

Vertical, hanging ≤ 131 ft (40 m)

Vertical, standing ≤ 9.84 ft (3 m)

Side-mounted, un_supp. ≤ 3.28 ft (1 m)

Rotary requires further calculation

Usage Guidelines



- If snap-open accessibility along the inner or outer radius is required (Series 200 does not open)
- If intergrated strain relief at the mounting point is required
- If modular interior separation is required
- If long service life is required
- If easy installation is required



- If each link requires snap-open accessibility on both sides simultaneously
 - Series 220 E4/100
- If chip protection is required
 - Series R48 E2 Tubes
- If the application is very simple
 - Series E200 E-Z Chain

Features & Benefits

- 1 Dirt-repellent contoured exterior
- 2 Cable-friendly, smooth interior with modular interior separation
- 3 Lateral glide surfaces for side mounted operation
- 4 Large pins for long service life
- 5 Double stop dog for long unsupported length
- 6 Tapered insertion point for easy assembly
- 7 Intergrated strain relief possible
- 8 Snap-open, hinged to left or right, accessible from the top
- 9 Series 240 snap-open along the inner radius can be combined with Series 250 snap-open along the outer radius



Order Example: Complete E-Chain®

Please indicate chain length or number of links. Example:

6.56 ft (2 m) 250-10-100-0

E-Chain®

With 2 separators 211 assembled every 2nd link

Interior Separation

1 Set 2100-34PZB

Mounting Bracket

E-Chain System® E2 Medium Series 200/240/250 Installation Dimensions

Short travel, unsupported length

- FL_B = unsupported with permitted sag
 - FL_G = unsupported with straight upper run
- Further information ► Design, Chapter 1

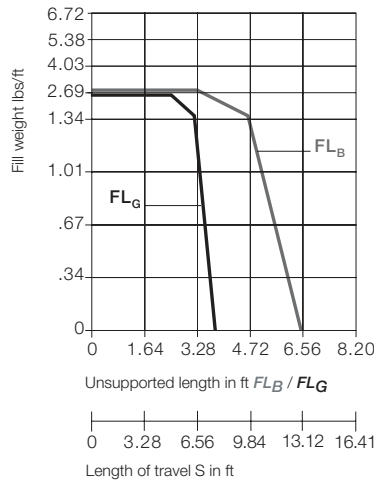
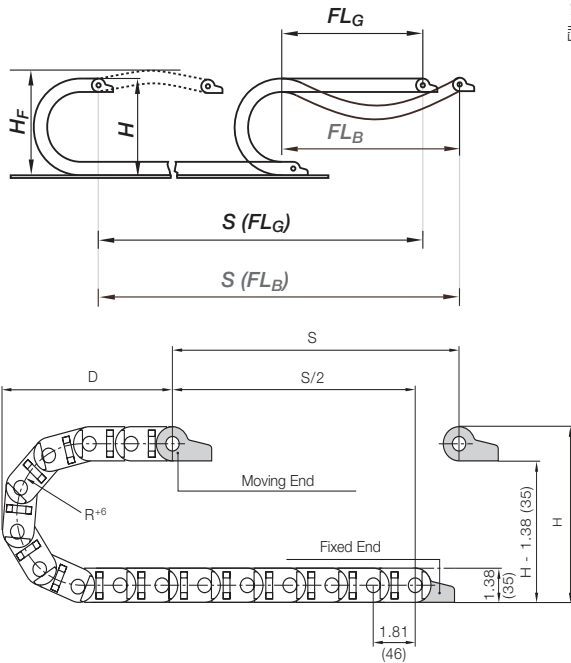

Pitch per link = 1.81" (46 mm)
Links per ft (m) = 6.63 (22)
For center mount applications:
Chain length = $\frac{S}{2} + K$

The required clearance height: $H_F = H + .98$ in. (25 mm) (with 1.01 lbs/ft (1.5 kg/m) fill weight).
Please consult igus® if space is particularly restricted.

	2.17 (55)	2.95 (75)	3.94 (100)	4.92 (125)	5.91 (150)	6.89 (175)	7.87 (200)	8.66 (225)	9.84 (250)
R	5.71 (145)	7.28 (185)	9.25 (235)	11.22 (285)	13.19 (335)	15.16 (385)	17.13 (435)	19.09 (485)	21.06 (535)
H ⁺⁴	4.92 (125)	5.91 (150)	6.69 (170)	7.68 (195)	8.66 (220)	9.65 (245)	10.63 (270)	11.61 (295)	12.60 (320)
D	10.87 (276)	13.62 (346)	16.30 (414)	19.53 (496)	22.76 (578)	25.98 (660)	29.21 (742)	32.05 (814)	36.22 (920)

For long travels with lowered mounting height

Long travel lengths from 32.8 ft. (10 m) to max. 328 ft. (100 m)

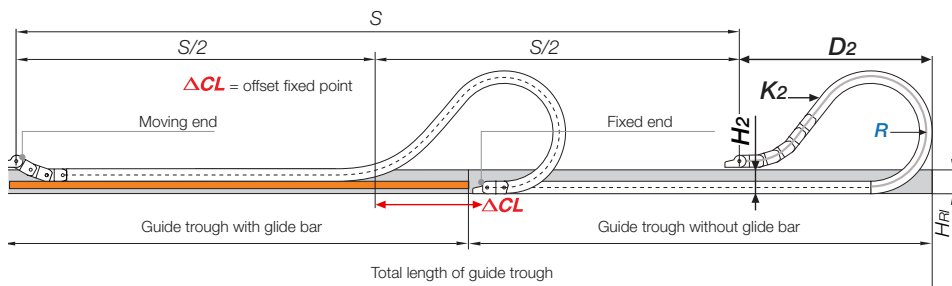

For center mount applications:
Chain length = $\frac{S}{2} + K_2$

Long Travels - Gliding



If the unsupported length is exceeded, the E-Chain®/ Tube must glide on itself. This requires a guide trough.

Design, Chapter 1

In case of travels between 13 ft. (4m) and 32.8 ft. (10m) we recommend a longer unsupported length.

	2.17 (55)	2.95 (75)	3.94 (100)	4.92 (125)	5.91 (150)	6.89 (175)	7.87 (200)	8.66 (225)	9.84 (250)
R	5.71 (145)	7.28 (185)	9.25 (235)	11.22 (285)	13.19 (335)	15.16 (385)	17.13 (435)	19.09 (485)	21.06 (535)
H ₂ ⁺⁴	—	—	3.94 (100)	3.94 (100)	3.94 (100)	3.94 (100)	3.94 (100)	3.94 (100)	3.94 (100)
D ₂ ⁺²⁵	—	—	14.96 (380)	17.32 (440)	23.23 (590)	29.72 (755)	37.40 (950)	40.94 (1040)	44.49 (1130)
K ₂	—	—	25.35 (644)	28.98 (736)	39.84 (1012)	48.90 (1242)	57.95 (1472)	63.39 (1610)	70.63 (1794)
ΔCL	—	—	8.03 (204)	9.61 (244)	14.33 (364)	19.84 (504)	26.54 (674)	29.69 (754)	31.65 (804)

Speed / acceleration FL_G	max. 65.6 ft/s (20 m/s) / max. 656 ft/s ² (200 m/s ²)
Speed / acceleration FL_B	max. 9.84 ft/s (3 m/s) / max. 19.69 ft/s ² (6 m/s ²)
Gliding speed / acceleration (maximum)	max. 32.81 ft/s (10 m/s) / max. 164 ft/s ² (50 m/s ²)
Material - permitted temperature	igumid G / -40°F (-40°C) up to +248°F (+120°C)
Flammability Class, igumid G	VDE 0304 IIC UL94 HB

Technical Data



Details of material properties

► Chapter 1

igus®

200
240
250

.98

Short Travels - Unsupported



Unsupported E-Chains® feature positive camber over short travels. This must be accounted for when specifying the clearance height. Please refer to Installation dimensions for further details.

Legend

- S = Length of travel
- R = Bending radius
- H = Nominal clearance height
- D = Overlength E-Chain® radius in final position
- $K = \pi \cdot R + \text{safety buffer}$
- H_F = Required clearance height
- H_{RI} = Trough inner height
- H₂ = *Mounting height
- D₂ = Overlength - long travels, gliding
- K₂ = *Add-on

*If the mounting bracket location is set lower

PDF: www.igus.com/e-chain-pdfs
Specs/CAD/RFQ: www.igus.com/e-chains
RoHS info: www.igus.com/RoHS



4.178

200
240
250



E-Chain System® E2 Medium Series 200/240/250

igus® E-Chain
System®

Telephone 1-800-521-2747
Fax 1-401-438-7270

Series 200 - Non snap-open

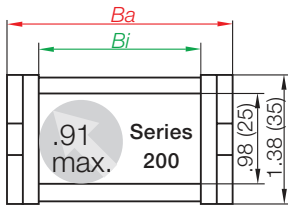

Part Number Structure



Color - Black
Bending radius
Width
Series

Series 240 - Snap-open along the inner radius

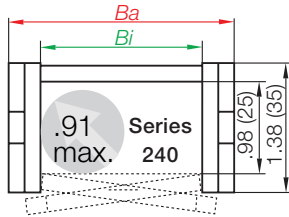

Part Number Structure



Color - Black
Bending radius
Width
Series

Series 250 - Snap open along the outer radius

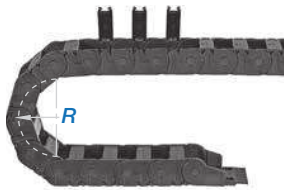
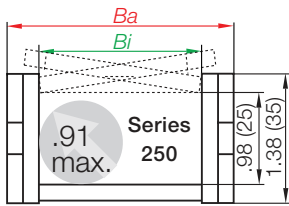

Part Number Structure



Color - Black
Bending radius
Width
Series

Supplement part number with required radius. Example: 250-10-100-0
Pitch: 1.81 in. (46 mm) per link links/ft (m) = 6.71 (22)

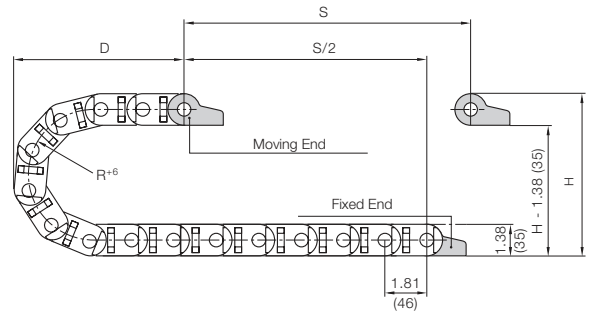

Non Snap-open	Part Number	Snap-open Inner Radius	Snap-open Outer Radius		Bi in. (mm)	Ba in. (mm)	Weight lbs/ft (kg/m)
	200-02	240-02	250-02	<input type="checkbox"/> -0	.98 (25)	1.61 (41)	≈ 0.50 (0.74)
	200-03-	240-03	250-03	<input type="checkbox"/> -0	1.50 (38)	2.13 (54)	≈ 0.54 (0.81)
	200-05-	240-05	250-05	<input type="checkbox"/> -0	2.24 (57)	2.87 (73)	≈ 0.60 (0.90)
	200-07-	240-07	250-07	<input type="checkbox"/> -0	3.03 (77)	3.66 (93)	≈ 0.68 (1.01)
	200-09-	240-09	250-09	<input type="checkbox"/> -0	3.54 (90)	4.17 (106)	≈ 0.73 (1.08)
	200-10	240-10	250-10	<input type="checkbox"/> -0	4.06 (103)	4.69 (119)	≈ 0.77 (1.15)
	200-12	240-12	250-12	<input type="checkbox"/> -0	4.92 (125)	5.55 (141)	≈ 0.82 (1.22)

Choose from the radii below for all of the above sizes
Radius (mm) Example: 250-10-100-0

R	55	075	100	125	150	175	200	225	250
R	2.17 (55)	2.95 (75)	3.94 (100)	4.92 (125)	5.91 (150)	6.89 (175)	7.87 (200)	8.86 (225)	9.84 (250)
H ₊₄	5.71 (145)	7.28 (185)	9.25 (235)	11.22 (285)	13.19 (335)	15.16 (385)	17.13 (435)	19.09 (485)	21.06 (535)
D	4.92 (125)	5.91 (150)	6.69 (170)	7.68 (195)	8.66 (220)	9.65 (245)	10.63 (270)	11.61 (295)	12.60 (320)
K	10.87 (276)	13.62 (346)	16.30 (414)	19.53 (496)	22.76 (578)	25.98 (660)	29.21 (742)	32.05 (814)	36.22 (920)

0=Standard color black. For other colors see Chapter 1

Internet: <http://www.igus.com>
email: sales@igus.com
QuickSpec: <http://www.igus.com/quickspec>

E-Chain System® E2 Medium Series 200/240/250 Interior Separation



200
240
250

Option 1: Vertical separators and spacers

Vertical separators are used if a vertical subdivision of the E-Chain® interior is required. By standard, vertical separators are assembled every other E-Chain® link. These separators are the only option when compartmentalizing the interior of the non snap-open E-Chain® such as the Series 200. Both are predominantly used for side-mounted applications.

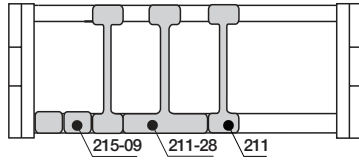

Standard

Vertical separator
201



Vertical Separator

Unassembled **Part No. 201**

Assembled **Part No. 211**

- **Standard separator 201 for E-Chains®**
This separator is used for general subdivision of E-Chain®.

Vertical separator
201-28

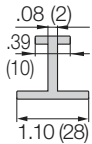

Vertical Separator

Unassembled **Part No. 201-28**

Assembled **Part No. 211-28**

- **Standard separator 201-28 for E-Chains®**
This separator features a wide base for use when a large distance between separators is required.

Spacers
205-09



Spacer

Unassembled **Part No. 205-09**

Assembled **Part No. 215-09**

- **NOTE ON SPACERS**
Vertical separators are adjustable, but can be fixed in position by means of a spacer. Spacers are most often necessary for side mounted applications. The available inner height is reduced by .08" (2mm) **per spacer** (for example if one spacer is placed on either side of the separator, the overall inner height is reduced by .16" (4mm)). To avoid this, place the spacers on the **outside** of the opening crossbar (**not for long travels**).

Option 2: Full-width shelf

This option is available for the snap-open Series 240/250 chains. It is ideal for use in applications involving many thin cables with similar or identical diameters. This shelf slides into place and spans the entire width of the chain.

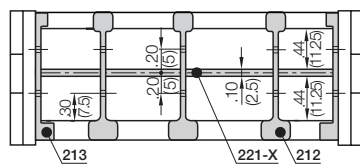

Slotted vertical separator
202

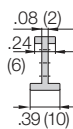

Vertical Separator

Unassembled **Part No. 202**

Assembled **Part No. 212**

- **Slotted separator 202 for E-Chains®**
This component is used to form the basic pattern of a shelf system.

Side Plate
203

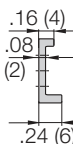

Side plate

Unassembled **Part No. 203**

Assembled **Part No. 213**

- **Side plate 203 for E-Chains®**
This component is used to form the basic pattern of a shelf system.

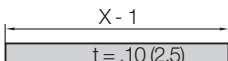

Width X in. (mm)	Part No. Unassembled	Part No. Assembled	Width X in. (mm)	Part No. Unassembled	Part No. Assembled
.98 (25)	220-25	221-25	3.54 (90)	220-90	221-90
1.50 (38)	220-38	221-38	4.06 (103)	220-103	221-103
2.24 (57)	220-57	221-57	4.92 (125)	220-125	221-125
3.03 (77)	220-77	221-77			

PDF: www.igus.com/e-chain-pdfs
Specs/CAD/RFQ: www.igus.com/e-chains
RoHS info: www.igus.com/RoHS



200
240
250



E-Chain System® E2 Medium Series 200/240/250 Interior Separation

Option 3: Shelves

This option is available for the Series 240/250 snap-open chains. It is ideal for use in applications involving many cables with different diameters. This option allows for variable compartment heights and widths across the chain width, but can also be used for level separation across the entire width.

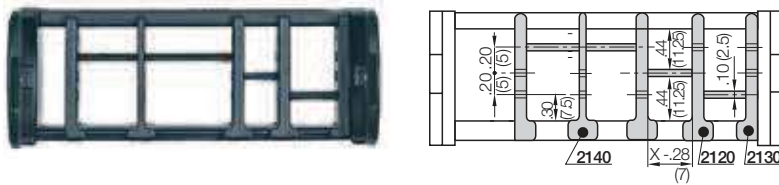

igus® E-Chain
System®

Telephone 1-800-521-2747
Fax 1-401-438-7270

Side plate
2030

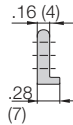

Vertical Separator
Unassembled **Part No. 2030**
Assembled **Part No. 2130**

- **Side plate 2030 for E-Chains®**
This component is used to form the basic pattern of a shelf system.

Vertical separator
2040

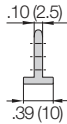

Vertical Separator
Unassembled **Part No. 2040**
Assembled **Part No. 2140**

- **Vertical slotted separator 2040 for E-Chains®**
This component is used to form the basic pattern of a shelf system.

Vertical separator
2020

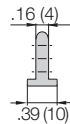

Vertical Separator
Unassembled **Part No. 2020**
Assembled **Part No. 2120**

- **Vertical slotted separator 2020 for E-Chains®**
This component is used to form the basic pattern of a shelf system.

Width X in. (mm)	Part No.	
	Unassembled	Assembled
.71 (18)	2200-18	2210-18
.91 (23)	2200-23	2210-23
1.10 (28)	2200-28	2210-28
1.30 (33)	2200-33	2210-33
1.50 (38)	2200-38	2210-38
1.69 (43)	2200-43	2210-43
1.89 (48)	2200-48	2210-48
2.28 (58)	2200-58	2210-58
2.68 (68)	2200-68	2210-68
2.87 (73)	2200-73	2210-73
3.46 (88)	2200-88	2210-88
3.90 (99)	2200-99	2210-99
4.88 (124)	2200-124	2210-124

Shelves 2200-XX

These components form the basic pattern of a shelf system. Shelves of various widths can be arranged at 3 different heights in .20" (5mm) increments

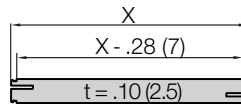

Internet: <http://www.igus.com>
email: sales@igus.com
QuickSpec: <http://www.igus.com/quickspec>

E-Chain System® E2 Medium Series 200/240/250 Mounting Brackets - Plastic



200
240
250



Option 1: pivoting

- Short and long travels
- Space-restricted conditions
- Corrosion resistant

Moving end
2...3PZB

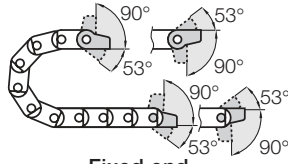

Fixed end
2...4PZB

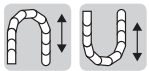

Option 2: locking

- Vertical hanging/standing travels
- Extreme accelerations
- Corrosion resistant

Moving end
2...1PZB

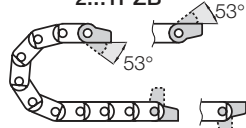

Fixed end
2...2PZB



Part Number Structure

2020- 34 PZ B K1

- With 10 cable tieswaps
- With tiewrap plates
- Without tiewrap plates
- Complete Set
34 = Pivoting
12 = Locking
- Mounting brackets for selected chain type

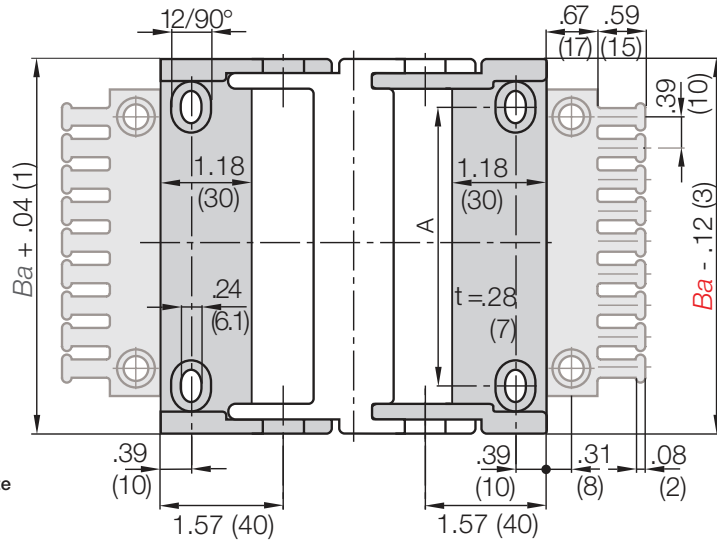

Full set, for both ends:

2020- 34 PZB Full set, each part with pin/bore + tiewrap plate

Single-part order:

2020- 3 PZB Mounting bracket with bore + tiewrap plate

2020- 4 PZB Mounting bracket with pin + tiewrap plate

Part No. Full Set (pivoting)

With Tiewrap Plates

Series 200, 240 or 250:

2020-34PZB

Part No. Full Set (pivoting)

With Tiewrap Plates

+ 10 cable ties

Series 200, 240 or 250:

2020-34PZBK1

Part No. Full Set (pivoting)

Without Tiewrap Plates

Series 200, 240 or 250:

2020-34PZ

For Chain Type	Part No. Full Set with Tiewrap Plate	Part No. Full Set with Tiewrap Plate + 10 cable ties	Part No. Full Set without Tiewrap Plate	Dimension A in. (mm)
200/240/250-02	2020- <input type="checkbox"/> PZB	2020- <input type="checkbox"/> PZBK1	2020- <input type="checkbox"/> PZ	.47 (12)
200/240/250-03	2030- <input type="checkbox"/> PZB	2030- <input type="checkbox"/> PZBK1	2030- <input type="checkbox"/> PZ	.98 (25)
200/240/250-05	2050- <input type="checkbox"/> PZB	2050- <input type="checkbox"/> PZBK1	2050- <input type="checkbox"/> PZ	1.73 (44)
200/240/250-07	2070- <input type="checkbox"/> PZB	2070- <input type="checkbox"/> PZBK1	2070- <input type="checkbox"/> PZ	2.52 (64)
200/240/250-09	2090- <input type="checkbox"/> PZB	2090- <input type="checkbox"/> PZBK1	2090- <input type="checkbox"/> PZ	3.03 (77)
200/240/250-10	2100- <input type="checkbox"/> PZB	2100- <input type="checkbox"/> PZBK1	2100- <input type="checkbox"/> PZ	3.54 (90)
200/240/250-12	2125- <input type="checkbox"/> PZB	2125- <input type="checkbox"/> PZBK1	2125- <input type="checkbox"/> PZ	4.41 (112)

For pivoting brackets choose 34

For locking brackets choose 12

Example: 2020- 34 PZB

34 or 12

PDF: www.igus.com/e-chain-pdfs
Specs/CAD/RFQ: www.igus.com/e-chains
RoHS info: www.igus.com/RoHS



200
240
250



E-Chain System® E2 Medium Series 200/240/250 Mounting Brackets - KMA

igus® E-Chain
System®

Telephone 1-800-521-2747
Fax 1-401-438-7270

Internet: <http://www.igus.com>
email: sales@igus.com
QuickSpec: <http://www.igus.com/quickspec>

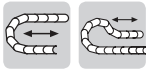

Standard

Option 1: pivoting

- Short travels
- Space-restricted conditions
- Corrosion resistant
- Bolted connection outside of chain cross section

Moving end
20000...1

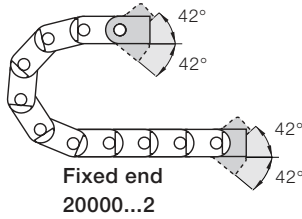

Stackable

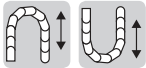

Option 2: locking

- Vertical hanging/standing travels
- Extreme accelerations
- Corrosion resistant
- Bolted connection outside of chain cross section

Moving end
21000...1

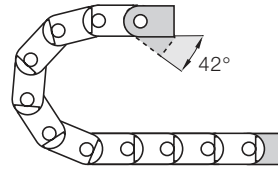

Stackable



Part Number Structure

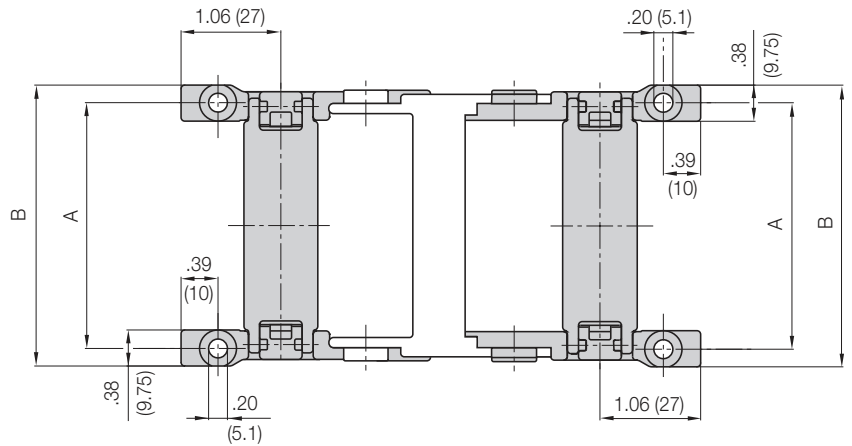
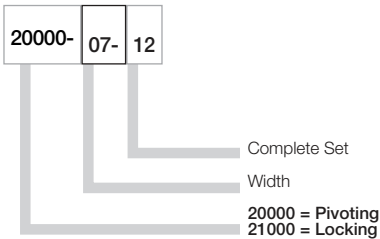

Full set, for both ends:

20000-07-12 Full set, each part with pin/bore

Single-part order:

20000-07-1 Mounting bracket with bore

20000-07-2 Mounting bracket with pin

Width	Part No. Full Set		Dimension A in. (mm)	Dimension B in. (mm)
	Pivoting	Locking		
-02	20000	21000	-02-12	1.36 (34.5) 1.73 (44)
-03	20000	21000	-03-12	1.87 (47.5) 2.24 (57)
-05	20000	21000	-05-12	2.62 (66.5) 2.99 (76)
-07	20000	21000	-07-12	3.41 (86.5) 3.78 (96)
-09	20000	21000	-09-12	3.92 (99.5) 4.29 (109)
-10	20000	21000	-10-12	4.43 (112.5) 4.80 (122)
-12	20000	21000	-12-12	5.30 (134.5) 5.67 (144)

E-Chain System® E2 Medium Series 200/240/250 Mounting Brackets - Steel



200
240
250



Option 1: Steel

- Pivoting connections
- One part (two-piece) for all chain widths
- Electrically conductive
- Bolted connection outside of chain cross-section possible

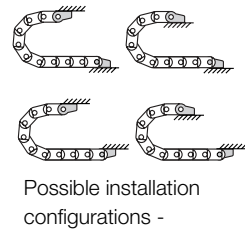
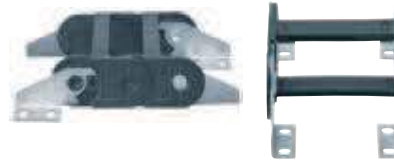
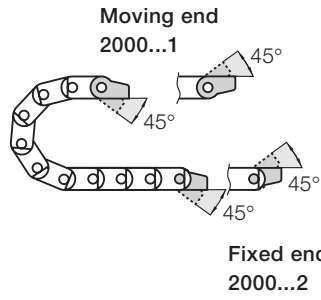

Possible installation configurations -

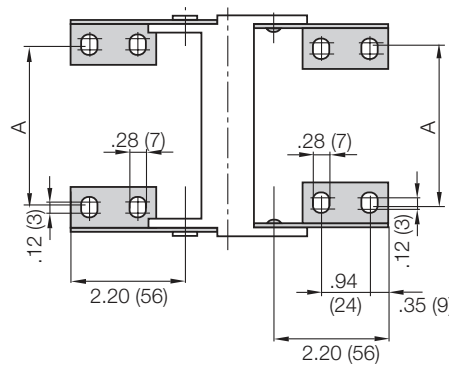
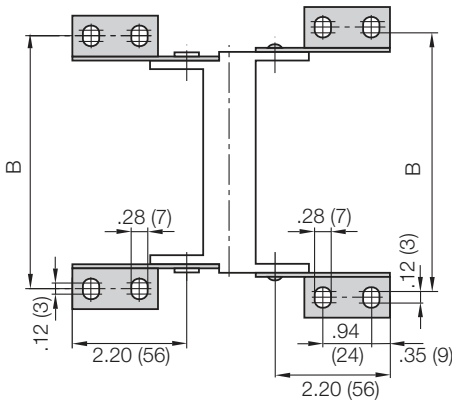

Chain Type	Part No. Full Set	Dimension A		Dimension B	
		in.	(mm)	in.	(mm)
200/240/250-02	2000-12	-		2.36	(60)
200/240/250-03	2000-12	.98	(25)	2.87	(73)
200/240/250-05	2000-12	1.73	(44)	3.62	(92)
200/240/250-07	2000-12	2.52	(64)	4.41	(112)
200/240/250-09	2000-12	3.03	(77)	4.92	(125)
200/240/250-10	2000-12	3.54	(90)	5.43	(138)
200/240/250-12	2000-12	4.41	(112)	6.30	(160)

Part No. Mounting Brackets Full Set

4 parts, 2 with pin, 2 with bore
Series 200/240/250:
2000-12

Part No. Mounting Bracket Moving End

2 parts, 1 left & 1 right
Series 200/240/250:
2000-1

Part No. Mounting Bracket Fixed End

2 parts, 1 left & 1 right
Series 200/240/250:
2000-2

PDF: www.igus.com/e-chain-pdfs
Specs/CAD/RFQ: www.igus.com/e-chains
RoHS info: www.igus.com/RoHS



200
240
250



E-Chain System® E2 Medium Series 200/240/250 Strain Relief

igus® E-Chain
System®

Telephone 1-800-521-2747
Fax 1-401-438-7270

Internet: <http://www.igus.com>
email: sales@igus.com
QuickSpec: <http://www.igus.com/quickspec>

Tiewrap Plates

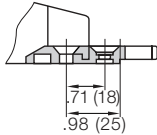

Shown assembled

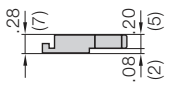

Single tiewrap plate



Option 1:

Tiewrap plates as an individual part

Available as an individual component, can be fixed onto a mounting bracket with the use of a profile rail.

Tiewrap Plates	n Number of Teeth	Dimension C	Dimension B
2020-ZB	3	1.18 (30)	.59 (15)
2030-ZB	4	1.57 (40)	.79 (20)
2040-ZB	5	1.97 (50)	1.18 (30)
2050-ZB	6	2.36 (60)	1.57 (40)
2070-ZB	8	3.15 (80)	2.36 (60)
2090-ZB	9	3.54 (90)	2.76 (70)
2100-ZB	10	3.94 (100)	3.15 (80)
2125-ZB	12	4.72 (120)	3.94 (100)

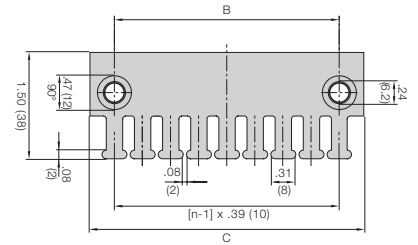

For more information please refer to strain relief section of Chapter 10

Strain relief for steel mounting brackets

Clip-on connection is not possible with steel mounting brackets. In this case, the tiewrap plates must be bolted directly into separate bore holes in front of the mounting bracket. Alternatively the tiewrap plates 20XX-ZB can be also used here. Details chapter 10

Cable tiewraps as individual parts

Cable tiewraps 100 pieces/bag	Width x Length		Maximum Ø		Tensile Strength	
	in.	(mm)	in.	(mm)	lbs	(N)
CFB-001	.19 x 5.91	(4.8 x 150)	1.42	(36)	50	(222)

E-Chain System® E2 Medium Series 200/240/250 Guide Trough



200
240
250

Guide troughs are used with applications where the upper run of the E-Chain® glides on the lower run. If using igus® steel guide troughs, the following components are required:

- Full travel length of guide trough
Part Number 92-30
- 1/2 travel length of glide bars
Part Number 92-01
- Installation sets as end connectors
Part Number 92-50-XX

-XX indicates the length of the profile rail on which the guide trough is mounted. The values and part numbers are specified in the table on the left. The standard length of the trough components and glide bars is 6.56 ft (2 m.) The required overall length of the guide trough directly correlates to the length of travel.

Example:
Length of travel 164 ft (50 m)
Center mounted

Required guide troughs:
164 ft (50 m) guide trough
82 ft (25 m) glide bar
= 25 sections of 6.56 ft
(2 m) guide trough
Part No. 92-30
= 13 sections of 6.56 ft (2 m) glide bar
Part No. 92-01

Required number of installation sets:
= Number of guide trough components + 1
= 25 + 1 = 26
Part number of the installation sets

Example: 92-50-400 for 15.75" (400 mm) long profile rail.



Width of Crossbar
250-05-200-0

	B_{Ri}	Installation Part No.
-02*	1.81 (46)	92-50-150
-03	2.32 (59)	92-50-175
-05	3.07 (78)	92-50-175
-07	3.86 (98)	92-50-200
-09	4.37 (111)	92-50-250
-10	4.88 (124)	92-50-250
-12	5.75 (146)	92-50-300

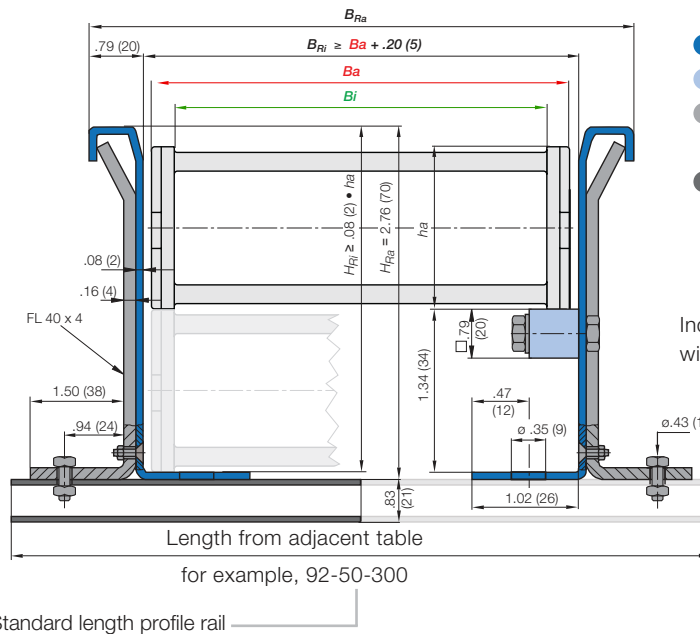

- Guide trough
- Glide bars
- Installation set "Basic"
- Profile rail

Individual attachment without profile rail

* Specialized guide trough available upon request

PDF: www.igus.com/e-chain-pdfs
Specs/CAD/RFQ: www.igus.com/e-chains
RoHS info: www.igus.com/RoHS

