

FD Series Filters

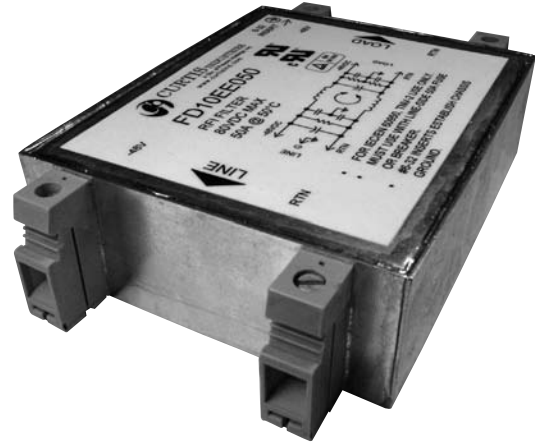

The FD Series of DC filters are designed as a general purpose line of filters for DC applications. They are designed to comply with UL/EN 60950 and UL 1459, CISPER 22 and Telecordia (Bellcore) GR-1089 at 25Amps and above. These filters are available with and without circuit breakers for additional protection.

The FD Series is a compact size that can filter up to 300MHz ideally suited for the telecom-datacom market. The FD0 Series is available from 6Amps to 100Amps in the smallest, economical package. The FD02 is a high frequency filter up to 3GHz (3,000MHz) in a compact package.

These filters are ideally used in communications and central office equipment.

- Power Supplies for Communications Equipment
- Network Routing Equipment
- Switching Equipment
- Base Stations
- Modems
- Services
- Ethernet Hubs



Specifications:

Rated Voltage: 80VDC Maximum

Rated Current: 6A
10A
20A
25A
50A
75A
100A

Current Overload: 6X for 8 seconds

Hi-Pot Rating (1 min):

Line to Ground 1060VDC
Line to Line 100VDC

Insulation Resistance: 1000 MΩ at 80VDC

Ambient Temperature: 0°C to 55°C (32°F to 131°F)

Humidity Range: 0% to 95% R.H.

Termination: See Chart at Right

Wire Leads: 18AWG 6A to 20A (FD0)
(FD0 25Amp to 100Amp not available with wire leads)

10AWG 30Amp (FD1, FD2, FD3)
6AWG 50Amp
4AWG 75Amp & 100Amp

Agency Approvals:

6Amp to 20Amp



E78454



064179



72031306



25Amp to 100Amp



E221098



72070096
72061592



E221098

General Purpose

DC FILTERS



Power Line Filter Selection Guide

FD00 & FD02 SERIES

FILTER Part Number	Current Rating (Amps)	Termination		
		Quick Connects	Wire Leads	Studs
FD00AA006	6	X		
FD00BB006	6		X	
FD00AA010	10	X		
FD00BB010	10		X	
FD00AA020	20	X		
FD00DD020	20			X
FD00DD025	25			X
FD00DD050	50			X
FD00DD075	75			X
FD00DD100	100			X
FD02DD025	25			X
FD02DD050	50			X
FD02DD075	75			X
FD02DD100	100			X

FD1, FD2, FD3 SERIES

FILTER Part Number	Current Rating (Amps)	Disconnect Type			Termination			
		Single Pole Rocker Breaker	Double Pole Rocker Breaker	Double Pole Handle Breaker	Wire Leads	High Current Connector	Euro Connector	Dual Stud T-Block
FD10BB030	30				X			
FD10EE030	30						X	
FD10BB050	50				X			
FD10EE050	50						X	
FD10BB075	75				X			
FD10BB100	100				X			
FD20B_ _ _	30, 50, or 80				X			
FD20E_ _ _							X	
FD20R_ _ _		X						X
FD20D_ _ _			X					X
FD20H_ _ _				X				X
FD20_B_ _ _						X		
FD20_C_ _ _							X	
FD20_E_ _ _								X
FD20_T_ _ _								X
FD30B_ _ _		30, 50, 75, or 100				X		
FD30E_ _ _							X	
FD30R_ _ _	X							X
FD30D_ _ _			X					X
FD30H_ _ _				X				X
FD30_B_ _ _						X		
FD30_C_ _ _							X	
FD30_E_ _ _								X
FD30_T_ _ _								X

General Purpose

DC FILTERS



FD Series Filters

How to Order

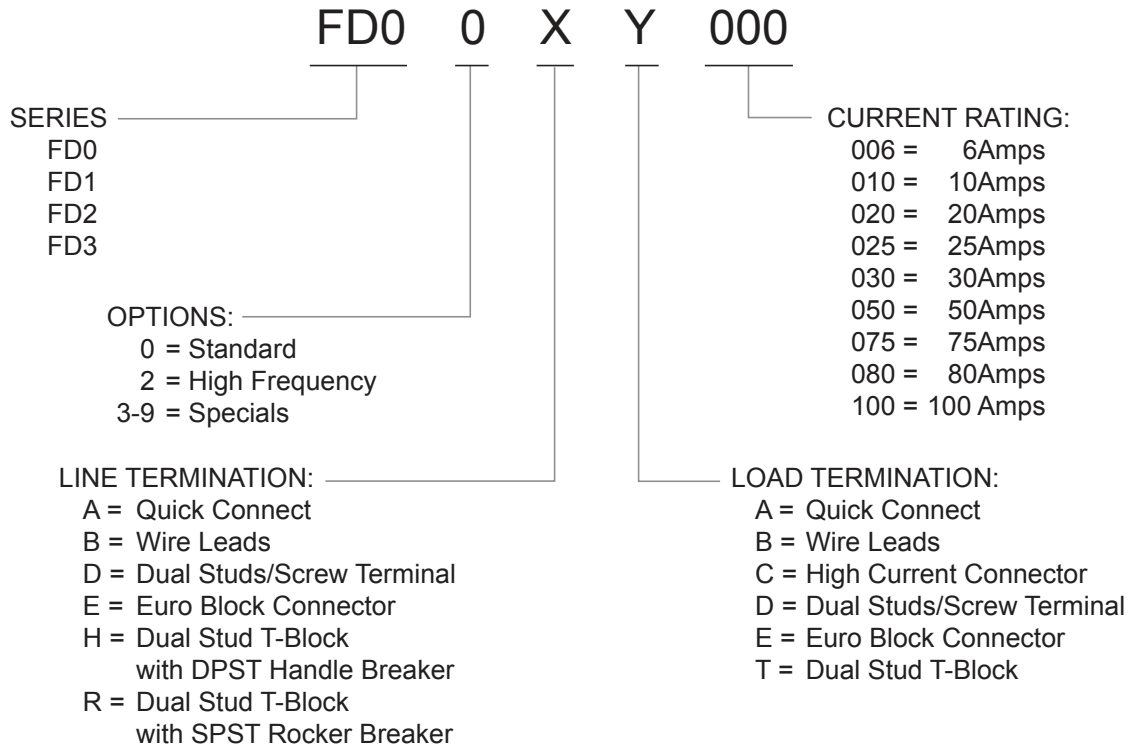

NOTE: Not all terminations are available in all models.

General Purpose

DC FILTERS

Part Number	TYPICAL INSERTION LOSS - dB (50 ohm Circuit)													
	MODE	Frequency - MHz												
		.01	.03	.10	.15	.50	1.0	5.0	10	30	100	300	1000	3000
FD00XX006 FD00XX010 FD00XX020	Common Differential	-	-	-	10 15	22 45	30 60	42 60	47 50	40 50	-	-	-	-
FD00XX025 FD00XX050 FD00XX075 FD00XX100	Common Differential	-	-	-	22 32	50 38	60 50	50 55	45 50	40 40	-	-	-	-
FD02XX025 FD02XX050 FD02XX100	Common Differential	5 40	5 45	35 45	45 45	60 48	60 50	55 45	55 55	50 48	40 45	10 15	20 58	25 40
FD10XX030 FD10XX050 FD10XX075 FD10XX100	Common Differential	5 55	15 60	48 70	60 70	65 70	65 65	60 70	60 60	55 50	25 35	25 15	-	-
FD20XX030 FD20XX050 FD20XX080	Common Differential	5 55	15 65	48 70	60 65	70 60	70 65	70 55	60 50	55 45	-	-	-	-
FD30XX030 FD30XX050 FD30XX075 FD30XX100	Common Differential	12 50	20 60	44 70	60 70	60 70	60 70	60 55	60 70	55 60	-	-	-	-



FD00 Filters

FD00AA (6, 10 and 20Amp) Dimensions

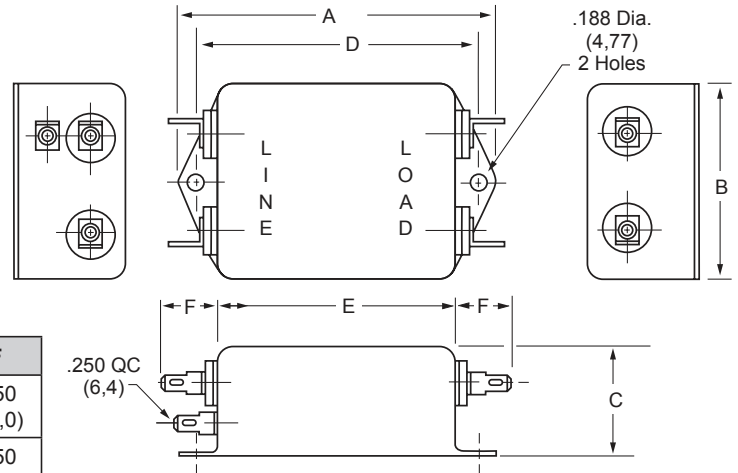
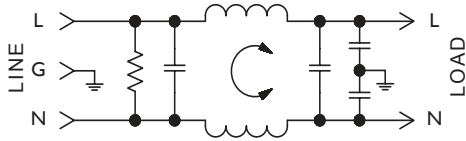

Amps	A	B	C	D	E	F
6A	3.312 (84,1)	2.000 (50,8)	1.125 (28,5)	2.940 (74,7)	2.500 (63,5)	.550 (14,0)
10A	3.312 (84,1)	2.000 (50,8)	1.500 (38,2)	2.940 (74,7)	2.500 (63,5)	.550 (14,0)
20A	See FD00DD below for Case Dimensions					

FD00BB

(6 and 10Amp) Dimensions

Amps	A	B	C	D	E
6A	3.312 (84,1)	2.000 (50,8)	1.125 (28,5)	2.940 (74,7)	2.500 (50,8)
10A	3.312 (84,1)	2.000 (50,8)	1.500 (38,1)	2.940 (74,70)	2.500 (50,8)

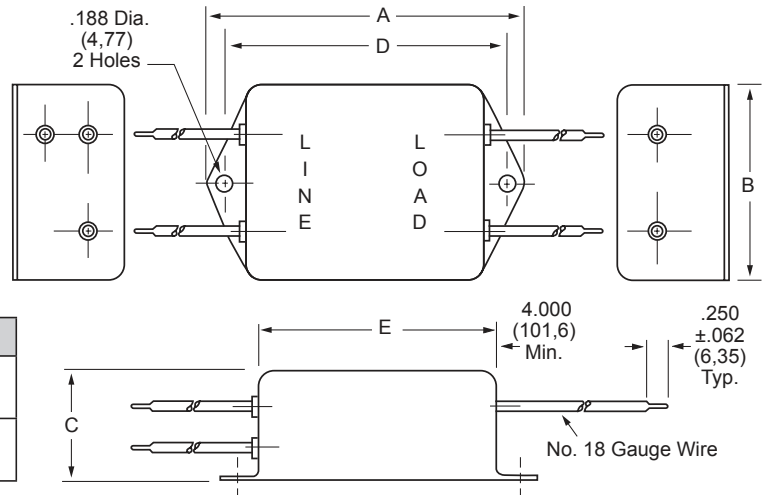

FD00DD (20Amp) Dimensions

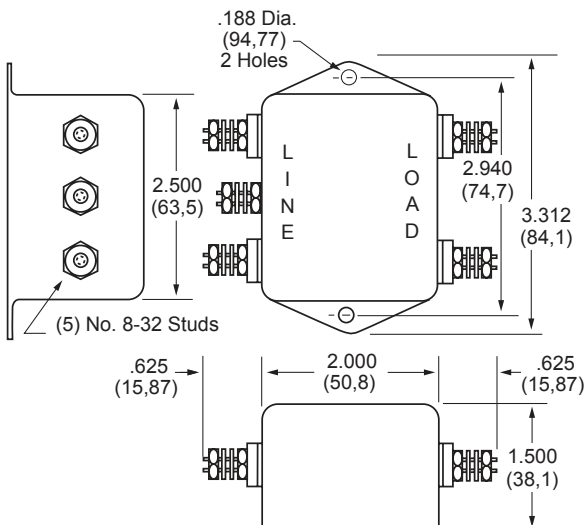

Dimensions are in inches and millimeters unless otherwise specified. Values in parentheses are metric equivalents.



Curtis Industries
A Division of Powers Holdings, Inc.

1-800-657-0853

67

General Purpose

DC FILTERS

FD00 & FD02 Filters

FD00DD (25, 50, 75 and 100Amp) Dimensions

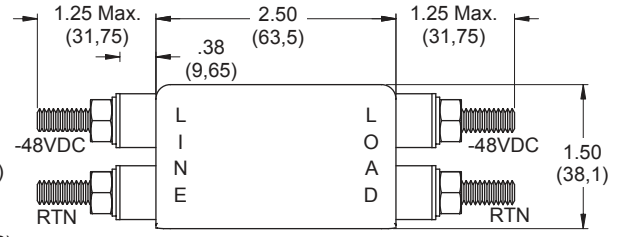
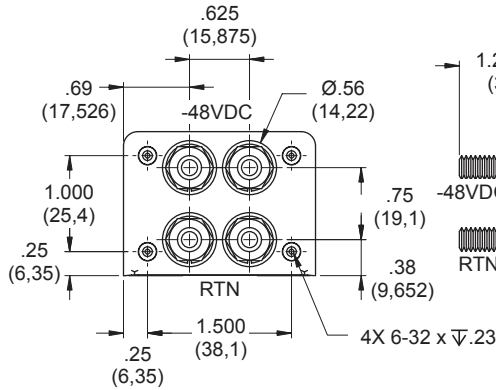
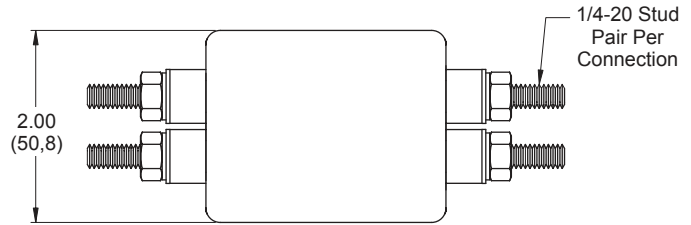
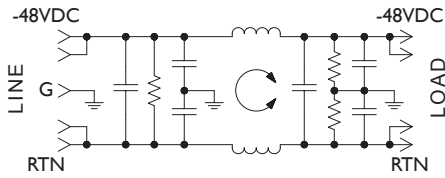

FD02DD (25, 50 and 100Amp) Dimensions

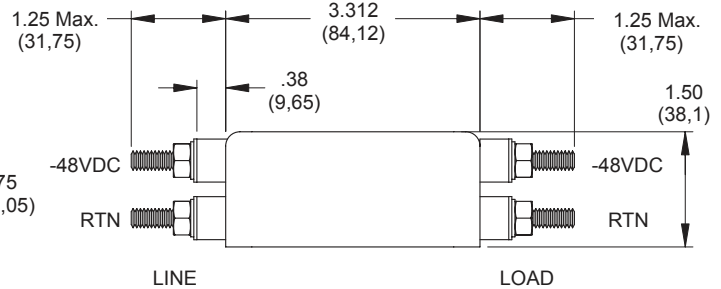
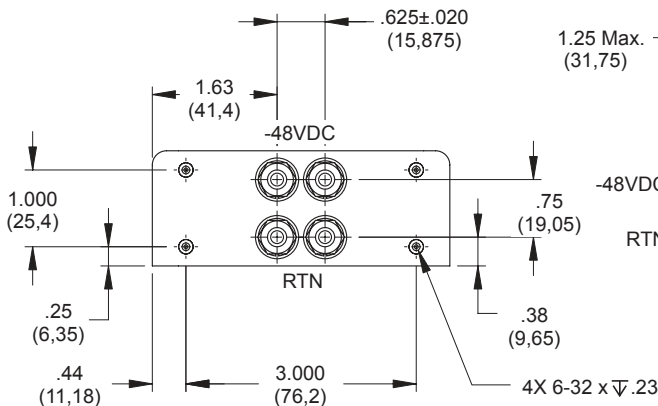
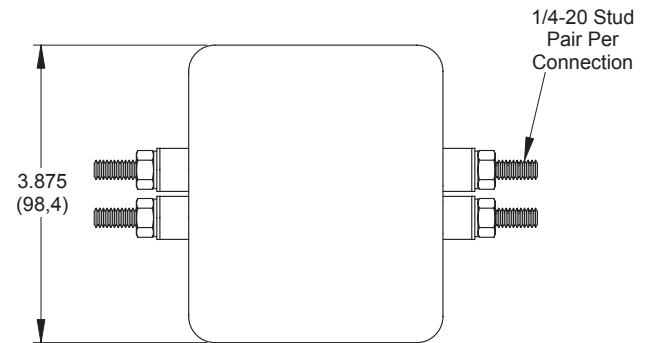
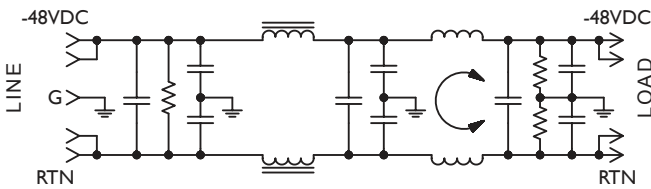

General Purpose

DC FILTERS



FD1 Filters

FD10EE050 (50Amp) Dimensions

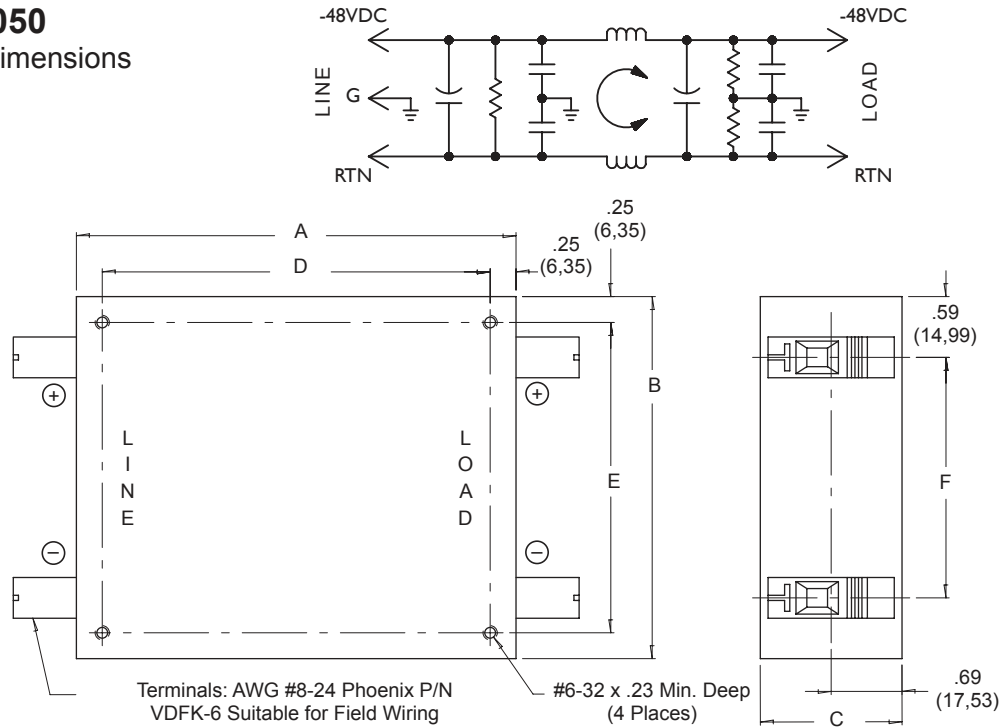

Amps	A	B	C	D	E	F
30A, 50A	4.25 (107,95)	3.50 (88,9)	1.37 (34,79)	3.750 (95,25)	3.000 (76,2)	2.33 (59,18)
75A, 100A	4.25 (107,95)	3.50 (88,9)	1.37 (34,79)	3.750 (95,25)	3.000 (76,2)	2.33 (59,18)

FD10BB100 (100Amp) Dimensions

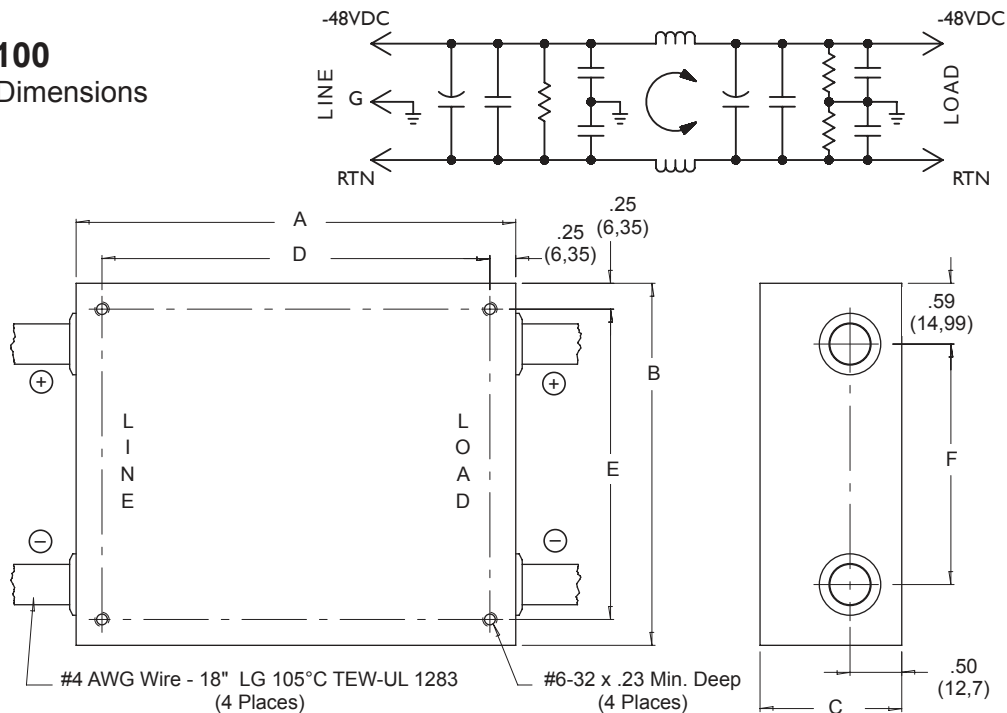

High Performance

DC FILTERS

Dimensions are in inches and millimeters unless otherwise specified. Values in parentheses are metric equivalents.



Curtis Industries
A Division of Powers Holdings, Inc.

1-800-657-0853

69

