

LISA2-M-CLIP

~20° medium beam optimized for CREE XP-E.
6.8 mm high variant with clip installation.

SPECIFICATION:

Dimensions	Ø 9.9 mm
Height	6.8 mm
Fastening	glue, clips
ROHS compliant	yes ⓘ



MATERIALS:

Component	Type	Material	Colour	Finish
LISA2-M	Single lens	PMMA	clear	
LISA2-HLD-CLIP16-XP	Holder	PC	black	





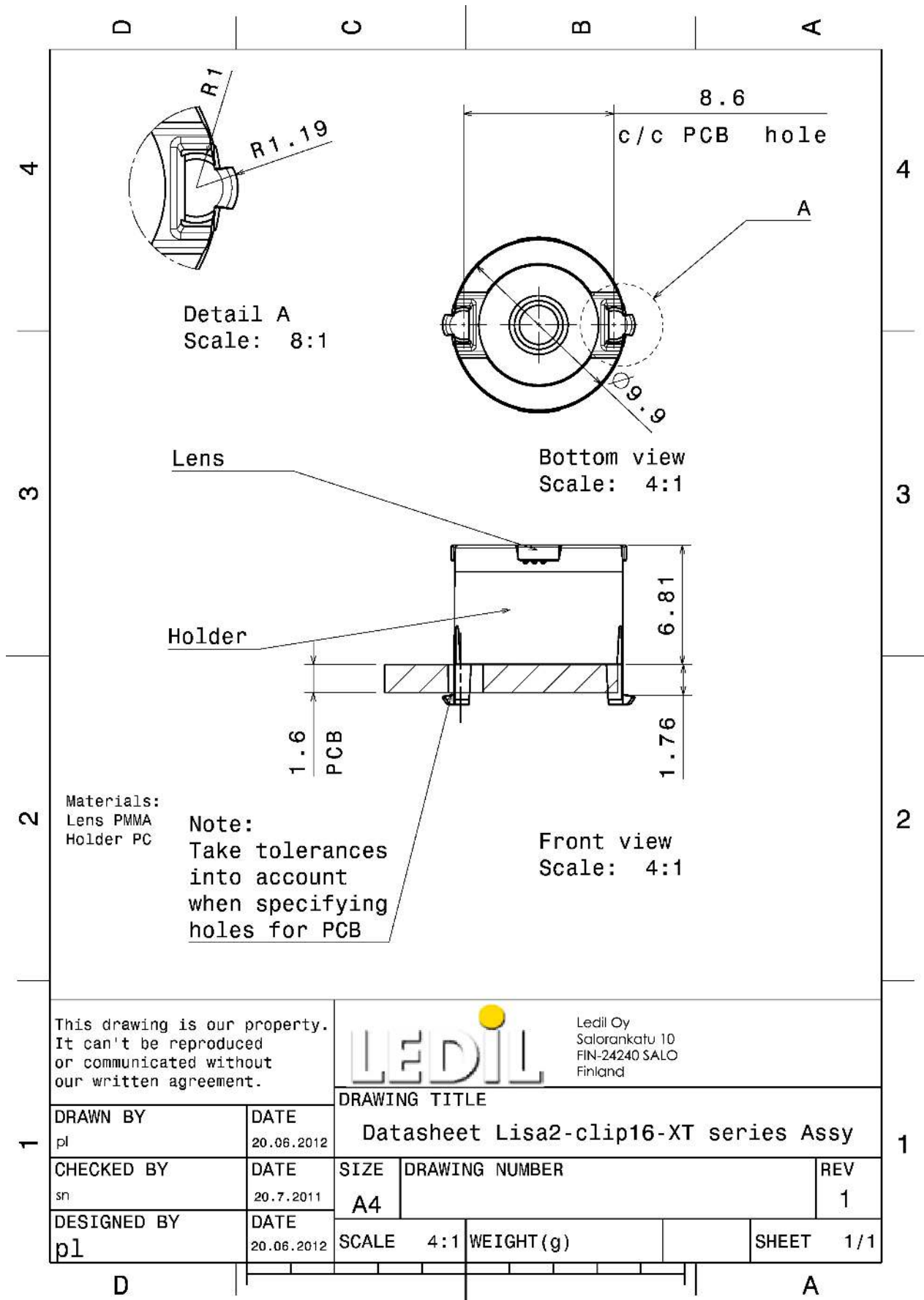



ORDERING INFORMATION:

Component	Type	Qty in box	MOQ	MPQ	Box weight (kg)
FP13030_LISA2-M-CLIP	Single lens	2000		100	1.4
» Box size:					

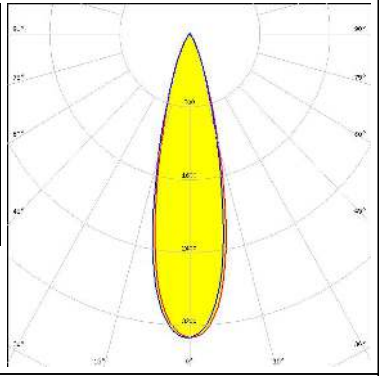

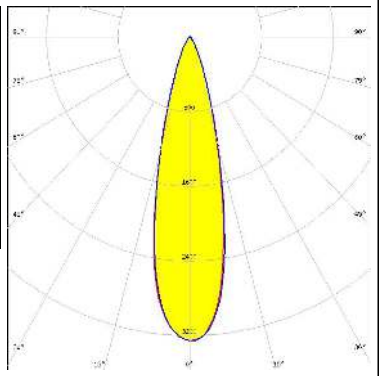

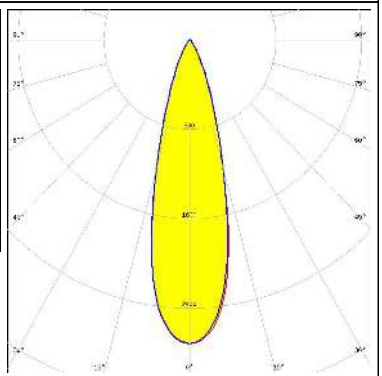
See also our general installation guide: www.ledil.com/installation_guide

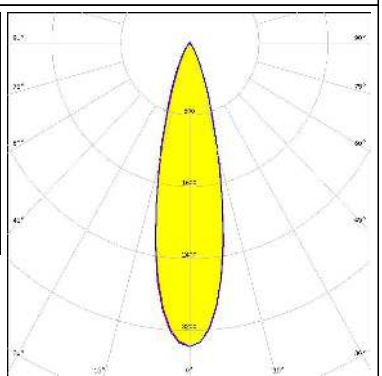

OPTICAL RESULTS (MEASURED):

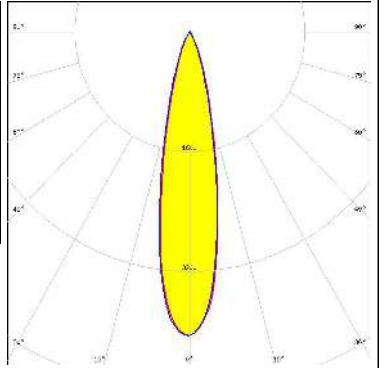
<p>CREE  LED</p> <p>LED: XP-G2 FWHM / FWTM: 25.0° / 47.0° Efficiency: 89 % Peak intensity: 3.5 cd/m LEDs/each optic: 1 Light colour: White Required components:</p>		
<p>CREE  LED</p> <p>LED: XT-E FWHM / FWTM: 26.0° / 49.0° Efficiency: 89 % Peak intensity: 3.3 cd/m LEDs/each optic: 1 Light colour: White Required components:</p>		
<p>LUMILEDS</p> <p>LED: LUXEON T FWHM / FWTM: 28.0° / 54.0° Efficiency: 87 % Peak intensity: 2.7 cd/m LEDs/each optic: 1 Light colour: White Required components:</p>		
<p>LUMILEDS</p> <p>LED: LUXEON TX FWHM / FWTM: 26.0° / 51.0° Efficiency: 88 % Peak intensity: 3.4 cd/m LEDs/each optic: 1 Light colour: White Required components:</p>		

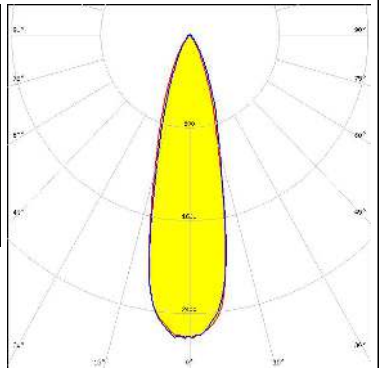
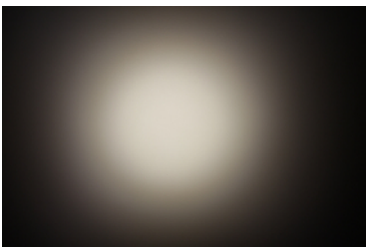
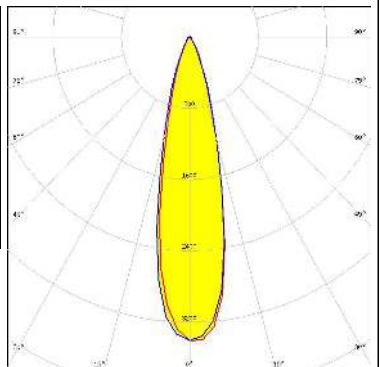
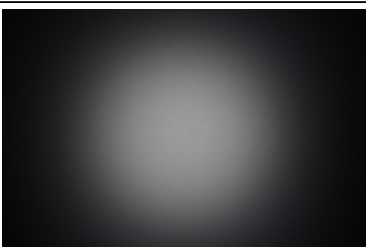
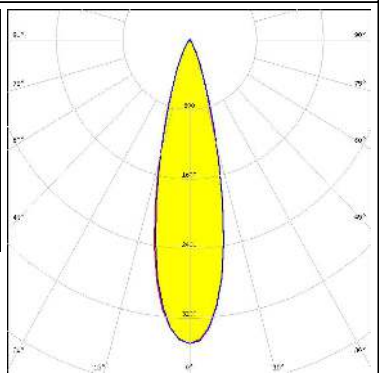
OPTICAL RESULTS (MEASURED):

<p>NICHIA</p> <p>LED NCSxx19B FWHM / FWTM 23.0° / 46.0° Efficiency 85 % Peak intensity 4.1 cd/m LEDs/each optic 1 Light colour White Required components:</p>		
<p>NICHIA</p> <p>LED NVSxx19B/NVSxx19C FWHM / FWTM 27.0° / 56.0° Efficiency 86 % Peak intensity 2.6 cd/m LEDs/each optic 1 Light colour White Required components:</p>		
<p>OSRAM <small>Opto Semiconductors</small></p> <p>LED OSLON Square EC FWHM / FWTM 26.0° / 49.0° Efficiency 85 % Peak intensity 3.4 cd/m LEDs/each optic 1 Light colour White Required components:</p>		
<p>SAMSUNG</p> <p>LED LH351Z FWHM / FWTM 26.0° / 50.0° Efficiency 87 % Peak intensity 3.5 cd/m LEDs/each optic 1 Light colour White Required components:</p>		

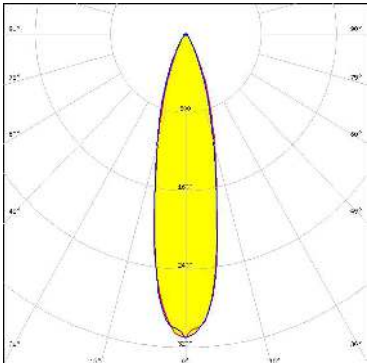
OPTICAL RESULTS (SIMULATED):

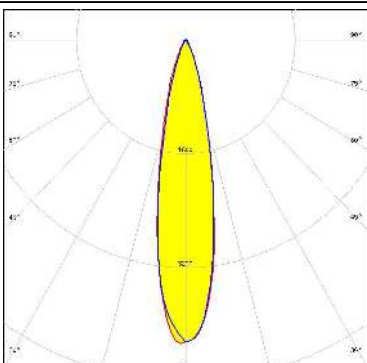
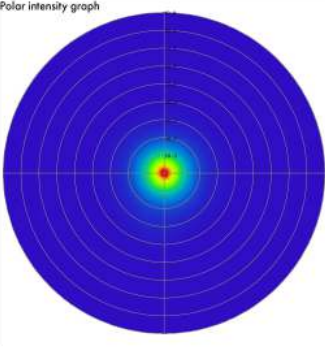
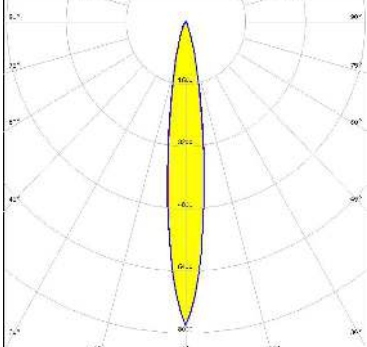
<p>LUMILEDS</p> <p>LED: LUXEON H50-2 FWHM / FWTM: 24.0° / 52.0° Efficiency: 89 % Peak intensity: 3.1 cd/lm LEDs/each optic: 1 Light colour: White Required components:</p>	
<p>LUMILEDS</p> <p>LED: LUXEON IR Compact FWHM / FWTM: 14.0° / 29.0° Efficiency: 82 % LEDs/each optic: 1 Light colour: White Required components:</p>	
<p>OSRAM <small>Opto Semiconductors</small></p> <p>LED: OSOLON Square CSSRM2/CSSRM3 FWHM / FWTM: 21.0° / 44.0° Efficiency: 91 % Peak intensity: 4.4 cd/lm LEDs/each optic: 1 Light colour: White Required components:</p>	
<p>OSRAM <small>Opto Semiconductors</small></p> <p>LED: SFH 4770S FWHM / FWTM: 14.0° / 33.0° Efficiency: 90 % LEDs/each optic: 1 Light colour: IR Required components:</p>	<div style="display: flex; justify-content: space-around;"> <div data-bbox="774 1608 1109 1966"> <p>Polar intensity graph</p>  </div> <div data-bbox="1129 1608 1497 1966">  </div> </div>

OPTICAL RESULTS (SIMULATED):

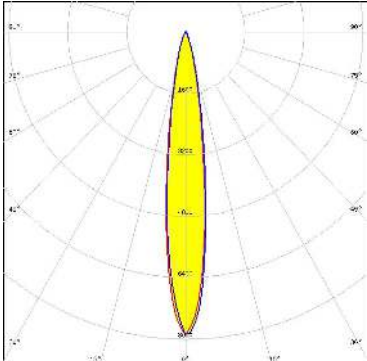
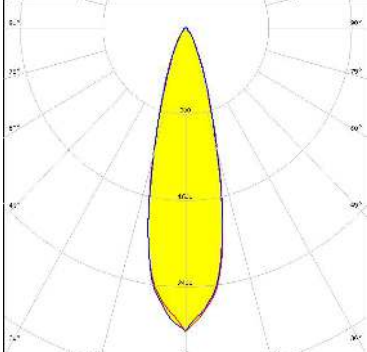
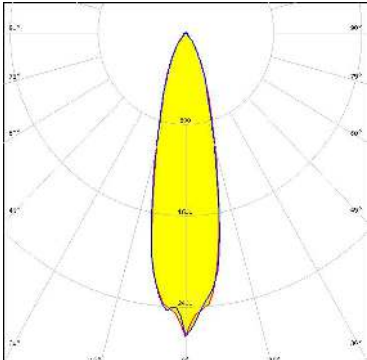
<p>OSRAM Opto Semiconductors</p> <p>LED Synios P2720 1/2 mm</p> <p>FWHM / FWTM 15.0° / 33.0°</p> <p>Efficiency 90 %</p> <p>Peak intensity 7.9 cd/lm</p> <p>LEDs/each optic 1</p> <p>Light colour White</p> <p>Required components:</p>	
<p>SAMSUNG</p> <p>LED LH351B</p> <p>FWHM / FWTM 27.0° / 54.0°</p> <p>Efficiency 89 %</p> <p>Peak intensity 2.8 cd/lm</p> <p>LEDs/each optic 1</p> <p>Light colour White</p> <p>Required components:</p>	
<p>SEMI SEOUL SEMICONDUCTOR</p> <p>LED Z8Y22P</p> <p>FWHM / FWTM 25.0° / 56.0°</p> <p>Efficiency 84 %</p> <p>Peak intensity 2.7 cd/lm</p> <p>LEDs/each optic 1</p> <p>Light colour White</p> <p>Required components:</p>	

GENERAL INFORMATION:

NOTE: The typical beam angle will be changed by different color, chip size and chip position tolerance. The typical total beam angle is the full angle measured where the luminous intensity is half of the peak value.

MATERIALS:

As part of our continuous research and improvement processes, and to ensure the best possible quality and availability of our products, LEDiL reserves the right to change material grades without notice.

PRODUCT DATA USER AGREEMENT AND DISCLAIMER:

The measured data in the provided downloadable LEDiL Product Datasheets and Mechanical 2D-Drawings is rounded and provided as reference for planning. LEDiL Oy's optical specifications have been verified by conducting performance testing of the products in accordance with the company's quality system. The reported data are averaged results of multiple measurements with typical variation. LEDiL Oy reserves the right to without prior notification make changes and improvements to its products.

LEDiL Oy assumes neither warranty, nor guarantee nor any other liability of any kind for the contents and correctness of the provided data. The provided data has been generated with highest diligence but the provided data may in reality not represent the complete possible variation range of all intrinsic parameters. Therefore, in certain cases a deviation from the provided data could occur.

LEDiL Oy reserves the right to undertake technical changes of its products without further notification which could lead to changes in the provided data. LEDiL Oy assumes no liability of any kind for the possible deviation from any provided data or any other damage resulting from the usage of the provided data.

The user agrees to this disclaimer and user agreement with the download or usage of the provided files.

LEDiL Oy

Joensuunkatu 13
FI-24240 SALO
Finland

LEDiL Inc.

228 West Page Street
Suite D
Sycamore IL 60178
USA

Ledil Optics Technology (Shenzhen) Co., Ltd.

405 , Block B
Casic Motor Building
Shenzhen 518057
P.R.CHINA

Local sales and technical support

[www.ledil.com/
where_to_buy](http://www.ledil.com/where_to_buy)

Shipping locations

Salo, Finland
Hong Kong, China

Distribution Partners

[www.ledil.com/
where_to_buy](http://www.ledil.com/where_to_buy)