



## MicroSynth® INTEGRATED SYNTHESIZER MODULE, 5.5 - 10.5 GHz



### Features

- Extremely Compact, Broadband Synthesizer
- 24-Bit Step Size, 1.2 Hz Resolution
- Auto and Triggered Sweeper Functions
- Integrated Low Noise Voltage Regulators
- Hermetic Module
- Operating Temperature: -40°C to +85°C
- Class 2 ESD Rating (2 kV)

### Typical Applications

The HMC-C070 is ideal for:

- Military Radar, EW & ECM
- Test & Measurement Equipment
- Lab Instrumentation
- Industrial/Medical Equipment

### General Description

The HMC-C070 MicroSynth® is a fully integrated broadband synthesizer module that combines high performance SiGe, GaAs pHEMT, and InGaP HBT technologies into one compact hermetic package. The output frequency range is 5.5 to 10.5 GHz with an average output power of +21 dBm, which is enough to drive two mixers. In fractional-N mode, the HMC-C070 can realize step sizes as low as 1.2 Hz. The HMC-C070 also features fully integrated low noise regulators and an output buffer amplifier which results in superior pushing and pulling performance. This module has been designed to withstand harsh environments and can be upscrambled to higher military standards upon request.

For theory of operation and register map refer to the MicroSynth® Operating Guide. To view the [Operating Guide](http://www.hittite.com), please visit [www.hittite.com](http://www.hittite.com) and choose HMC-C070 from the "Search by Part Number" pull down menu.

### Functional Diagram

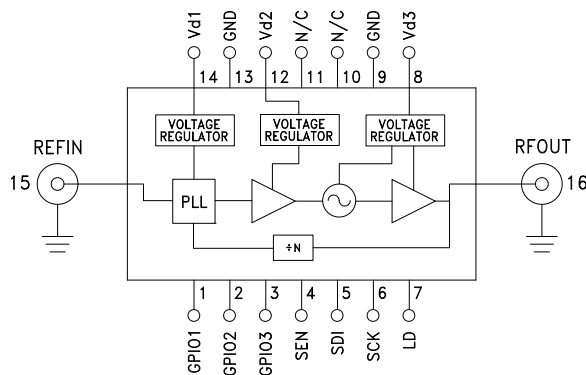

### Electrical Specifications, $T_A = +25^\circ\text{C}$ , $V_{d1} = 3.6\text{V}$ , $V_{d2} = 20\text{V}$ , $V_{d3} = 6\text{V}$

Parameter	Min.	Typ.	Max.	Units
Frequency Range	5.5 - 10.5			GHz
Power Output, 5.5 - 9.5 GHz	19	21		dBm
Power Output, 9.5 - 10.5 GHz	17.5	21		dBm
Phase Noise @ 100 Hz Offset		-78		dBc/Hz
Phase Noise @ 1 kHz Offset		-85		dBc/Hz
Phase Noise @ 10 kHz Offset		-87		dBc/Hz
Phase Noise @ 100 kHz Offset		-90		dBc/Hz
Phase Noise @ 1 MHz Offset		-117		dBc/Hz
Reference Spur (@ 10 MHz)	-45	-55		dBc
Second Harmonic		-20		dBc
Third Harmonic		-25		dBc
Prescaler Coefficient (M)		2		
Phase Settling Time (<3 degrees), 20 MHz Step		150		$\mu\text{S}$

Information furnished by Analog Devices is believed to be accurate and reliable. However, no responsibility is assumed by Analog Devices for its use, nor for any infringements of patents or other rights of third parties that may result from its use. Specifications subject to change without notice. No license is granted by implication or otherwise under any patent or patent rights of Analog Devices. Trademarks and registered trademarks are the property of their respective owners.

For price, delivery, and to place orders: Analog Devices, Inc., One Technology Way, P.O. Box 9106, Norwood, MA 02062-9106  
 Phone: 781-329-4700 • Order online at [www.analog.com](http://www.analog.com)  
 Application Support: Phone: 1-800-ANALOG-D



## MicroSynth® INTEGRATED SYNTHESIZER MODULE, 5.5 - 10.5 GHz

### Electrical Specifications, (Continued)

Parameter	Min.	Typ.	Max.	Units
Phase Settling Time (<3 degrees), 5 GHz Step		15		mS
Output Return Loss		13		dB
Loop Bandwidth		150		kHz
Reference (comparison) Frequency		10		MHz
Reference Input Power	-6	0	12	dBm
Voltage Supply (Vd1)	3.3	3.6	12	V
Supply Current (Id1)		100	125	mA
Voltage Supply (Vd2)	19	20	20.5	V
Supply Current (Id2)		20	25	mA
Voltage Supply (Vd3)	5.5	6	12	V
Supply Current (Id3)		300	375	mA
Total DC Power Dissipation		2.5	6.5	W

#### Output Power vs. Frequency

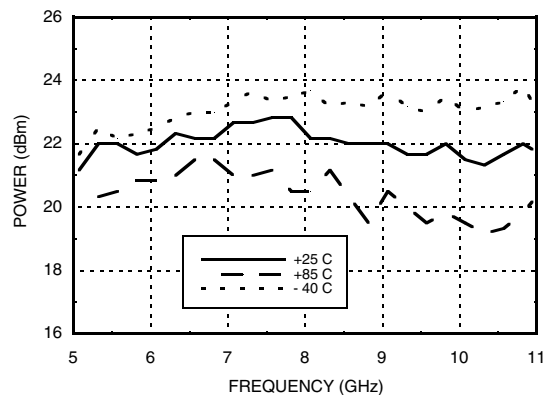

#### Phase Noise @ 5.5 GHz, Integer Mode

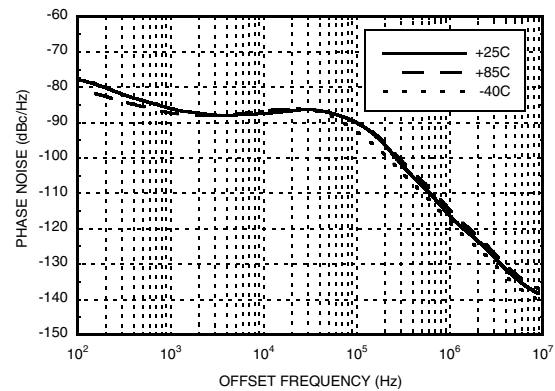

#### Phase Noise @ 7.5 GHz, Integer Mode

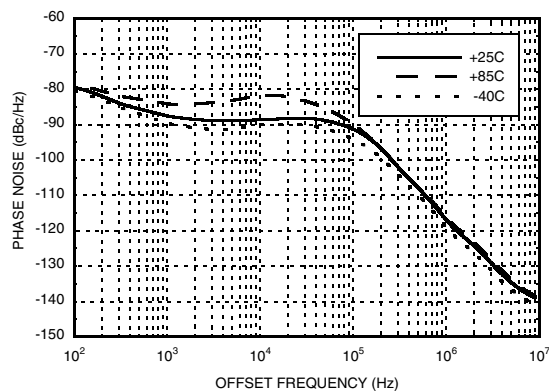

#### Phase Noise @ 10 GHz, Integer Mode

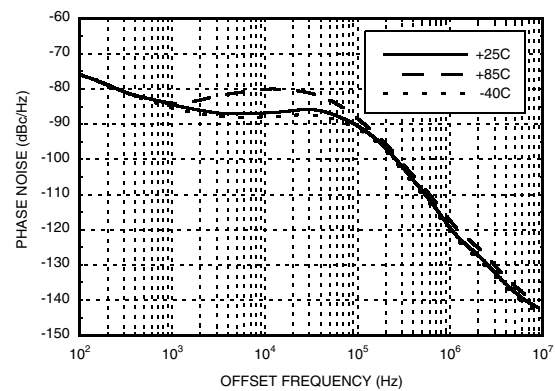

Information furnished by Analog Devices is believed to be accurate and reliable. However, no responsibility is assumed by Analog Devices for its use, nor for any infringements of patents or other rights of third parties that may result from its use. Specifications subject to change without notice. No license is granted by implication or otherwise under any patent or patent rights of Analog Devices. Trademarks and registered trademarks are the property of their respective owners.

For price, delivery, and to place orders: Analog Devices, Inc., One Technology Way, P.O. Box 9106, Norwood, MA 02062-9106 Phone: 781-329-4700 • Order online at [www.analog.com](http://www.analog.com) Application Support: Phone: 1-800-ANALOG-D



**MicroSynth® INTEGRATED  
SYNTHESIZER MODULE, 5.5 - 10.5 GHz**

Reference Spur

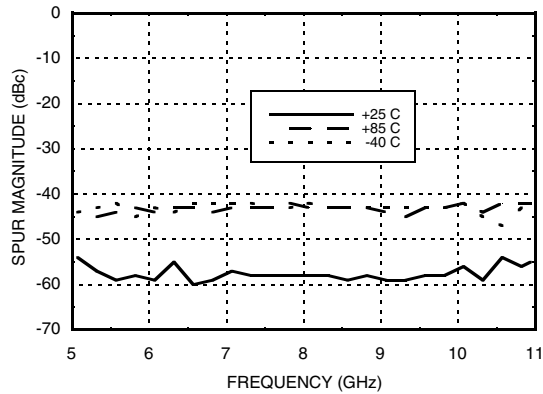

Second Harmonic vs. Frequency

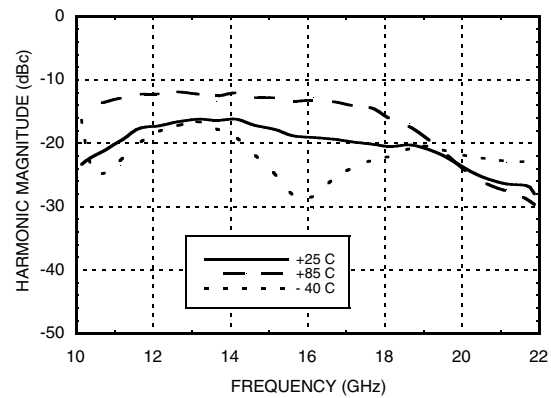

Third Harmonic vs. Frequency

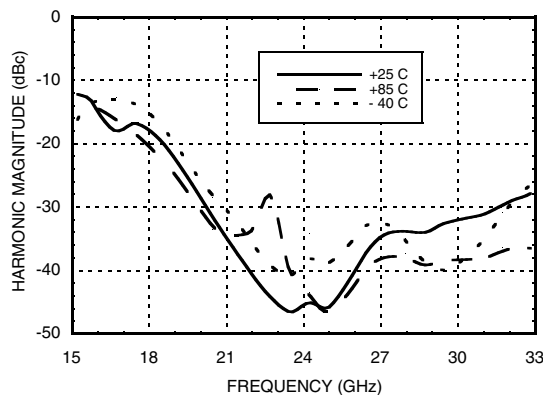

Absolute Maximum Ratings

Vd1	12 V
Vd2	20.5 V
Vd3	12 V
GPI01, GPI02, GPI03, SEN, SDI, SCK & LD	3.6 V
Continuous Pdiss (T = 85°C) (derate 68.9 mW/°C above 85°C)	6.5 W
Storage Temperature	-55 to +125 °C
Operating Temperature	-40 to +85 °C



**ELECTROSTATIC SENSITIVE DEVICE  
OBSERVE HANDLING PRECAUTIONS**

Information furnished by Analog Devices is believed to be accurate and reliable. However, no responsibility is assumed by Analog Devices for its use, nor for any infringements of patents or other rights of third parties that may result from its use. Specifications subject to change without notice. No license is granted by implication or otherwise under any patent or patent rights of Analog Devices. Trademarks and registered trademarks are the property of their respective owners.

For price, delivery, and to place orders: Analog Devices, Inc., One Technology Way, P.O. Box 9106, Norwood, MA 02062-9106 Phone: 781-329-4700 • Order online at [www.analog.com](http://www.analog.com) Application Support: Phone: 1-800-ANALOG-D

## MicroSynth® INTEGRATED SYNTHESIZER MODULE, 5.5 - 10.5 GHz



### Outline Drawing

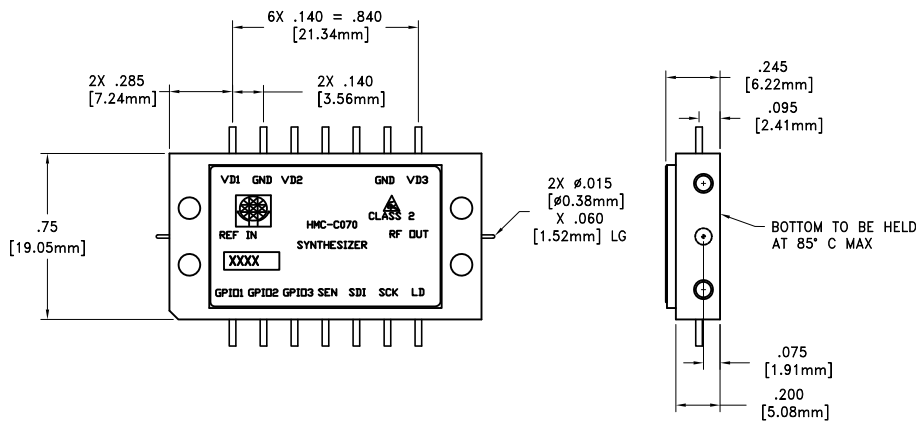
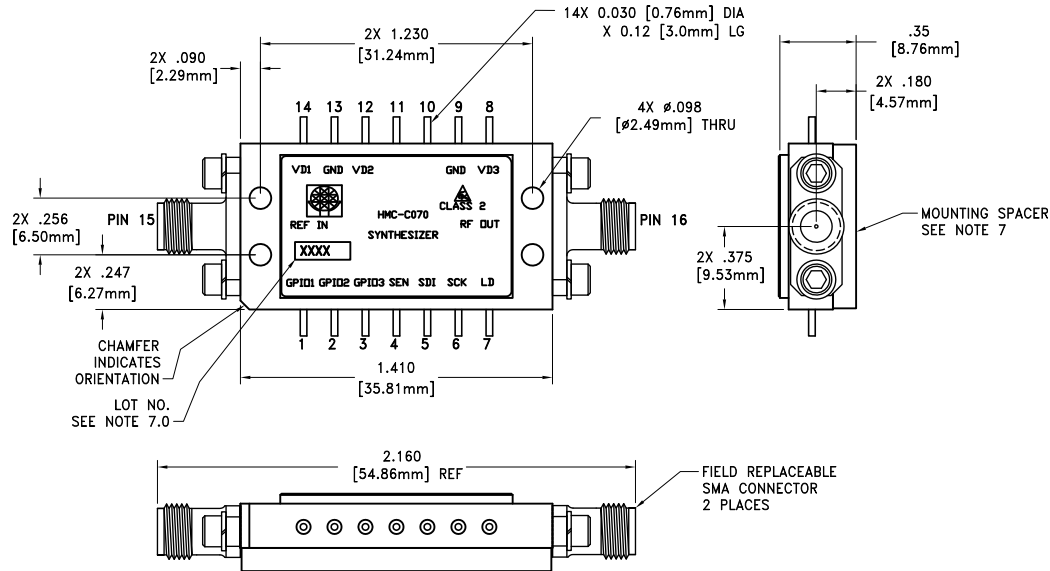

### Package Information

Package Type	C-20
Package Weight <sup>[1]</sup>	16.53g
Spacer Weight	4.6g



[1] Does not include connectors, or mounting hardware

### NOTES:

- 1.0 PACKAGE, LEADS, COVER MATERIAL: KOVAR™
- 2.0 FINISH: GOLD PLATE OVER NICKEL PLATE.
- 4.0 ALL DIMENSIONS ARE IN INCHES [MILLIMETERS].
- 5.0 TOLERANCES: UNLESS OTHERWISE SPECIFIED
- 5.1 .XX = ±0.02 [0.51]  
.XXX = ±0.010 [0.25]
- 6.0 MARK LOT NUMBER ON 0.080 X 0.250 LABEL WHERE SHOWN WITH 0.030" MIN TEXT HEIGHT.
- 7.0 MOUNTING SPACER PART NUMBER 123279.

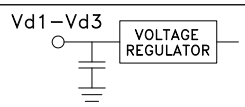

### Pin Descriptions

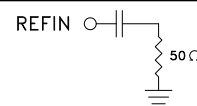
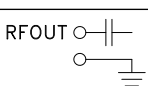
Pin Number	Function	Description	Interface Schematic
1 - 3	GPIO1, GPIO2, GPIO3	General Purpose I/O with Tristate, 3.3 V Logic	See operating guide. [1]
4	SEN	Serial port Enable Input, 3.3 V Logic	See operating guide. [1]
5	SDI	Serial port Data input, 3.3 V Logic	See operating guide. [1]
6	SCK	Serial port Clock input, 3.3 V Logic	See operating guide. [1]
7	LD	Lock Detect, 3.3 V Logic	See operating guide. [1]
8, 12, 14	Vd3, Vd2, Vd1	Voltage Supply Pins	
9, 13	GND	These pins must be connected to RF/DC ground.	
10, 11	N/C	Please leave these pins open as they are reserved for future product improvements.	
15	REFIN	Reference input, 10 MHz nominal, 220 MHz maximum. Note: the comparison frequency (reference freq./R) may not exceed 75 MHz and the module performance is not specified at comparison frequencies other than 10 MHz.	
16	RFOUT	Synthesizer RF output.	

[1] To view the [Operating Guide](#), please visit [www.hittite.com](http://www.hittite.com) and choose HMC-C070 from the "Search by Part Number" pull down menu.

MicroSynth<sup>®</sup> INTEGRATED  
SYNTHESIZER MODULE, 5.5 - 10.5 GHz

Notes: