

1445807-1 ✓ ACTIVE

AMP | AMP CPC

TE Internal #: 1445807-1

Circular Power Connectors, Housing, 250 VDC, 30 – 18 AWG Wire Size, .0509 – .823 mm² Wire Size, Wire-to-Wire, 9 Position, Sealable, AMP CPC

[View on TE.com >](#)



[Connectors](#) > [Power Connectors](#) > [Circular Power](#) > [Circular Power Connectors](#) > [Mini Circular Plastic Connectors \(CPC\)](#)



Connector Product Type: **Housing**

Operating Voltage: **250 VDC**

Wire Size: **.0509 – .823 mm²**

Connector System: **Wire-to-Wire**

[All Mini Circular Plastic Connectors \(CPC\) \(53\)](#)

Features

Product Type Features

Connector Seal & Plug Type	Wire Entry Seal
Connector Product Type	Housing
Connector System	Wire-to-Wire
Sealable	Yes
Connector & Contact Terminates To	Wire & Cable
Connector & Housing Type	Plug
Circular Connector Shell Type	All Plastic

Configuration Features

Reverse Numbering	Without
Number of Positions	9
Number of Power Positions	0
Number of Signal Positions	9

Electrical Characteristics



Operating Voltage	250 VAC
-------------------	---------

Contact Features

Reverse Gender	No
Contact Type	Socket
Contact Current Rating (Max)	5.9 A

Termination Features

Termination Method to Wire & Cable	Crimp
------------------------------------	-------

Mechanical Attachment

Mating Alignment	With
Mating Retention Type	Threaded Coupling
Thread Size	3/4-20 UNEF-2A
Mating Retention	With
Panel Mount Feature	Without

Housing Features

Housing Color	Black
Housing Material	Thermoplastic
Circular Connector Shell Size	11

Dimensions

Compatible Insulation Diameter Range	.89 – 1.5 mm [.035 – .059 in]
Wire Size	.0509 – .823 mm ²

Usage Conditions

Operating Temperature Range	-55 – 105 °C [-67 – 221 °F]
Fluid Resistance	Immersion

Operation/Application

Circuit Application	Power & Signal
Shielded	No

Industry Standards

UL Flammability Rating	UL 94V-0
------------------------	----------

Packaging Features

Packaging Quantity	100
Packaging Method	Bag



Product Compliance

[For compliance documentation, visit the product page on TE.com>](#)

EU RoHS Directive 2011/65/EU	Compliant
EU ELV Directive 2000/53/EC	Compliant
China RoHS 2 Directive MIIT Order No 32, 2016	No Restricted Materials Above Threshold
EU REACH Regulation (EC) No. 1907/2006	Current ECHA Candidate List: JUNE 2023 (235) Candidate List Declared Against: JAN 2022 (223) Does not contain REACH SVHC
Halogen Content	Not Low Halogen - contains Br or Cl > 900 ppm.
Solder Process Capability	Not reviewed for solder process capability

Product Compliance Disclaimer

This information is provided based on reasonable inquiry of our suppliers and represents our current actual knowledge based on the information they provided. This information is subject to change. The part numbers that TE has identified as EU RoHS compliant have a maximum concentration of 0.1% by weight in homogenous materials for lead, hexavalent chromium, mercury, PBB, PBDE, DBP, BBP, DEHP, DIBP, and 0.01% for cadmium, or qualify for an exemption to these limits as defined in the Annexes of Directive 2011/65/EU (RoHS2). Finished electrical and electronic equipment products will be CE marked as required by Directive 2011/65/EU. Components may not be CE marked. Additionally, the part numbers that TE has identified as EU ELV compliant have a maximum concentration of 0.1% by weight in homogenous materials for lead, hexavalent chromium, and mercury, and 0.01% for cadmium, or qualify for an exemption to these limits as defined in the Annexes of Directive 2000/53/EC (ELV). Regarding the REACH Regulation, the information TE provides on SVHC in articles for this part number is based on the latest European Chemicals Agency (ECHA) 'Guidance on requirements for substances in articles' posted at this URL: <https://echa.europa.eu/guidance-documents/guidance-on-reach>

Compatible Parts

<p>TE Part # CAT-AM71-C83998EE Mini Circular Plastic Connectors (CPC)</p>	<p>TE Part # 1445904-1 NUT, JAM, 3/4-20, PKG QTY 100</p>	<p>TE Part # 1-770988-1 MINI UMNL SOK 22-18AWG LP LF</p>	<p>TE Part # 1-770985-0 MINI UMNL PIN 26-22AWG AU LP</p>





TE Part # 1-770987-0
MINI UMNL PIN 22-18 AWG AU LP



TE Part # 770988-3
MINI UMNL SOK 22-18AWG AU LP



TE Part # 1-770988-0
MINI UMNL SOK 22-18AWG AU



TE Part # 1-794059-0
MINI UMNL PIN L/P LF



TE Part # 770988-1
MINI UMNL SOK 22-18AWG SN LP



TE Part # 770986-1
MINI UMNL SOK 26-22AWG SN LP



TE Part # 794058-1
MINI UMNL SOK L/P



TE Part # 770985-1
MINI UMNL PIN 26-22AWG SN LP



TE Part # 770903-3
MINI UMNL PIN 22-18 AWG AU



TE Part # 794059-1
MINI UMNL PIN L/P



TE Part # 1-770902-1
MINI UMNL SOK 26-22 AWG AU LF



TE Part # 770902-3
MINI UMNL SOK 26-22 AWG AU



TE Part # 1-770901-0
MINI UMNL PIN 26-22 AWG AU LF



TE Part # 1-770835-0
MINI UMNL PIN AU LF



TE Part # 1-770903-0
MINI UMNL PIN 22-18 AWG AU



TE Part # 770904-3
MINI UMNL SOK 22-18 AWG AU

Also in the Series | AMP CPC



Circular Connector Adapters(7)



Circular Connector Caps & Covers(16)



Circular Connector Hardware(3)



Circular Connector Keying Plugs(2)



Circular Power Connectors(459)



Connector Backshells(56)



Connector Seals & Cavity Plugs(36)



Connector Strain Relief(6)



Insertion & Extraction Tools(1)



Power Contacts(6)

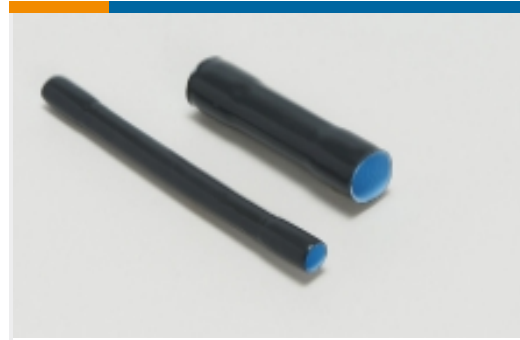

Sealing Sleeves(2)

Customers Also Bought



TE Part #DT04-12PB-P027
REC, 12P, BLK, BUSBAR 2X6, GOLD, B



TE Part #66260-2
MALE CONTACT ASSY. (L.P.)



TE Part #1-794610-1
MICRO MNL RPT CNT,LS PC 15AU L



TE Part #770986-1
MINI UMNL SOK 26-22AWG SN LP



TE Part #794058-1
MINI UMNL SOK L/P



TE Part #770985-1
MINI UMNL PIN 26-22AWG SN LP



TE Part #794059-1
MINI UMNL PIN L/P



TE Part #3-2176316-7
MELF SMA_A 100K 0.1% 15PPM 0207 1W

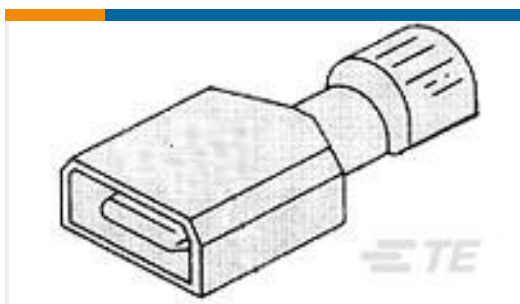

TE Part #3-520106-2
ULTRA-FAST 250 ASY TAB 16-14 AWG TPBR

Documents



Product Drawings

[PLUG,11-9,SM INS,STD KEY](#)

English

CAD Files

Customer View Model

[ENG_CVM_CVM_1445807-1_E1.2d_dxf.zip](#)

English

3D PDF

3D

Customer View Model

[ENG_CVM_CVM_1445807-1_E1.3d_igs.zip](#)

English

Customer View Model

[ENG_CVM_CVM_1445807-1_E1.3d_stp.zip](#)

English

By downloading the CAD file I accept and agree to the [Terms and Conditions](#) of use.

Datasheets & Catalog Pages

[1-1773902-9_CPC_Catalog](#)

English

[1-1773902-9_CPC_Catalog](#)

[1-1773902-9_CPC_Catalog](#)

German

[1-1773902-9_CPC_Catalog](#)

Japanese

[AMP Circular Connectors for Commercial Signal & Power Applications Continued](#)

English

Product Specifications

[Application Specification](#)

English