

Surface Mount 1575.42MHz SAW Filter

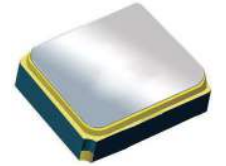

1.4 x 1.1 x 0.7 mm

AFS14A04-1575.42-T3

Moisture Sensitivity Level (MSL) = 3



RoHS
Compliant

- 1.4 x 1.1 x 0.7 mm low profile SMT package
- Low Insertion loss
- Excellent selectivity with high out-of-band rejection

- **APPLICATIONS:**
 - Wireless Communication
 - Remote Control
 - Cellular Phones

➤ ELECTRICAL SPECIFICATIONS:

Maximum Ratings

Item	Value
Input Power Level	+15 dBm max.
DC Permissive Voltage	3.0V DC max.
Operating Temperature Range	-40°C to + 85°C
Storage Temperature Range	-40°C to + 85°C

Parameters	Minimum	Typical	Maximum	Units	Notes
Center Frequency (f_c)		1575.42		MHz	
Insertion Loss (IL)		0.90	1.50	dB	(1574.42~1576.42 MHz)
Effective Bandwidth		40		MHz	
Amplitude Ripple		0.1	0.75	dB	(1574.42~1576.42 MHz)
Worst-Case Input / Output Return Loss		23	12.7	dB	(1574.42~1576.42 MHz)
Stop-band Attenuation (Referenced to 0.0 dB)	35	38		dB	D.C~1450 MHz
	30	45			1450~1520 MHz
	45	48			1625~1640 MHz
	38	40			1640~1805 MHz
	38	40			1805~1910 MHz
	38	43			1910~2000 MHz
	30	45			2000~4000 MHz
	20	22			4000~6000 MHz
Source Impedance (Z_S)		50		Ω	See note # 1
Load Impedance (Z_L)		50		Ω	See note # 1

Note #1: No matching network required for operation into 50 Ω 's

➤ TEST CIRCUIT:

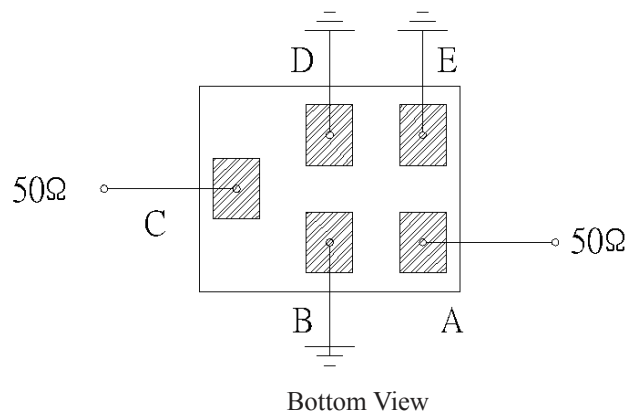

ABRACON IS
ISO 9001:2008
CERTIFIED



ABRACON
CORPORATION

Visit www.abracon.com for Terms & Conditions of Sale
30332 Esperanza, Rancho Santa Margarita, California 92688
tel 949-546-8000 | fax 949-546-8001 | www.abracon.com

Revised: 04.16.13

Surface Mount 1575.42MHz SAW Filter

AFS14A04-1575.42-T3



RoHS
Compliant

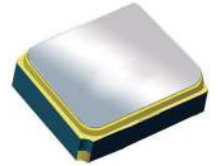

1.4 x 1.1 x 0.7 mm

FREQUENCY CHARACTERISTICS:

Filter Frequency Response (Narrowband)

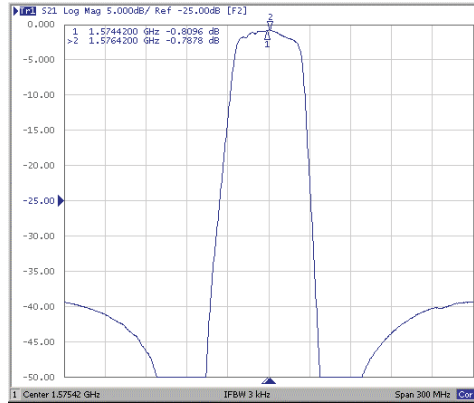

Filter Frequency Response (Wideband)

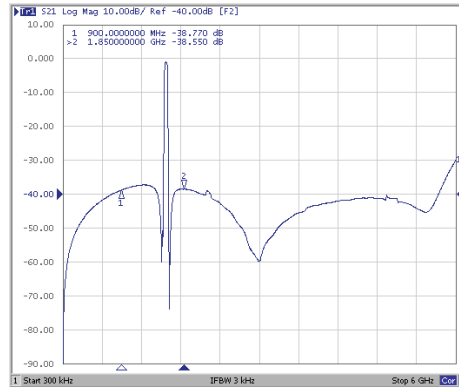

REFLECTION FUNCTIONS:

S11

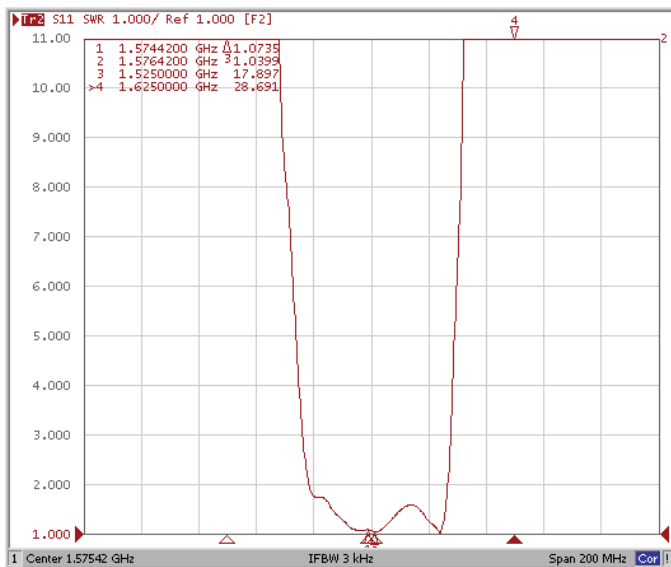

S22

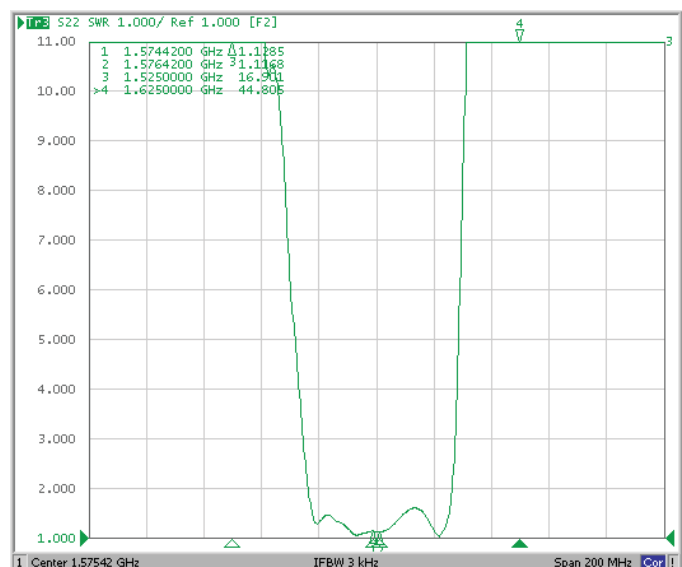

ABRACON IS
ISO 9001:2008
CERTIFIED



ABRACON
CORPORATION

Visit www.abracon.com for Terms & Conditions of Sale
30332 Esperanza, Rancho Santa Margarita, California 92688
tel 949-546-8000 | fax 949-546-8001 | www.abracon.com

Revised: 04.16.13

Surface Mount 1575.42MHz SAW Filter

AFS14A04-1575.42-T3



RoHS
Compliant

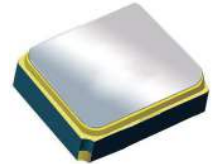

1.4 x 1.1 x 0.7 mm

REFLOW PROFILE:

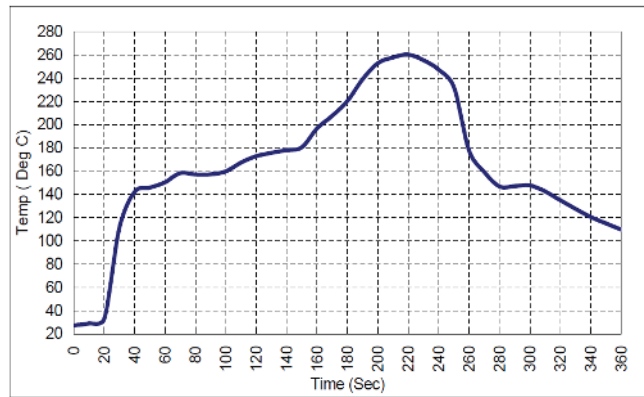

PACKAGING: 3000 Units/Reel “-T2” parts (2k/reel) are no longer available effective 01/01/2013

Reel Count : 7" = 3k units

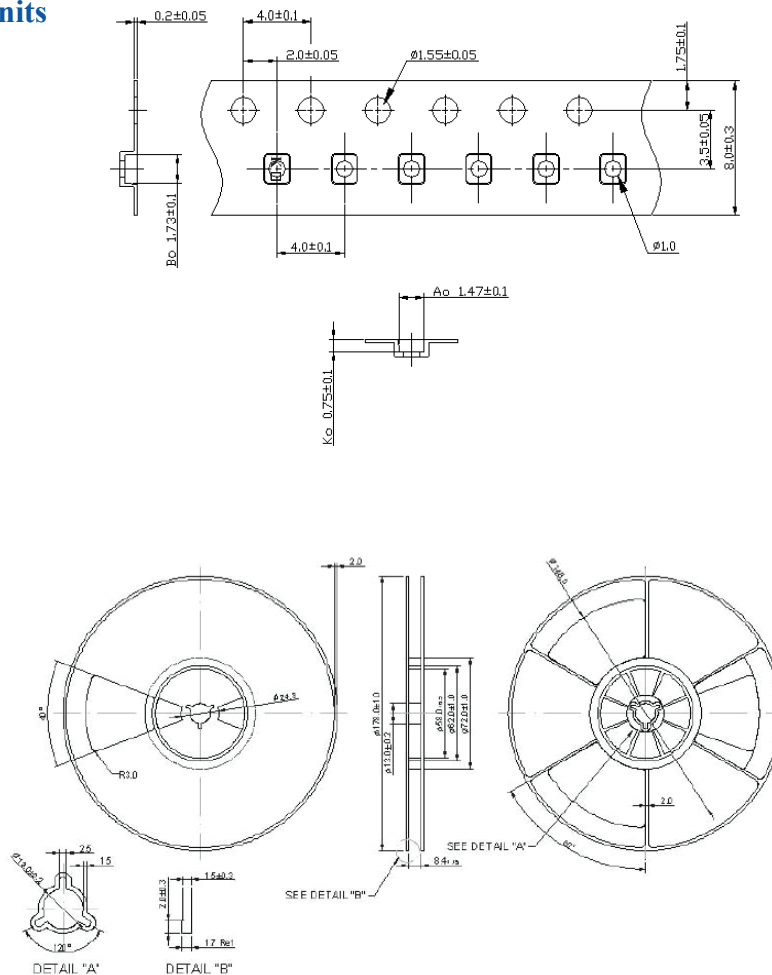

ATTENTION: Abracon Corporation's products are COTS – Commercial-Off-The-Shelf products; suitable for Commercial, Industrial and, where designated, Automotive Applications. Abracon's products are not specifically designed for Military, Aviation, Aerospace, Life-dependant Medical applications or any application requiring high reliability where component failure could result in loss of life and/or property. For applications requiring high reliability and/or presenting an extreme operating environment, written consent and authorization from Abracon Corporation is required. Please contact Abracon Corporation for more information.

ABRACON IS
ISO 9001:2008
CERTIFIED



Visit www.abracon.com for Terms & Conditions of Sale
30332 Esperanza, Rancho Santa Margarita, California 92688
tel 949-546-8000 | fax 949-546-8001 | www.abracon.com

Revised: 04.16.13