

PMC Panel Mount Power Supply

24 V 150 W 1 Phase (High Line) / PMC-24V150W2AA

PMC

Highlights & Features

- High line AC input range from 180 Vac to 264 Vac
- Power will not de-rate for the entire input voltage range
- Full corrosion resistant aluminium casing
- High MTBF > 700,000 hrs. per Telcordia SR-332
- Overvoltage / Overcurrent / Over Temperature Protections
- Safety approval according to IEC/UL 60950-1, IEC/EN/UL 62368-1 and EMI to EN 55032, Class B

Safety Standards



CB Certified for worldwide use



Model Number: PMC-24V150W2AA
Unit Weight: 0.50 kg (1.10 lb)
Dimensions (L x W x H): 178 x 97 x 38 mm
 (7.01 x 3.82 x 1.50 inch)

General Description

Delta's PMC series of panel mount power supply offers a nominal output voltage of 24 V, a wide temperature range from -10°C to +70°C and a highly dependable minimum hold-up time. The state-of-the-art design is made to withstand harsh industrial environments. What makes the product stands out from the crowd is its lightweight full aluminum body design, which can withstand shock and vibration according to IEC 60068-2. The PMC series also offers overvoltage and overload protection. Using a high line input voltage range design. The input also includes DC operating voltage from 220-375 Vdc. Best of all, this excellent design and quality does not come with a big price tag.

Model Information

PMC Panel Mount Power Supply

Model Number	Input Voltage Range	Output Voltage	Output Current
PMC-24V150W2AA	180-264 Vac (220-375 Vdc)	24 Vdc	6.25 A

Model Numbering

PMC	24 V	150 W	2	A	A
PMC Series	Output Voltage	Output Power	High Line Input	Delta Standard	Terminal Block

PMC Panel Mount Power Supply

24 V 150 W 1 Phase (High Line) / PMC-24V150W2AA

Specifications

Input Ratings / Characteristics

Nominal Input Voltage	200-240 Vac	
Input Voltage Range	180-264 Vac	
Nominal Input Frequency	50-60 Hz	
Input Frequency Range	47-63 Hz	
Nominal DC Input Voltage	220-250 Vdc	
DC Input Voltage Range*	220-375 Vdc	
Input Current	< 1.60 A @ 230 Vac	
Efficiency at 100% Load	> 87.0% @ 230 Vac	
Max Power Dissipation	0% load	< 1.5 W @ 230 Vac
	100% load	< 22.4 W @ 230 Vac
Max Inrush Current	< 120 A @ 230 Vac	
Leakage Current	< 1 mA @ 240 Vac	

*Safety approval according to IEC/UL 60950-1 and IEC/EN/UL 62368-1.

Output Ratings / Characteristics**

Nominal Output Voltage	24 Vdc
Factory Set Point Tolerance	24 Vdc \pm 2%
Output Voltage Adjustment Range	22-28 Vdc
Output Current	6.25 A (150 W max.)
Output Power	150 W
Line Regulation	< 0.5% (@ 170-264 Vac input, 100% load)
Load Regulation	< 1.0% (@ 170-264 Vac input, 0-100% load)
PARD *** (20 MHz)	<100 mVpp
Rise Time	< 30 ms @ nominal input (100% load)
Start-up Time	< 1000 ms @ nominal input (100% load)
Hold-up Time	> 20 ms @ 230 Vac (100% load)
Dynamic Response (Overshoot & Undershoot O/P Voltage)	\pm 5% @ 170-264 Vac input, 0-100% load (Slew Rate: 0.1 A/ μ s, 50% duty cycle @ 5 Hz)
Start-up with Capacitive Loads	8,000 μ F Max

**For power de-rating from 50°C to 70°C, see power de-rating on page 3.

***PARD is measured with an AC coupling mode, 5 cm wires, and in parallel with 0.1 μ F ceramic capacitor.

Mechanical

Case Cover	Aluminium	
Dimensions (L x W x H)	178 x 97 x 38 mm (7.01 x 3.82 x 1.50 inch)	
Unit Weight	0.50 kg (1.10 lb)	
Indicator	Green LED	DC OK
Cooling System	Convection	
Terminal	Input and Output	M3.5 x 7 Pins (Rated 300 V/15 A)
Wire	AWG 20-14	
Noise	Sound Pressure Level (SPL) <40 dBA	

PMC Panel Mount Power Supply

24 V 150 W 1 Phase (High Line) / PMC-24V150W2AA

Environment

Surrounding Air Temperature	Operating	-10°C to +70°C
	Storage	-25°C to +85°C
Power De-rating		> 50°C de-rate power by 2.5% / °C
Operating Humidity		5 to 95% RH (Non-Condensing)
Operating Altitude		0 to 3,000 Meters (9,840 ft)
Shock Test	Non-Operating	IEC60068-2-27, 30 G (300 m/S ²) for a duration of 18 ms 1 times per direction, 6 times in total
Vibration	Non-Operating	IEC60068-2-6, 10 Hz to 500 Hz @ 50 m/S ² (5G peak); 20 min per axis for all X, Y, Z direction
Over Voltage Category		II
Pollution Degree		2

Protections

Overvoltage	< 32 V ±10%, SELV output, Hiccup Mode, Non-Latching (Auto-Recovery).
Overload / Overcurrent	> 120% of rated load current, Hiccup Mode, Non-Latching (Auto-Recovery).
Over Temperature	< 75°C Ambient Temp@ 100% load, Non-Latching (Auto-Recovery).
Short Circuit	Hiccup Mode, Non-Latching (Auto-recovery when the fault is removed).
Internal Fuse at L pin	T3.15AH
Protection Against Shock	Class I with PE* connection

*PE: Primary Earth

Reliability Data

MTBF	> 700,000 hrs. as per Telcordia SR-332 I/P: 230 Vac, O/P: 100% load, Ta: 25°C
Expected Cap Life Time	10 years (230 Vac, 50% load @ 40°C)

PMC Panel Mount Power Supply

24 V 150 W 1 Phase (High Line) / PMC-24V150W2AA

Safety Standards / Directives

Safety Entry Low Voltage		SELV (IEC 60950-1)
Electrical Safety	TUV Bauart	EN 62368-1
	UL/cUL recognized	UL 60950-1 and CSA C22.2 No. 60950-1 (File No. E191395), UL 62368-1 and CSA C22.2 No. 62368-1 (File No. E191395)
	CB scheme	IEC 60950-1, IEC 62368-1
	UKCA	BS EN 62368-1
CCC		GB/T9254, GB 17625.1 and GB 4943.1 仅适用于海拔 2000m 以下地区安全使用
CE		In conformance with EMC Directive 2014/30/EU and Low Voltage Directive 2014/35/EU
UKCA		In conformance with Electrical Equipment (Safety) Regulations 2016 No. 1011 and The Electromagnetic Compatibility Regulations 2016 No. 1091
Galvanic Isolation	Input to Output	3.0 KVac
	Input to Ground	1.5 KVac
	Output to Ground	500 Vac

EMC

EMC / Emissions (CE & RE)		Generic Standards: CISPR32, EN/BS EN 55032, FCC Title 47: Class B, GB 9254
Immunity		Generic Standards: EN/BS EN 55024
Electrostatic Discharge	IEC 61000-4-2	Level 4 Criteria A ¹⁾ Air Discharge: 15 kV Contact Discharge: 8 kV
Radiated Field	IEC 61000-4-3	Level 3 Criteria A ¹⁾ 80 MHz-1 GHz, 10 V/M with 1 kHz tone / 80% modulation
Electrical Fast Transient / Burst	IEC 61000-4-4	Level 3 Criteria A ¹⁾ 2 kV
Surge	IEC 61000-4-5	Level 3 Criteria A ¹⁾ Common Mode ²⁾ : 2 kV Differential Mode ³⁾ : 2 kV
Conducted	IEC 61000-4-6	Level 3 Criteria A ¹⁾ 150 kHz-80 MHz, 10 Vrms
Power Frequency Magnetic Fields	IEC 61000-4-8	Criteria A ¹⁾ 10 A/Meter
Voltage Dips and Interruptions	IEC 61000-4-11	100% dip; 1 cycle (20 ms); Self Recoverable
Low Energy Pulse Test (Ring Wave)	IEC 61000-4-12	Level 3 Criteria A ¹⁾ Common Mode ²⁾ : 2 kV Differential Mode ³⁾ : 1 kV
Harmonic Current Emission		IEC/EN/BS EN 61000-3-2, Class A
Voltage Fluctuation and Flicker		IEC/EN/BS EN 61000-3-3

1) Criteria A: Normal performance within the specification limits

2) Asymmetrical: Common mode (Line to earth)

3) Symmetrical: Differential mode (Line to line)

PMC Panel Mount Power Supply

24 V 150 W 1 Phase (High Line) / PMC-24V150W2AA

Block Diagram

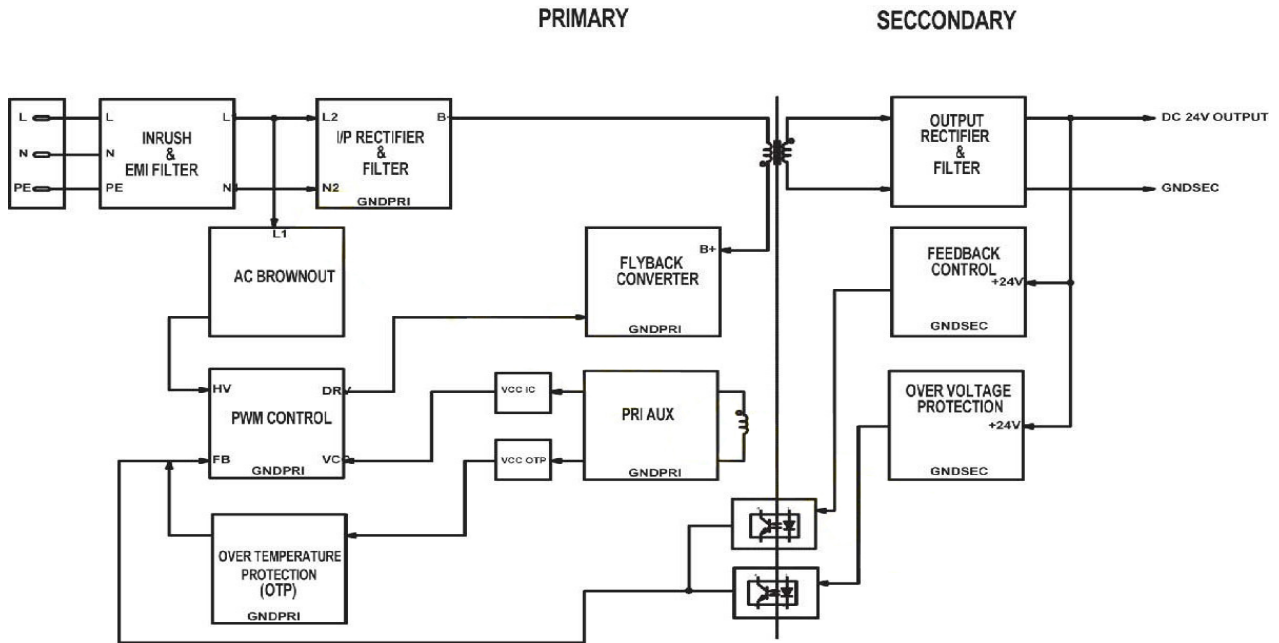

Device Description

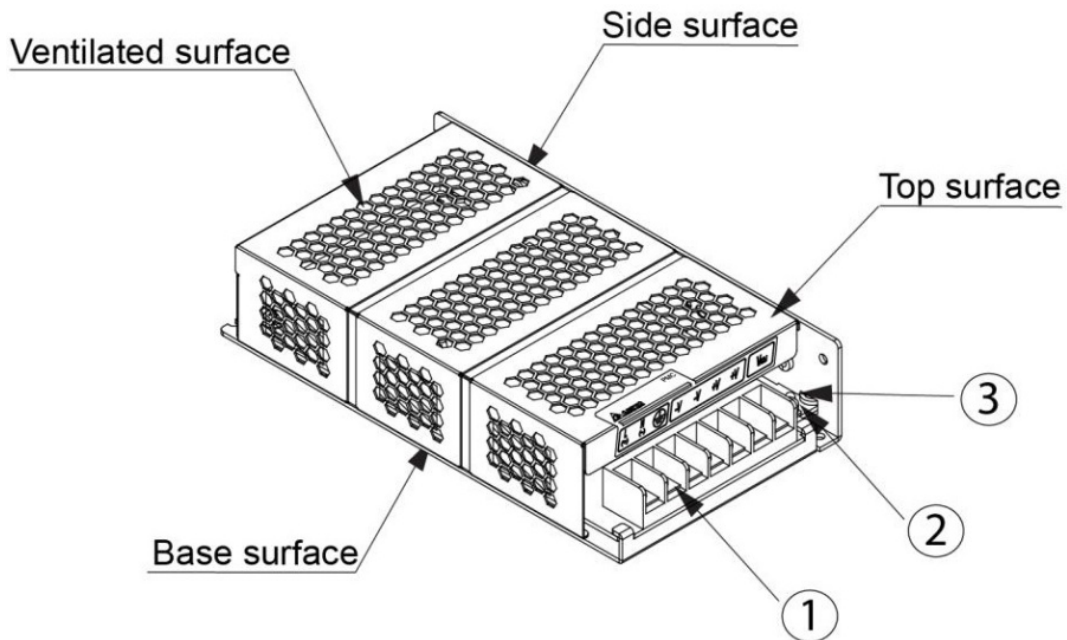

- 1) Input & Output terminal block connector
- 2) DC Voltage adjustment potentiometer
- 3) DC OK control LED (Green)

PMC Panel Mount Power Supply

24 V 150 W 1 Phase (High Line) / PMC-24V150W2AA

Dimensions

L x W x H: 178 x 97 x 38 mm (7.01 x 3.82 x 1.50 inch)

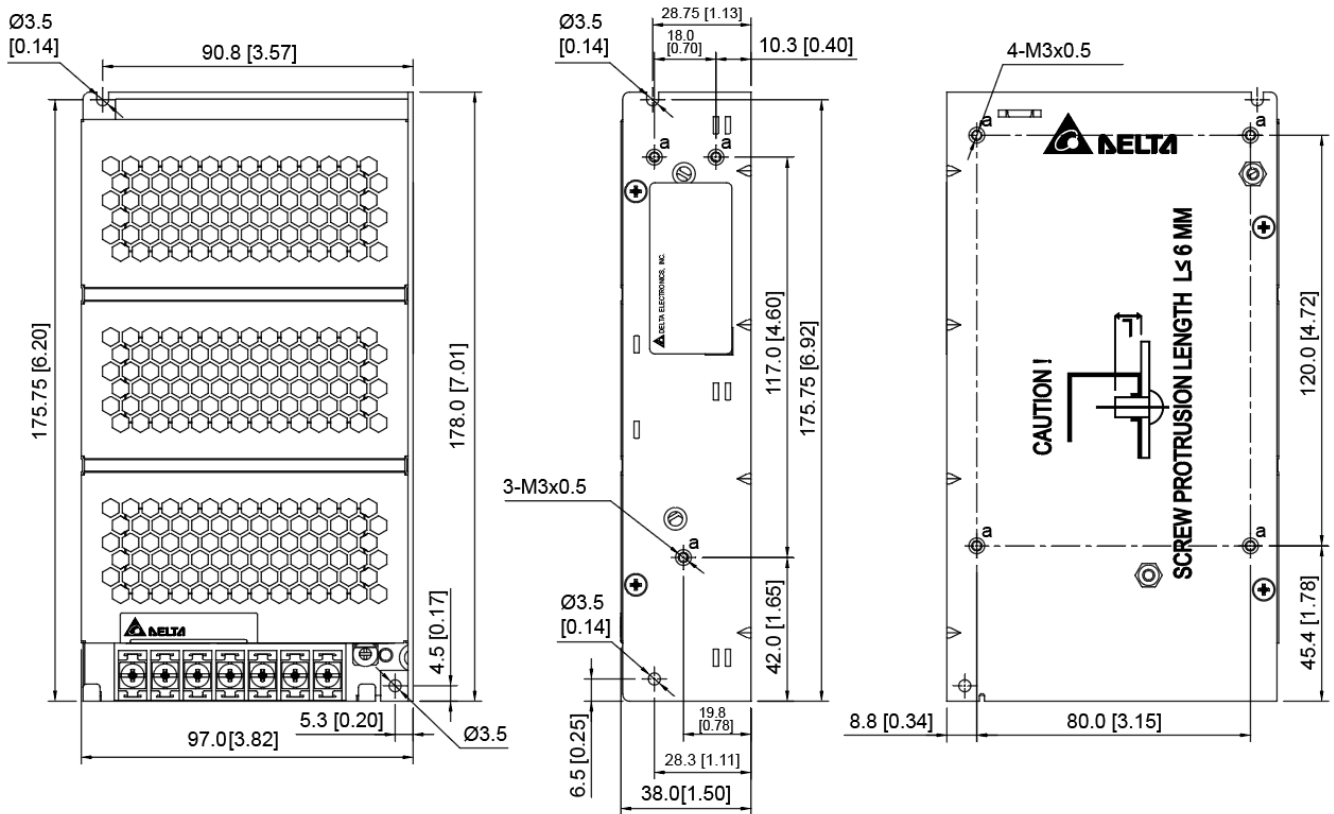

Engineering Data

Output Load De-rating VS Surrounding Air Temperature

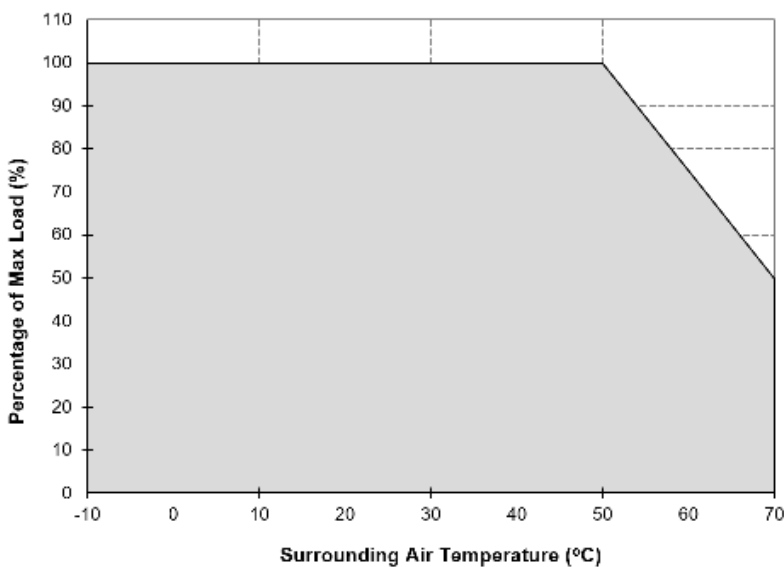

Fig. 1 De-rating for Vertical and Horizontal Mounting Orientation
 > 50°C de-rate power by 2.5% / °C

Note

1. Power supply components may degrade, or be damaged, when the power supply is continuously used outside the shaded region, refer to the graph shown in Fig. 1.
2. If the output capacity is not reduced when the surrounding air temperature exceeds its specification as defined on Page 3 under "Environment", the device may run into Over Temperature Protection. When activated, the output voltage will go into bouncing mode and will recover when the surrounding air temperature is lowered or the load is reduced as far as necessary to keep the device in working condition.
3. In order for the device to function in the manner intended, it is also necessary to keep a safety distance as recommended in the safety instructions while the device is in operation.
4. Depending on the surrounding air temperature and output load delivered by the power supply, the device can be very hot!
5. If the device has to be mounted in any other orientation, please contact info@deltapsu.com for more details.

PMC Panel Mount Power Supply

24 V 150 W 1 Phase (High Line) / PMC-24V150W2AA

Output Load De-rating VS Input Voltage

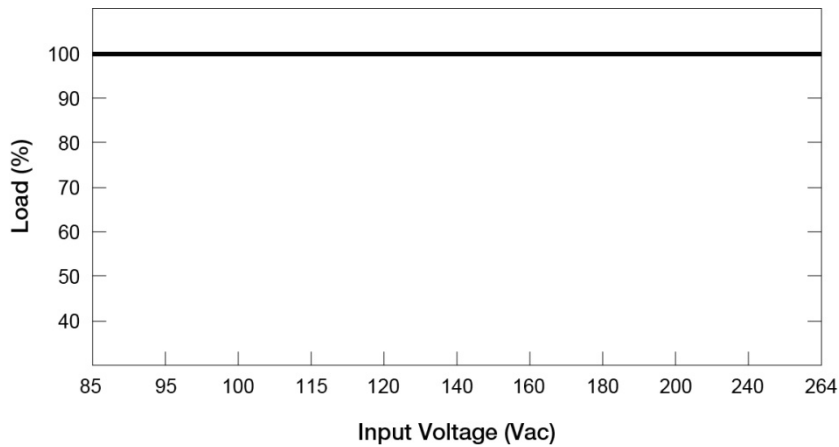

- No output power de-rating across the entire input voltage range

Assembly & Installation

Mounting

- Ⓐ Mounting holes for power supply assembly onto the mounting surface.
The power supply shall be mounted on minimum 2 mounting holes using M3 screw minimum 5 mm (0.20 inch) length.
- Ⓑ This surface belongs to customer's end system or panel where the power supply is mounted.
- Ⓒ Connector

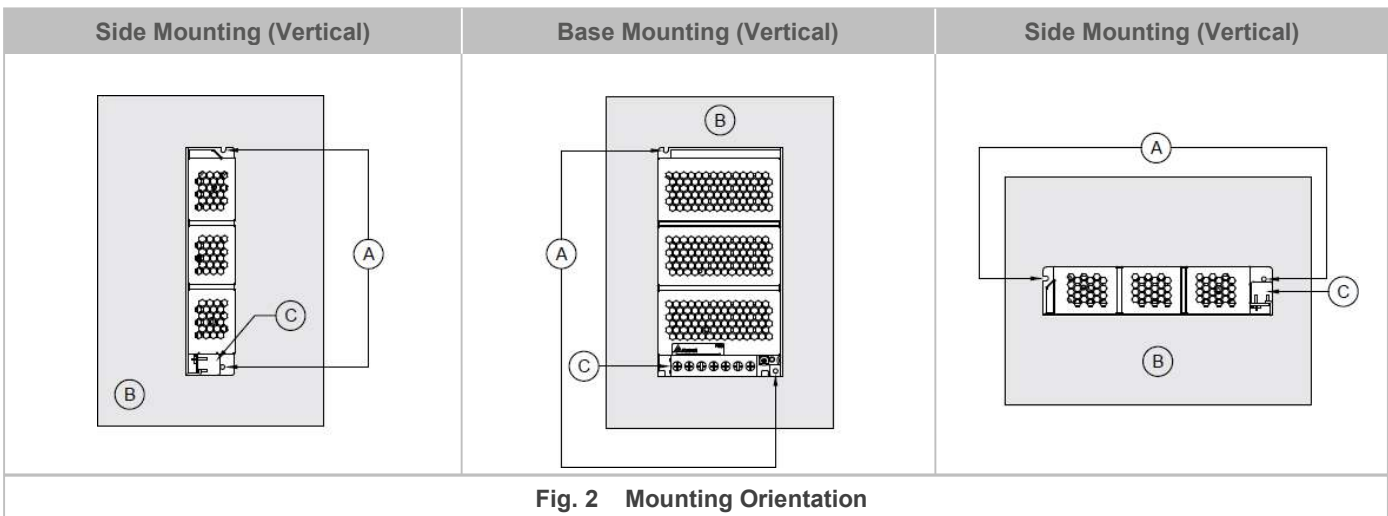

Fig. 2 Mounting Orientation

- Use flexible cable (stranded or solid) of AWG No. 20-14.
- The torque at the Connector shall not exceed 13 Kgf.cm (11.23 lb.in). The insulation stripping length should not exceed 0.275" or 7 mm.

PMC Panel Mount Power Supply

24 V 150 W 1 Phase (High Line) / PMC-24V150W2AA

Installation of Mounting Accessories

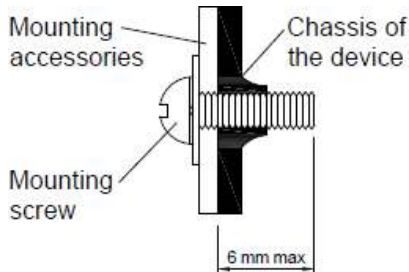

- Only use M3 screw ≤ 6 mm (0.24 inch) through the base mounting holes. This is to keep a safe distance between the screw and internal components.
- Recommended mounting tightening torque : 4~8 Kgf.cm (3.47~6.94 lbf.in).

Safety Instructions

- To ensure sufficient convection cooling, always maintain a safety distance of > 20 mm (0.79 inch) from all ventilated surfaces while the device is in operation.
- The device is not recommended to be placed on low thermal conductive surface, for example, plastics.
- Note that the enclosure of the device can become very hot depending on the ambient temperature and load of the power supply. Do not touch the device while it is in operation or immediately after power is turned OFF. Risk of burning!
- Do not touch the terminals while power is being supplied. Risk of electric shock.
- Prevent any foreign metal, particles or conductors to enter the device through the openings during installation. It can cause: -
- Electric shock; Safety Hazard; Fire; Product failure
- Warning: When connecting the device, secure Earth connection before connecting L and N. When disconnecting the device, remove L and N connections before removing the Earth connection.

Functions

■ Graph illustrating the Start-up Time, Rise Time, and Hold-up Time

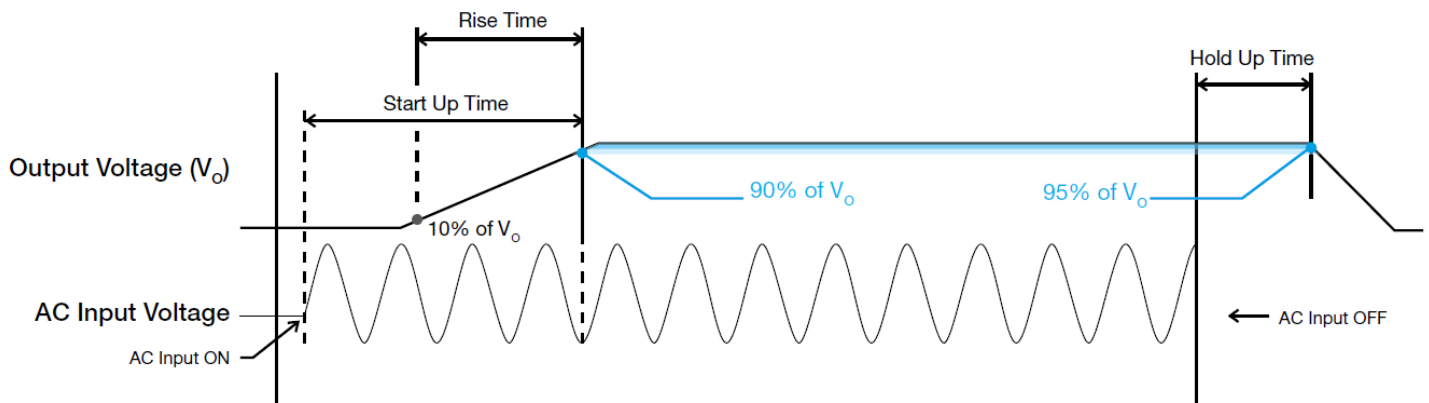

Start-up Time

The time required for the output voltage to reach 90% of its final steady state set value, after the input voltage is applied.

Rise Time

The time required for the output voltage to change from 10% to 90% of its final steady state set value.

Hold-up Time

Time between the collapse of the AC input voltage, and the output falling to 95% of its steady state set value.

PMC Panel Mount Power Supply

24 V 150 W 1 Phase (High Line) / PMC-24V150W2AA

Inrush Current

Inrush current is the peak, instantaneous, input current measured and, occurs when the input voltage is first applied. For AC input voltages, the maximum peak value of inrush current will occur during the first half cycle of the applied AC voltage. This peak value decreases exponentially during subsequent cycles of AC voltage.

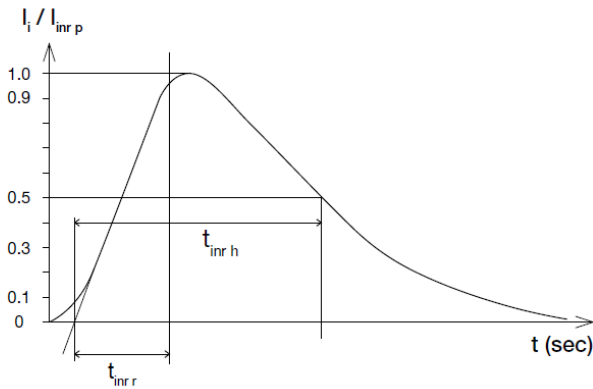

Overload & Overcurrent Protections (Auto-Recovery)

The power supply's Overload (OLP) and Overcurrent (OCP) Protections will be activated when output current (I_o) exceeds its specification as defined on Page 3 under "Protections". In such occurrence, the output voltage (V_o) will start to droop and once the power supply has reached its maximum power limit, the protection is activated and the power supply will go into "Hiccup mode" (Auto-Recovery). The power supply will recover once the fault condition of the OLP and OCP is removed and I_o is back within the specifications.

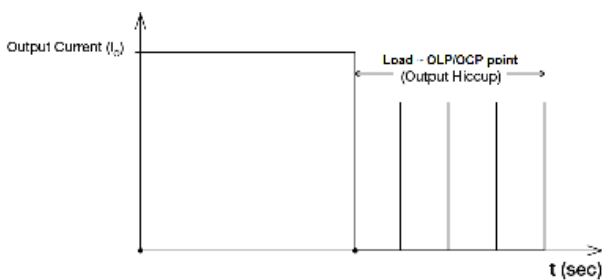

It is not recommended to prolong the duration of I_o when it is less than OLP/OCP point, but greater than 100%, since it may cause damage to the PSU.

Short Circuit Protection (Auto-Recovery)

The power supply's output OLP/OCP function also provides protection against short circuits. When a short circuit is applied, the output current will operate in "Hiccup mode", as shown in the illustration in the OLP/OCP section on this page. The power supply will return to normal operation after the short circuit is removed.

Dynamic Response

The power supply output voltage will remain within $\pm 5\%$ of its steady state value, when subjected to a dynamic load from 5% to 100% of its rated current.

■ 50% duty cycle / 5 Hz

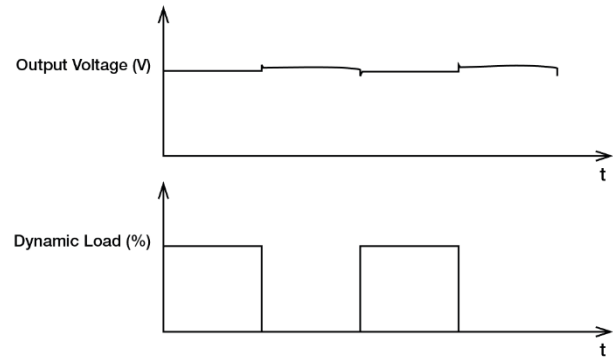

Overvoltage Protection (Auto-Recovery)

The power supply's overvoltage circuit will be activated when its internal feedback circuit fails. The output voltage shall not exceed its specifications defined on Page 3 under "Protections".

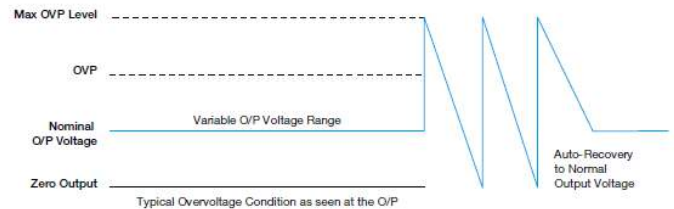

Over Temperature Protection (Auto-Recovery)

As mentioned above, the power supply also has Over Temperature Protection (OTP). In the event of a higher operating condition at 100% load, the power supply will run into OTP when the surrounding air temperature is beyond what is recommended in the de-rating graph. When activated, the output voltage will go into bouncing mode until the surrounding air temperature drops to its normal surrounding air temperature as recommended in the de-rating graph.

PMC Panel Mount Power Supply

24 V 150 W 1 Phase (High Line) / PMC-24V150W2AA

Operating Mode

■ Redundant Operation

In order to ensure proper redundant operation for the power supply units (PSUs), the output voltage difference between the two units must be kept at 0.45~0.50 V for these 24 V supplies. Follow simple steps given below to set them up for the redundant operation:

Step 1.

Measure output voltage of PSU 1 and PSU 2. If PSU 1 is the master unit, then V_O of PSU 1 must be higher than PSU 2. In order to set the output voltage, individually connect each power supply to 50% of rated load at any line voltage, and set the PSU 1 and PSU 2 output voltage.

Step 2.

Connect the power supply units PSU 1 and PSU 2 to V_{in1} & V_{in2} , respectively, of the DRR-20N (or 20A) module shown on the right of above diagram.

Step 3.

Connect the system load to V_{out} . Please note that output voltage V_{out} from DRR module will be $= V_O$ (output voltage of power supply) $- V_{drop}^*$ (in DRR module).

* V_{drop} will vary from 0.60 V to 0.90 V (Typical 0.65 V) depending on the load current and surrounding air temperature.

■ Parallel Operation

The power supply units (PSUs) can also be used for parallel operation in order to increase the output power. The difference in output voltage between the two units must be kept to within 25 mV of each other. This difference must be verified with the same output load connected independently to each unit.

Parameters such as EMI, inrush current, leakage current, PARD, start up time will be different from those on the datasheet, when two units are connected in parallel. The user will need to verify that any differences will still allow the two power supplies connected in parallel will work properly in their product/application.

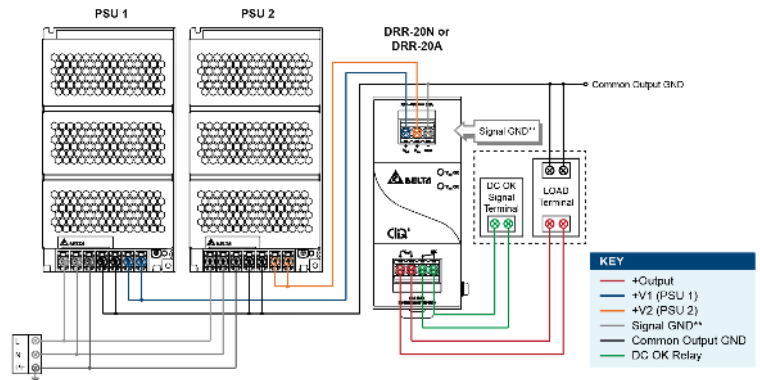

**The Signal GND in the DRR module is for the built-in LED and DC OK signals. The Output GND terminals from the two PSU's do not need to be connected to the Signal GND terminal.

Fig. 3 Redundant Operation Connection Diagram

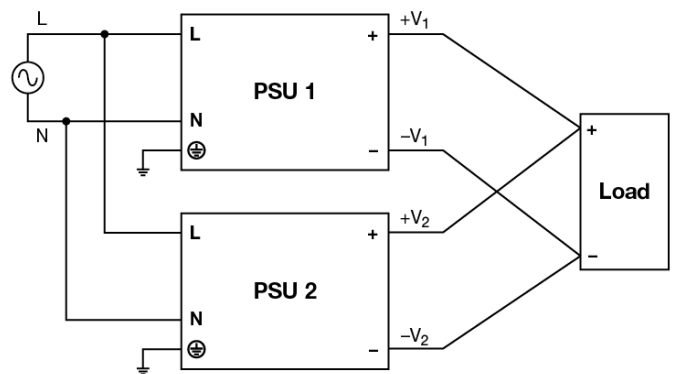

Fig. 4 Parallel Operation Connection Diagram

PMC Panel Mount Power Supply

24 V 150 W 1 Phase (High Line) / PMC-24V150W2AA

Others

PFC – Norm EN 61000-3-2

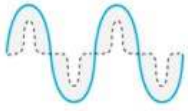

Line Current harmonic

Typically, the input current waveform is not sinusoidal due to the periodical peak charging of the input capacitor. In industrial environment, complying with EN 61000-3-2 is only necessary under special conditions. Complying to this standard can have some technical drawbacks, such as lower efficiency as well as some commercial aspects such as higher purchasing costs. Frequently, the user does not profit from fulfilling this standard, therefore, it is important to know whether it is mandatory to meet this standard for a specific application.

This product conforms to this standard.

Attention

Delta provides all information in the datasheets on an “AS IS” basis and does not offer any kind of warranty through the information for using the product. In the event of any discrepancy between the information in the catalog and datasheets, the datasheets shall prevail (please refer to www.DeltaPSU.com for the latest datasheets information). Delta shall have no liability of indemnification for any claim or action arising from any error for the provided information in the datasheets. Customer shall take its responsibility for evaluation of using the product before placing an order with Delta.

Delta reserves the right to make changes to the information described in the datasheets without notice.

Manufacturer and Authorized Representatives Information

Manufacturer

Thailand

Delta Electronics (Thailand) PCL.
909 Pattana 1 Rd., Muang, Samutprakarn, 10280 Thailand

Taiwan

Delta Electronics, Inc.
3 Tungyuan Road, Chungli Industrial Zone, Taoyuan County
32063, Taiwan

Authorized Representatives

The Netherlands

Delta Greentech (Netherlands) B.V.
Zandsteen 15, 2132 MZ Hoofddorp, The Netherlands

United Kingdom

Delta Electronics Europe Limited
1 Redwood Court, Peel Park Campus,
East Kilbride, Glasgow, G74 5PF, United Kingdom