

Grove - Multichannel Gas Sensor

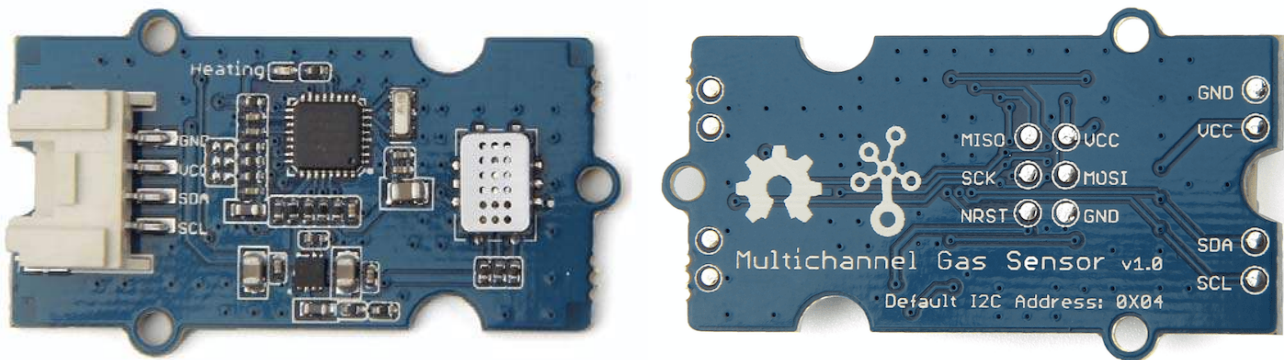

Grove – Multichannel Gas sensor is a environment detecting sensor with a built in MiCS-6814 which can detect many unhealthful gases, and three gases can be measured simultaneously due to its multi channels, so it can help you to monitor the concentration which more than one gas.

This sensor belongs to **Grove system**, and you can plug it onto the **Base shield** and work with Arduino directly without any jumper wires. The interface of it is I2C, so plug it onto the I2C port of Base shield, then you can start to work it.

Caution

The sensor value only reflects the approximated trend of gas concentration in a permissible error range, it DOES NOT represent the exact gas concentration. The detection of certain components in the air usually requires a more precise and costly instrument, which cannot be done with a single gas sensor. If your project is aimed at obtaining the gas concentration at a very precise level, then we do not recommend this gas sensor.

Tip

We've released the [Seeed Gas Sensor Selection Guide](#), it will help you choose the gas sensor that best suits your needs.

Before usage

Related Reading

We suggest you to read those knowledge before using the Gas sensor, it'll help you to learn more about Arduino and our products, and also it'll let you to use open source hardware more easier.

- [Getting Started with Arduino](#)
- [What is Grove system](#)
- [Why i need a Base shield?](#)

After reading that you will know how to use Base shield with Grove products to work well with Arduino. Let's start it !

To be prepared

This tutorial will include some necessary products:

- [Arduino UNO R3](#) or [Seeeduino v4](#)
- [Base Shield](#)
- Grove - Multichannel Gas Sensor

Hardware Overview

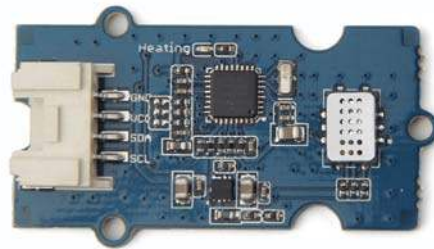

Four pins are pointed out from the figure above

Pin Label	Description
GND	Connect to ground
VCC	Power supply: 3.3V - 5V
SDA	I2C data
SCL	I2C clock

The power supply is between 3.3V and 5V, so this sensor can be compatible with a micro-controller whose output voltage is 3.3V.



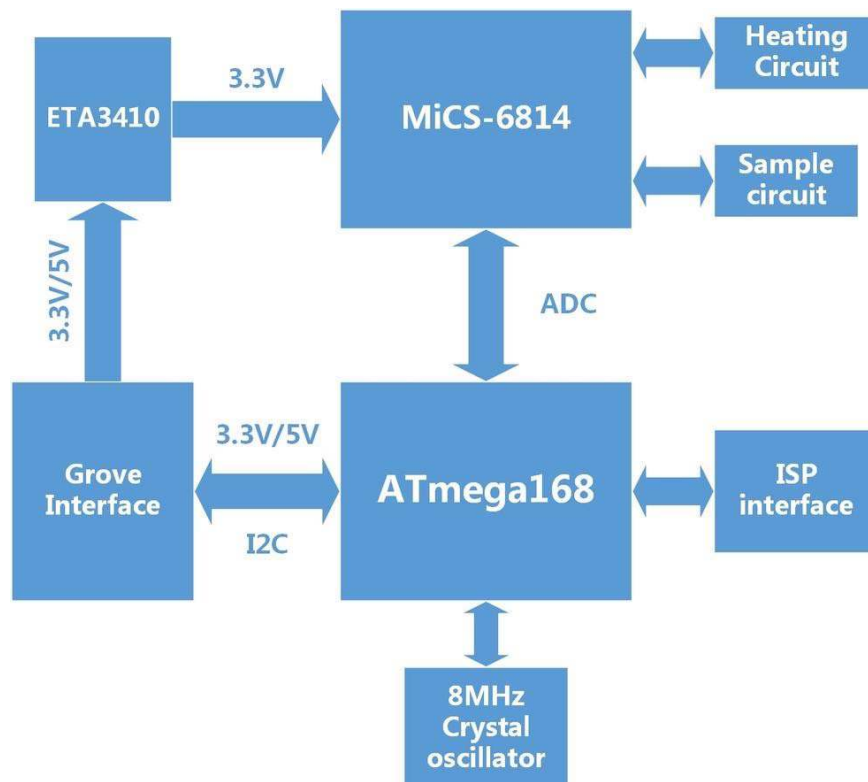

Features

- Three fully independent sensing elements on one package
- Built with ATmega168PA
- I2C interface with programmable address
- Heating power can be shut down for low power
- Detectable gases
 - Carbon monoxide CO 1 – 1000ppm
 - Nitrogen dioxide NO₂ 0.05 – 10ppm
 - Ethanol C₂H₆OH 10 – 500ppm
 - Hydrogen H₂ 1 – 1000ppm
 - Ammonia NH₃ 1 – 500ppm
 - Methane CH₄ >1000ppm
 - Propane C₃H₈ >1000ppm
 - Iso-butane C₄H₁₀ >1000ppm

Block Diagram



Platforms Supported

Arduino	Raspberry Pi	BeagleBone	Wio	LinkIt ONE
				

Caution

The platforms mentioned above as supported is/are an indication of the module's software or theoretical compatibility. We only provide software library or code examples for Arduino platform in most cases. It is not possible to provide software library / demo code for all possible MCU platforms. Hence, users have to write their own software library.

Electrical Characteristics

Item	Condition	Min.	Typ.	Max.	Unit
Voltage	-	3.1	3.3	5.25	V
Ripple	@Max Power	-	80	100	mV
Heating Power	-	-	-	88	mW
Max Power	-	-	-	150	mW
ADC Precision	-	-	10	-	Bits
I2C Rate	-	-	100	400	kHz
VIL	@I2C	-0.5	-	0.99	V
VIH	@I2C	2.31	-	5.25	V

Performance RED sensor

Characteristic RED sensor	Symbol	Typ	Min	Max	Unit
Sensing resistance in air	R0	-	100	1500	kΩ
Typical CO detection range	FS	-	1	1000	ppm
Sensitivity factor	SR	-	1.2	50	-

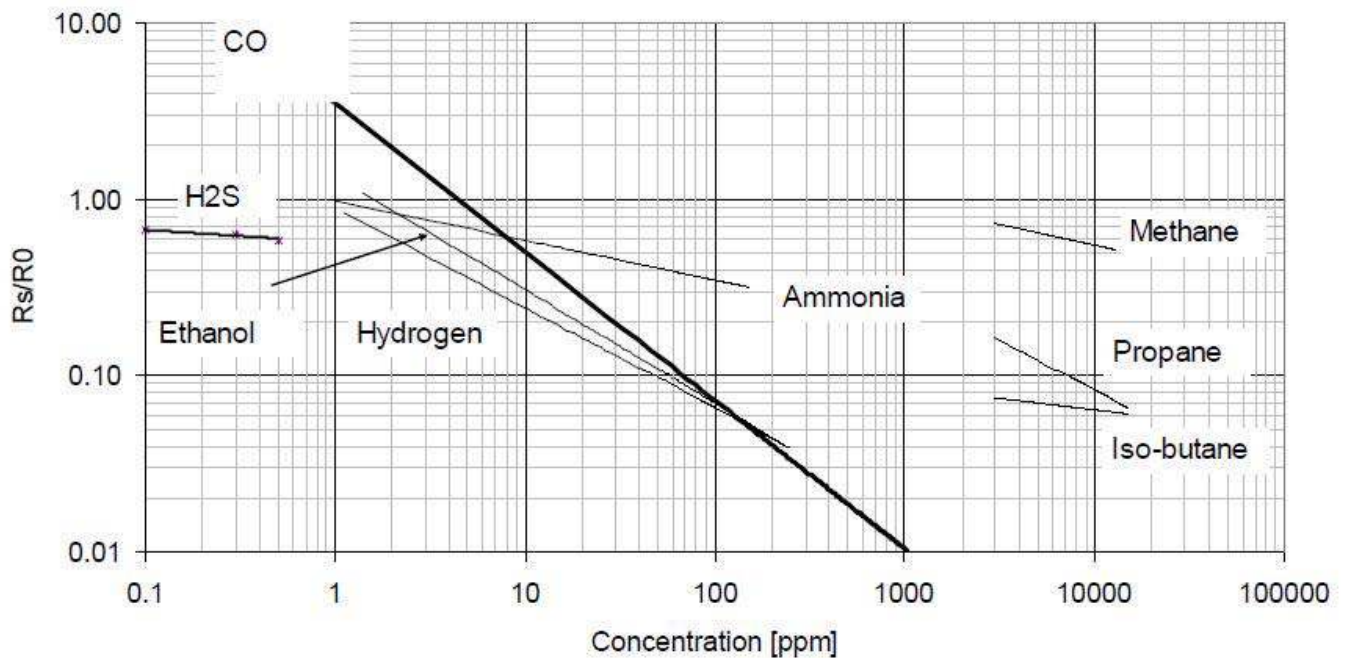

RED sensor, continuous power ON, 25°C, 50% RH

Performance OX sensor

Characteristic OX sensor	Symbol	Typ	Min	Max	Unit
Sensing resistance in air	R0	-	0.8	20	kΩ
Typical NO ₂ detection range	FS	-	0.05	10	ppm
Sensitivity factor	SR	-	2	-	-

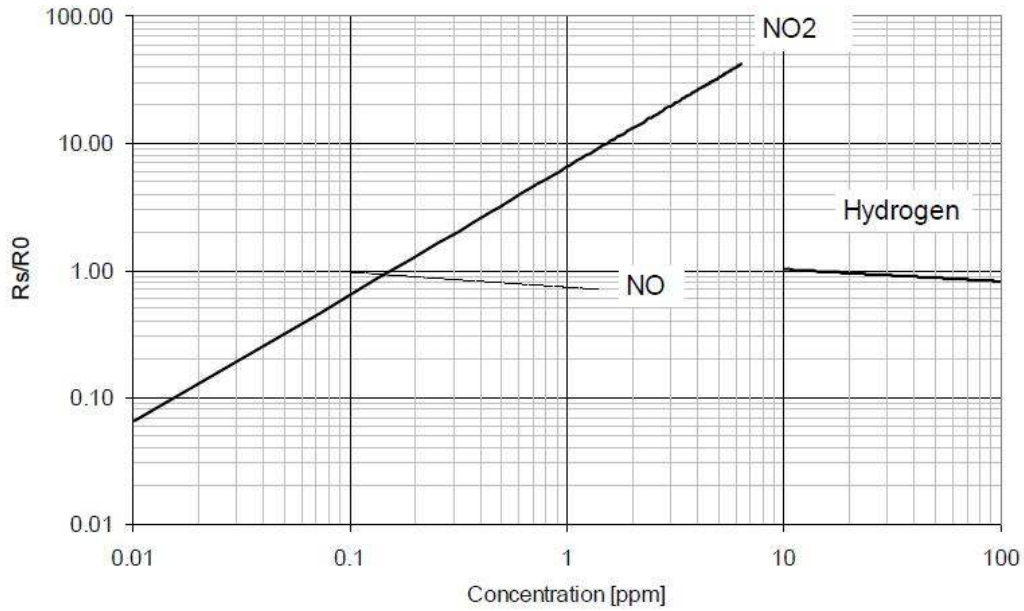

OX sensor, continuous power ON, 25°C, 50% RH

Performance NH3 sensor

Characteristic NH3 sensor	Symbol	Typ	Min	Max	Unit
Sensing resistance in air	R0	-	10	1500	kΩ
Typical NH3 detection range	FS	-	1	300	ppm
Sensitivity factor	SR	-	1.5	15	-

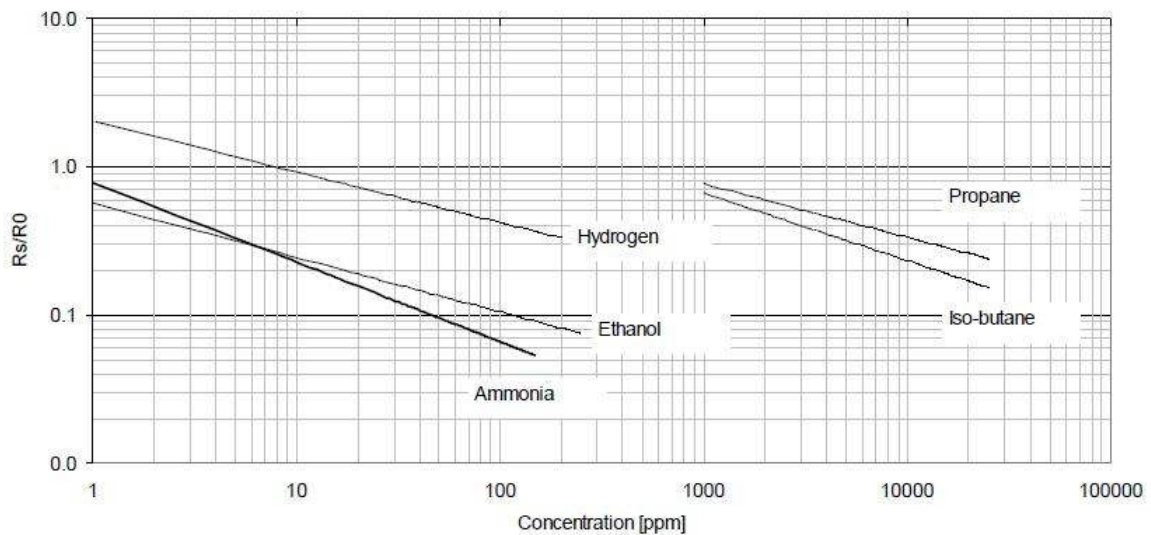

NH3 sensor, continuous power ON, 25°C, 50% RH

Getting Started

Warning

Then sensor need to preheat at least 10 minutes before getting a stable data.

Hardware Installation:

1.Connect Grove - Multichannel Gas Sensor to Seeeduino.

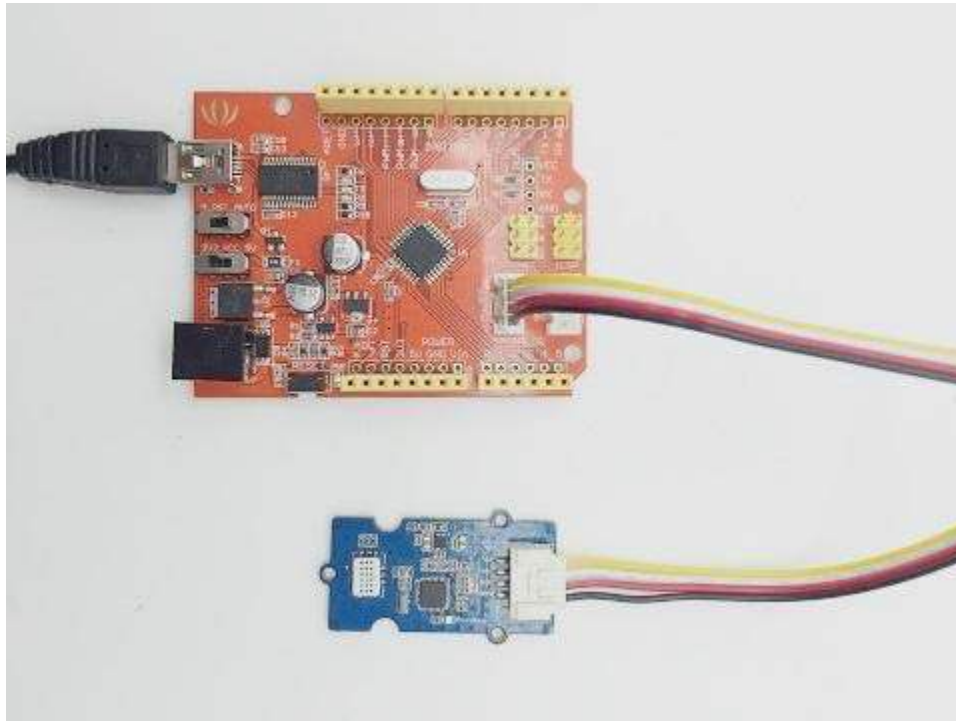

Upload Code:

2.Download [Arduino Library & Grove/Xadow firmware](#) and [install](#) it to Arduino Library.

3.Open the code directly by the path:File -> Example -> Mutichannel_Gas_Sensor-> ReadSensorValue_Grove.

The code of ReadSensorValue_Grove is given below.

```
1// Read Data from Grove - Multichannel Gas Sensor
2#include <Wire.h>
3#include "MutichannelGasSensor.h"
4
5void setup()
6{
7  Serial.begin(115200); // start serial for output
8  Serial.println("power on!");
9  gas.begin(0x04); //the default I2C address of the slave is 0x04
10 gas.powerOn();
11 Serial.print("Firmware Version = ");
12 Serial.println(gas.getVersion());
```

```
13}
14
15void loop()
16{
17   float c;
18
19   c = gas.measure_NH3();
20   Serial.print("The concentration of NH3 is ");
21   if(c>=0) Serial.print(c);
22   else Serial.print("invalid");
23   Serial.println(" ppm");
24
25   c = gas.measure_CO();
26   Serial.print("The concentration of CO is ");
27   if(c>=0) Serial.print(c);
28   else Serial.print("invalid");
29   Serial.println(" ppm");
30
31   c = gas.measure_NO2();
32   Serial.print("The concentration of NO2 is ");
33   if(c>=0) Serial.print(c);
34   else Serial.print("invalid");
35   Serial.println(" ppm");
36
37   c = gas.measure_C3H8();
38   Serial.print("The concentration of C3H8 is ");
39   if(c>=0) Serial.print(c);
40   else Serial.print("invalid");
41   Serial.println(" ppm");
42
43   c = gas.measure_C4H10();
44   Serial.print("The concentration of C4H10 is ");
45   if(c>=0) Serial.print(c);
46   else Serial.print("invalid");
47   Serial.println(" ppm");
48
49   c = gas.measure_CH4();
50   Serial.print("The concentration of CH4 is ");
51   if(c>=0) Serial.print(c);
52   else Serial.print("invalid");
53   Serial.println(" ppm");
54
55   c = gas.measure_H2();
56   Serial.print("The concentration of H2 is ");
57   if(c>=0) Serial.print(c);
58   else Serial.print("invalid");
59   Serial.println(" ppm");
60
61   c = gas.measure_C2H5OH();
62   Serial.print("The concentration of C2H5OH is ");
63   if(c>=0) Serial.print(c);
64   else Serial.print("invalid");
65   Serial.println(" ppm");
66
67   delay(1000);
68}
```

4. Upload the code. Remember to select Seeeduino Uno from the Tools | Board menu of the Arduino environment, and select the correct serial port Arduino is using.

By opening the serial monitor, you can see the raw data read from sensor.

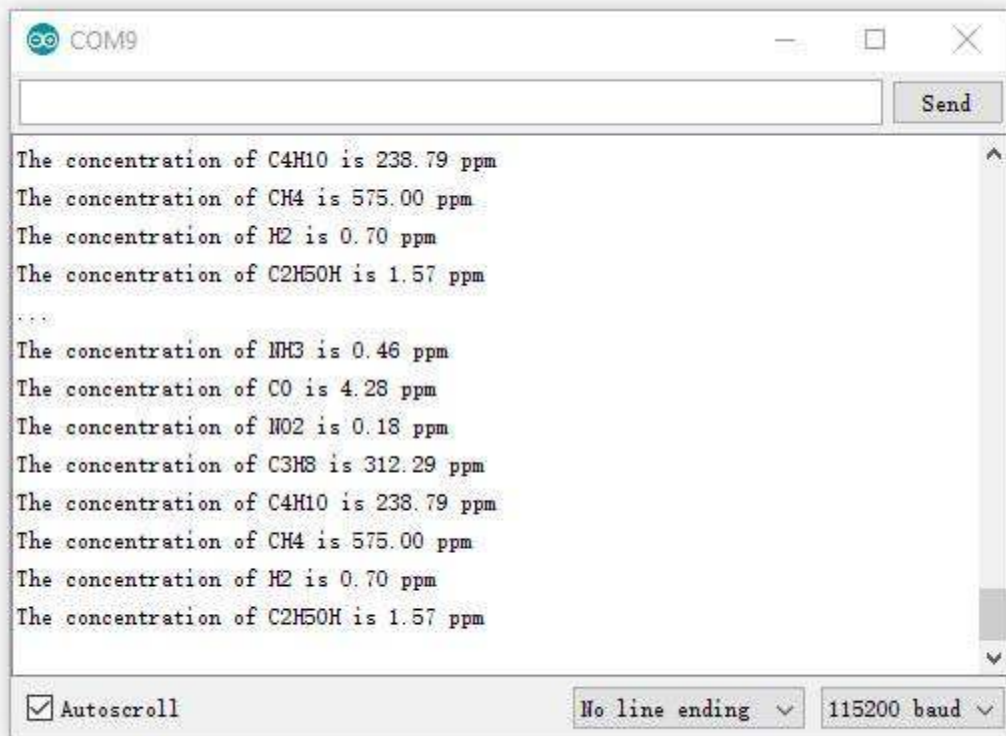

Tip

More details about Grove modules please refer to [Grove System](#)

Update Firmware

This grove module has an ATmega168 MCU which is flashed with a factory firmware. The version had been updated to V2 at Nov11/2016. Upload below code to detect the versin of your sensor.

```
1// Get firmware version of Grove Multichannel Gas Sensor
2#include <Wire.h>
3#include "MutichannelGasSensor.h"
4
5#define SENSOR_ADDR    0X04        // default to 0x04
6
7void setup()
8{
```

```
9   Serial.begin(115200);
10  gas.begin(SENSOR_ADDR);
11
12  unsigned char version = gas.getVersion();
13  Serial.print("Version = ");
14  Serial.println(version);
15}
16
17void loop()
18{
19    // nothing to do
20}
```

If the version of your sensor is V1, we advise you to upgrade it to V2 to get a better performance.

To update the firmware, you need,

- An Arduino UNO/Seeeduno V3/
- 6 dupont wire
- Soldering Iron

There's a ICSP pad on the back of the board, you need connect those pads to an Arduino board.

Sensor	Arduino
MISO	D12
SCK	D13
NRST	D10
GND	GND
MOSI	D11
VCC	5V

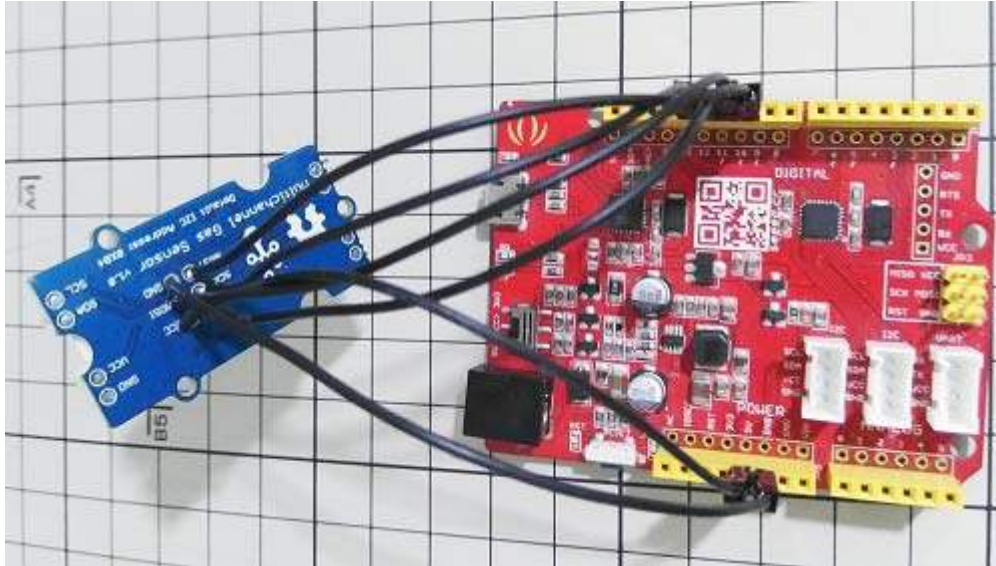

Then open the example **UpdateFirmware** to your Arduino, open Serial monitor and you will get some info printed. Input a 'g' to start.

```
COM9
Written.
Verifying ...

No errors found.
Writing fuses ...
LFuse = 0xC6
HFuse = 0xDE
EFuse = 0xF8
Lock byte = 0xCF
Clock calibration = 0x82
Done.
Type 'C' when ready to continue with another chip ...

 Autoscroll
No line ending
115200 baud
```

calibration

If you always get an unauthentic value, please try to calibrate the sensor. Open the example **calibration** and upload to your Arduino, open Serial monitor to get info when it's calibrating.

Note

The calibration has been done before the modules leave the factory. If you want to recalibrate, please do make sure that the air condition is fresh. And the calibration may need minutes to half an hour.

Resources

- [Grove - Multichannel Gas Sensor v1.0 sch](#)
- [Grove - Multichannel Gas Sensor eagle files](#)
- [Arduino Library & Grove/Xadow firmware](#)
- [MiCS-6814 Datasheet](#)