



RF Power Field Effect Transistors

N-Channel Enhancement-Mode Lateral MOSFETs

Designed for W-CDMA base station applications with frequencies from 2110 to 2170 MHz. Suitable for TDMA, CDMA and multicarrier amplifier applications. To be used in Class AB for PCN - PCS/cellular radio and WLL applications.

- Typical 2-Carrier W-CDMA Performance for $V_{DD} = 28$ Volts, $I_{DQ} = 1600$ mA, $f_1 = 2112.5$ MHz, $f_2 = 2122.5$ MHz, Channel bandwidth = 3.84 MHz, adjacent channels at ± 5 MHz, ACPR and IM3 measured in 3.84 MHz bandwidth. Peak/Avg. = 8.5 dB @ 0.01% probability on CCDF.
 - Output Power — 20 Watts
 - Efficiency — 18%
 - Gain — 13 dB
 - IM3 — -43 dBc
 - ACPR — -45 dBc
- Capable of Handling 5:1 VSWR, @ 28 Vdc, 2140 MHz, 125 Watts CW Output Power

Features

- Internally Matched for Ease of Use
- High Gain, High Efficiency and High Linearity
- Integrated ESD Protection
- Designed for Maximum Gain and Insertion Phase Flatness
- Excellent Thermal Stability
- Characterized with Series Equivalent Large-Signal Impedance Parameters
- RoHS Compliant
- In Tape and Reel. R3 Suffix = 250 Units per 56 mm, 13 inch Reel.

MRF21125R3
MRF21125SR3

2110-2170 MHz, 125 W, 28 V
LATERAL N-CHANNEL
RF POWER MOSFETs

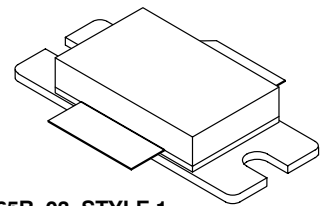

CASE 465B-03, STYLE 1
NI-880
MRF21125R3

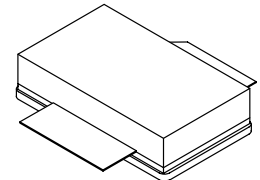

CASE 465C-02, STYLE 1
NI-880S
MRF21125SR3

Table 1. Maximum Ratings

Rating	Symbol	Value	Unit
Drain-Source Voltage	V_{DSS}	-0.5, +65	Vdc
Gate-Source Voltage	V_{GS}	-0.5, +15	Vdc
Total Device Dissipation @ $T_C = 25^\circ\text{C}$ Derate above 25°C	P_D	330 1.89	W W/ $^\circ\text{C}$
Storage Temperature Range	T_{stg}	- 65 to +150	$^\circ\text{C}$
Case Operating Temperature	T_C	150	$^\circ\text{C}$
Operating Junction Temperature	T_J	200	$^\circ\text{C}$

Table 2. Thermal Characteristics

Characteristic	Symbol	Value	Unit
Thermal Resistance, Junction to Case	$R_{\theta JC}$	0.53	$^\circ\text{C}/\text{W}$

ARCHIVE INFORMATION

ARCHIVE INFORMATION

Table 3. ESD Protection Characteristics

Test Conditions	Class
Human Body Model	2 (Minimum)
Machine Model	M3 (Minimum)

Table 4. Electrical Characteristics ($T_C = 25^\circ\text{C}$ unless otherwise noted)

Characteristic	Symbol	Min	Typ	Max	Unit
Off Characteristics					
Drain-Source Breakdown Voltage ($V_{GS} = 0 \text{ Vdc}$, $I_D = 100 \mu\text{A}$)	$V_{(BR)DSS}$	65	—	—	Vdc
Gate-Source Leakage Current ($V_{GS} = 5 \text{ Vdc}$, $V_{DS} = 0 \text{ Vdc}$)	I_{GSS}	—	—	1	μA
Zero Gate Voltage Drain Leakage Current ($V_{DS} = 28 \text{ Vdc}$, $V_{GS} = 0 \text{ Vdc}$)	I_{DSS}	—	—	10	μA
On Characteristics					
Forward Transconductance ($V_{DS} = 10 \text{ Vdc}$, $I_D = 3 \text{ A}$)	g_{fs}	—	10.8	—	S
Gate Threshold Voltage ($V_{DS} = 10 \text{ V}$, $I_D = 300 \mu\text{A}$)	$V_{GS(th)}$	2	—	4	Vdc
Gate Quiescent Voltage ($V_{DS} = 28 \text{ V}$, $I_D = 1300 \text{ mA}$)	$V_{GS(Q)}$	2.5	3.9	4.5	Vdc
Drain-Source On-Voltage ($V_{GS} = 10 \text{ V}$, $I_D = 1 \text{ A}$)	$V_{DS(on)}$	—	0.12	—	Vdc
Dynamic Characteristics					
Reverse Transfer Capacitance (1) ($V_{DS} = 28 \text{ Vdc}$, $V_{GS} = 0$, $f = 1 \text{ MHz}$)	C_{rss}	—	5.4	—	pF
Functional Tests (In Freescale Test Fixture, 50 ohm system) 2-carrier W-CDMA, 3.84 MHz Channel Bandwidth, IM3 measured in 3.84 MHz Bandwidth. Peak/Avg. = 8.5 dB @ 0.01% probability on CCDF.					
Common-Source Amplifier Power Gain ($V_{DD} = 28 \text{ Vdc}$, $P_{out} = 20 \text{ W Avg}$, 2-carrier W-CDMA, $I_{DQ} = 1600 \text{ mA}$, $f_1 = 2112.5 \text{ MHz}$, $f_2 = 2122.5 \text{ MHz}$ and $f_1 = 2157.5 \text{ MHz}$, $f_2 = 2167.5 \text{ MHz}$)	G_{ps}	12	13	—	dB
Drain Efficiency ($V_{DD} = 28 \text{ Vdc}$, $P_{out} = 20 \text{ W Avg}$, 2-carrier W-CDMA, $I_{DQ} = 1600 \text{ mA}$, $f_1 = 2112.5 \text{ MHz}$, $f_2 = 2122.5 \text{ MHz}$ and $f_1 = 2157.5 \text{ MHz}$, $f_2 = 2167.5 \text{ MHz}$)	η	17	18	—	%
Third Order Intermodulation Distortion ($V_{DD} = 28 \text{ Vdc}$, $P_{out} = 20 \text{ W Avg}$, 2-carrier W-CDMA, $I_{DQ} = 1600 \text{ mA}$, $f_1 = 2112.5 \text{ MHz}$, $f_2 = 2122.5 \text{ MHz}$ and $f_1 = 2157.5 \text{ MHz}$, $f_2 = 2167.5 \text{ MHz}$; IM3 measured at $f_1 - 10 \text{ MHz}$ and $f_2 + 10 \text{ MHz}$ referenced to carrier channel power.)	IM3	—	-43	-40	dBc
Adjacent Channel Power Ratio ($V_{DD} = 28 \text{ Vdc}$, $P_{out} = 20 \text{ W Avg}$, 2-carrier W-CDMA, $I_{DQ} = 1600 \text{ mA}$, $f_1 = 2112.5 \text{ MHz}$, $f_2 = 2122.5 \text{ MHz}$ and $f_1 = 2157.5 \text{ MHz}$, $f_2 = 2167.5 \text{ MHz}$; ACPR measured at $f_1 - 5 \text{ MHz}$ and $f_2 + 5 \text{ MHz}$ referenced to carrier channel power.)	ACPR	—	-45	-40	dBc
Input Return Loss ($V_{DD} = 28 \text{ Vdc}$, $P_{out} = 20 \text{ W Avg}$, 2-carrier W-CDMA, $I_{DQ} = 1600 \text{ mA}$, $f_1 = 2112.5 \text{ MHz}$, $f_2 = 2122.5 \text{ MHz}$ and $f_1 = 2157.5 \text{ MHz}$, $f_2 = 2167.5 \text{ MHz}$)	IRL	—	-12	-9.0	dB

1. Part internally matched both on input and output.

(continued)

Table 4. Electrical Characteristics ($T_C = 25^\circ\text{C}$ unless otherwise noted) (continued)

Characteristic	Symbol	Min	Typ	Max	Unit
Typical Two-Tone Performance (In Freescale Test Fixture)					
Common-Source Amplifier Power Gain ($V_{DD} = 28\text{ Vdc}$, $P_{out} = 125\text{ W PEP}$, $I_{DQ} = 1600\text{ mA}$, $f_1 = 2110\text{ MHz}$, $f_2 = 2120\text{ MHz}$ and $f_1 = 2160\text{ MHz}$, $f_2 = 2170\text{ MHz}$)	G_{ps}	—	12	—	dB
Drain Efficiency ($V_{DD} = 28\text{ Vdc}$, $P_{out} = 125\text{ W PEP}$, $I_{DQ} = 1600\text{ mA}$, $f_1 = 2110\text{ MHz}$, $f_2 = 2120\text{ MHz}$ and $f_1 = 2160\text{ MHz}$, $f_2 = 2170\text{ MHz}$)	η	—	34	—	%
Intermodulation Distortion ($V_{DD} = 28\text{ Vdc}$, $P_{out} = 125\text{ W PEP}$, $I_{DQ} = 1600\text{ mA}$, $f_1 = 2110\text{ MHz}$, $f_2 = 2120\text{ MHz}$ and $f_1 = 2160\text{ MHz}$, $f_2 = 2170\text{ MHz}$)	IMD	—	-30	—	dBc
Typical CW Performance					
Common-Source Amplifier Power Gain ($V_{DD} = 28\text{ Vdc}$, $P_{out} = 125\text{ W CW}$, $I_{DQ} = 1600\text{ mA}$, $f = 2170.0\text{ MHz}$)	G_{ps}	—	11.5	—	dB
Drain Efficiency ($V_{DD} = 28\text{ Vdc}$, $P_{out} = 125\text{ W CW}$, $I_{DQ} = 1600\text{ mA}$, $f = 2170.0\text{ MHz}$)	η	—	46	—	%

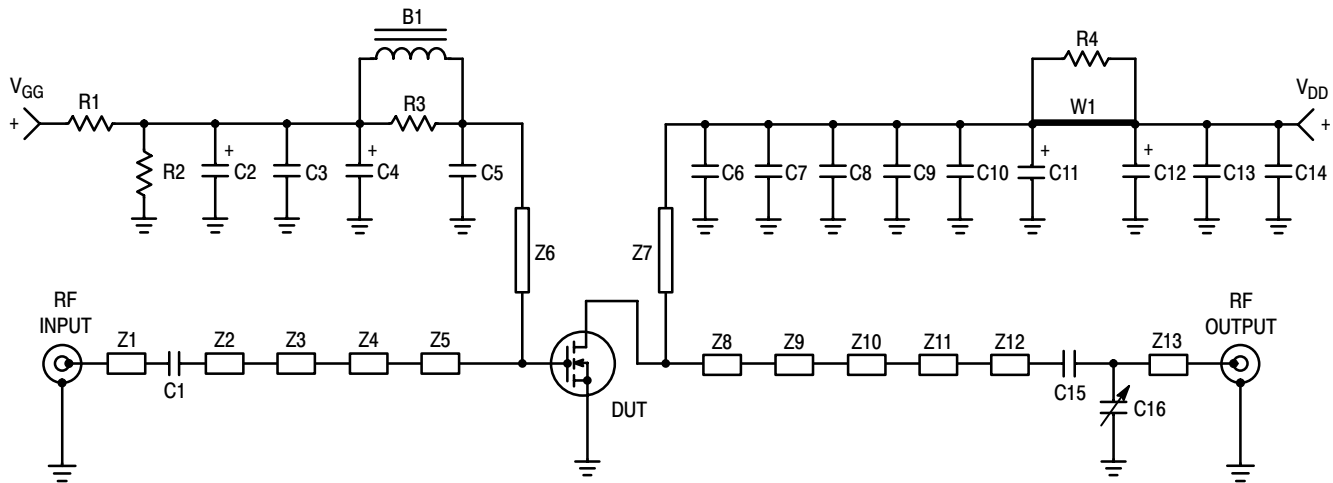

Z1	1.212" x 0.082" Microstrip	Z8	0.600" x 1.056" Microstrip
Z2	0.236" x 0.082" Microstrip	Z9	0.179" x 0.219" Microstrip
Z3	0.086" x 0.254" Microstrip	Z10	0.100" x 0.336" Microstrip
Z4	0.357" x 0.082" Microstrip	Z11	0.534" x 0.142" Microstrip
Z5	0.274" x 1.030" Microstrip	Z12	0.089" x 0.080" Microstrip
Z6	0.466" x 0.050" Microstrip	Z13	0.620" x 0.080" Microstrip
Z7	0.501" x 0.050" Microstrip	PCB	Arlon GX0300-55-22, 0.030", $\epsilon_r = 2.55$

Figure 1. MRF21125 Test Circuit Schematic

Table 5. MRF21125 Test Circuit Component Designations and Values

Designators	Description
B1	Ferrite Bead (Square), Fair Rite #2743019447
C1	9.1 pF Chip Capacitor, ATC #100B9R1CCA500X
C2, C4, C11, C12	22 μ F, 35 V Tantalum Surface Mount Chip Capacitors, Kemet #T491X226K035AS4394
C3, C7	20000 pF Chip Capacitors, ATC #100B203JCA50X
C5, C14	5.1 pF Chip Capacitors, ATC #100B5R1CCA500X
C6	100000 pF Chip Capacitor, ATC #100B104JCA50X
C8	10000 pF Chip Capacitor, ATC #100B103JCA50X
C9	7.5 pF Chip Capacitor, ATC #100B7R5CCA500X
C10	1.2 pF Chip Capacitor, ATC #100B1R2CCA500X
C13	0.1 μ F Chip Capacitor, Kemet #CDR33BX104AKWS
C15	16 pF Chip Capacitor, ATC #100B160KP500X
C16	0.6 - 4.5 pF Variable Capacitor, Johanson Gigatrim #27271SL
R1	1.0 k Ω , 1/8 W Chip Resistor
R2	560 k Ω , 1/8 W Chip Resistor
R3	4.7 Ω , 1/8 W Chip Resistor
R4	12 Ω , 1/8 W Chip Resistor
W1	Solid Copper Buss Wire, 16 AWG

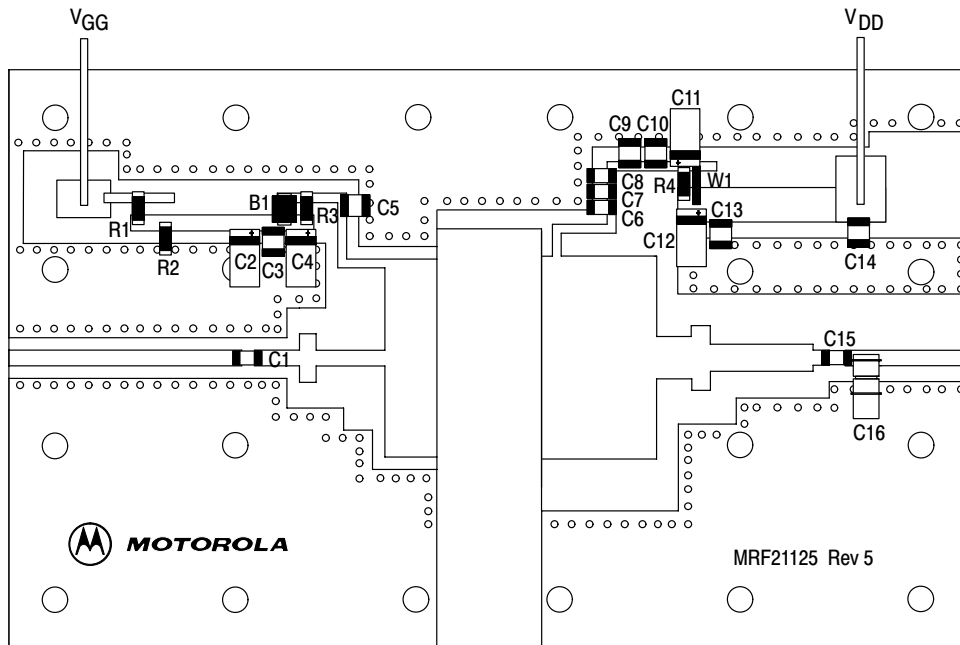

Freescall has begun the transition of marking Printed Circuit Boards (PCBs) with the Freescall Semiconductor signature/logo. PCBs may have either Motorola or Freescall markings during the transition period. These changes will have no impact on form, fit or function of the current product.

Figure 2. MRF21125 Test Circuit Component Layout

TYPICAL CHARACTERISTICS

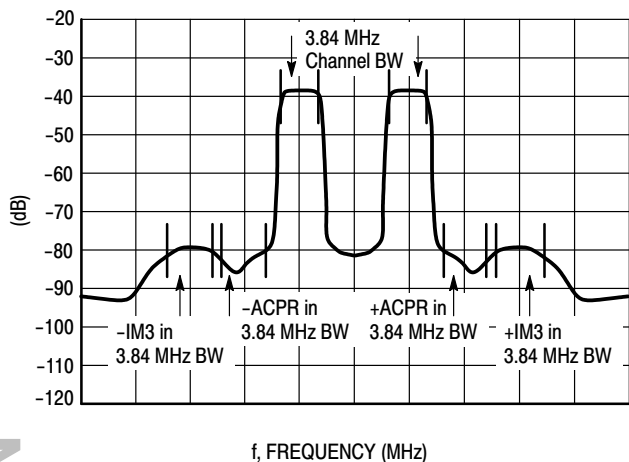

Figure 3. 2-Carrier (10 MHz Spacing) W-CDMA Spectrum

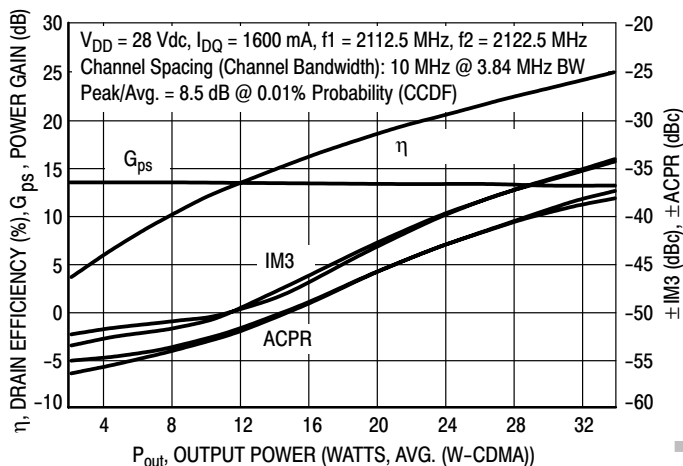

Figure 4. 2-Carrier W-CDMA ACPR, IM3, Power Gain and Drain Efficiency versus Output Power

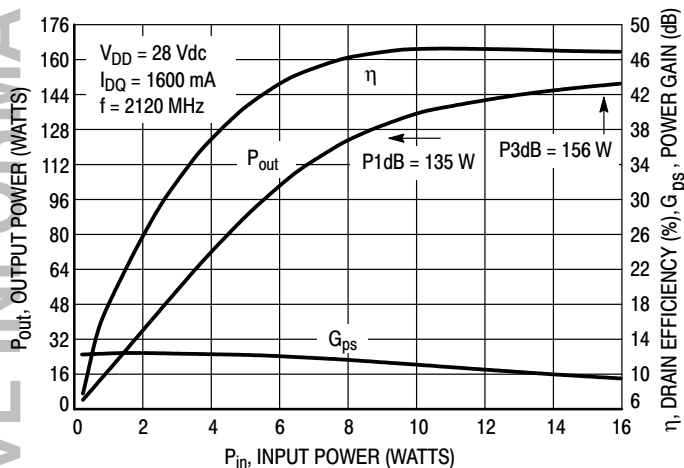

Figure 5. CW Performance

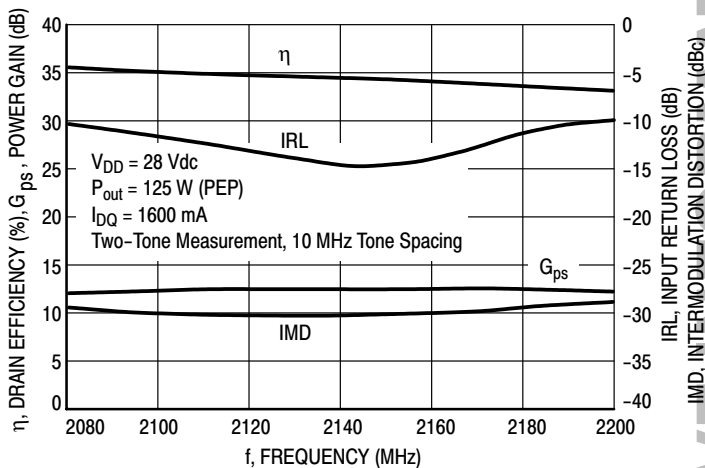

Figure 6. Broadband Linearity Performance

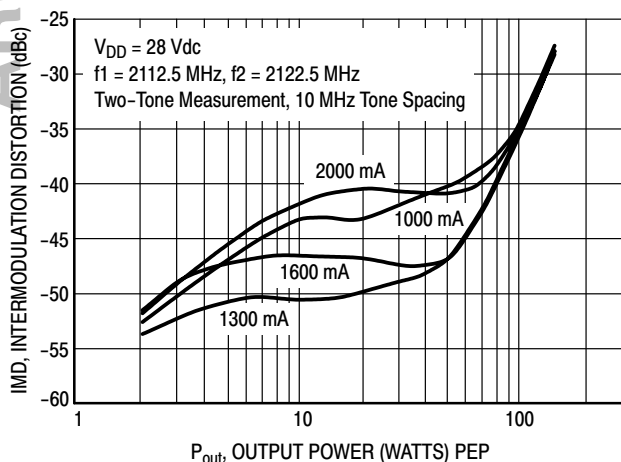

Figure 7. Intermodulation Distortion versus Output Power

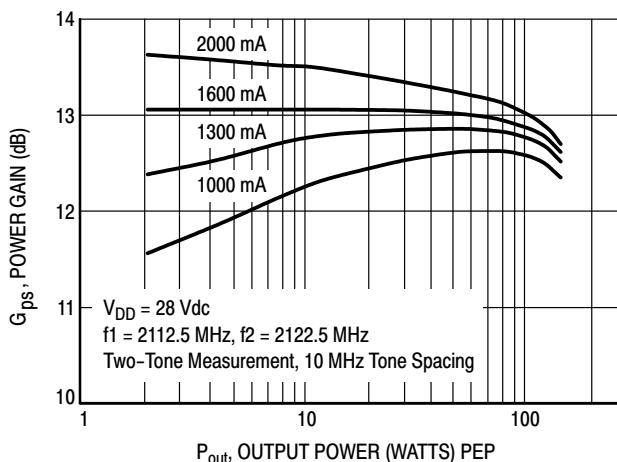
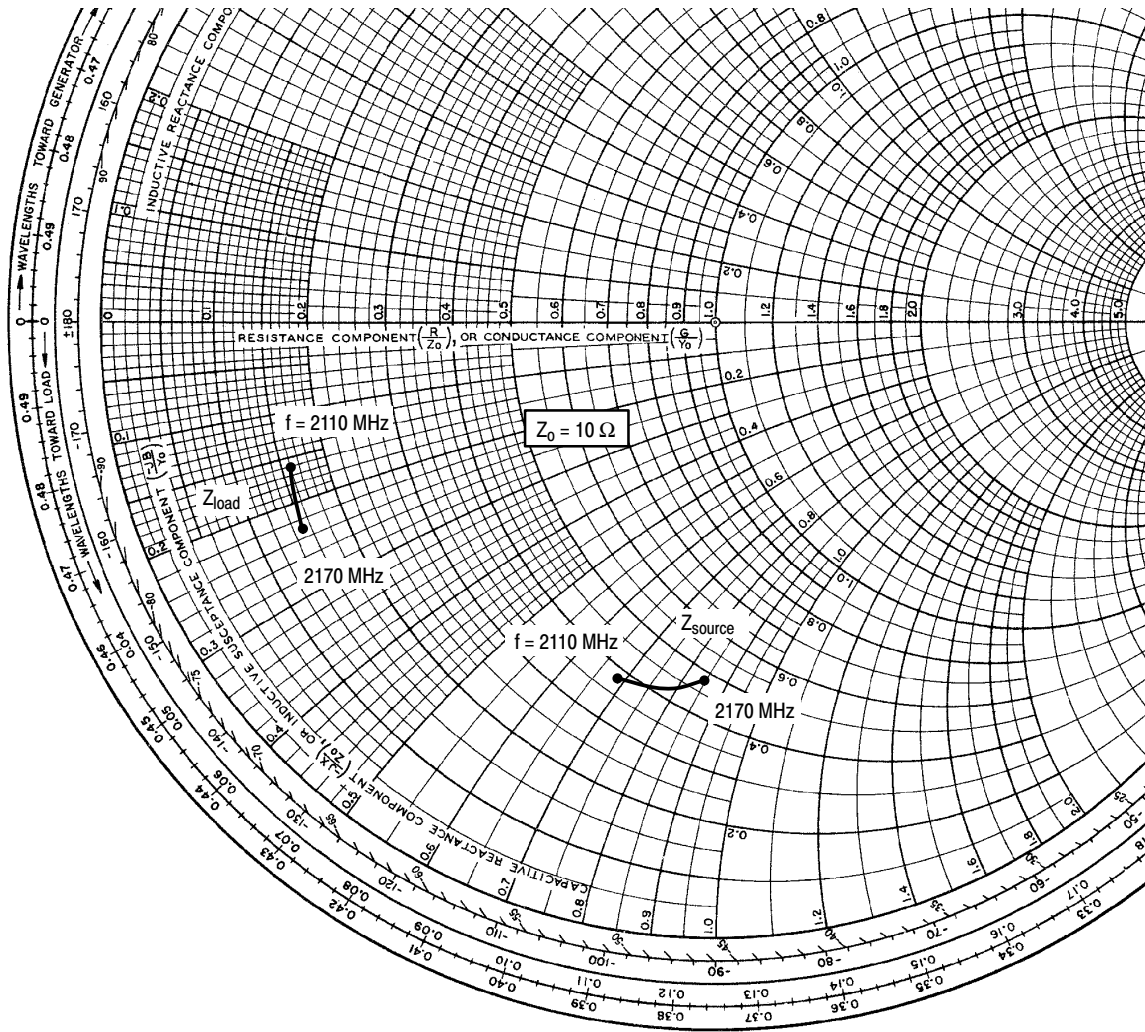

Figure 8. Power Gain versus Output Power



$V_{DD} = 28\text{ V}$, $I_{DQ} = 1600\text{ mA}$, $P_{out} = 20\text{ W (Avg.)}$, 2-Carrier W-CDMA

f MHz	Z_{source} Ω	Z_{load} Ω
2110	$3.81 - j6.86$	$1.56 - j1.58$
2140	$4.33 - j7.90$	$1.53 - j1.90$
2170	$4.84 - j8.46$	$1.48 - j2.26$

Z_{source} = Test circuit impedance as measured from gate to ground.

Z_{load} = Test circuit impedance as measured from drain to ground.

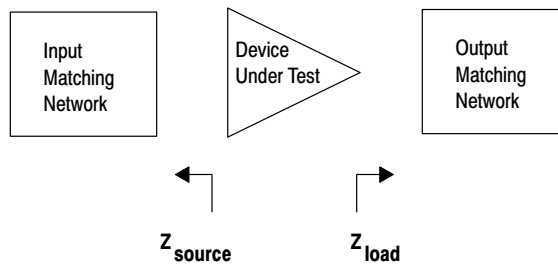

Figure 9. Series Equivalent Source and Load Impedance

NOTES

ARCHIVE INFORMATION

ARCHIVE INFORMATION

NOTES

ARCHIVE INFORMATION

ARCHIVE INFORMATION

NOTES

ARCHIVE INFORMATION

ARCHIVE INFORMATION

PACKAGE DIMENSIONS

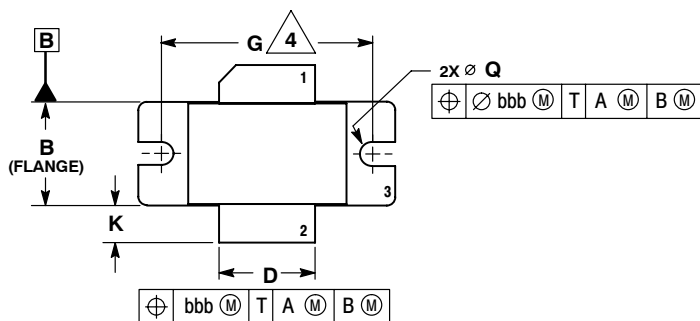

- NOTES:
1. DIMENSIONING AND TOLERANCING PER ANSI Y14.5M-1994.
 2. CONTROLLING DIMENSION: INCH.
 3. DIMENSION H IS MEASURED 0.030 (0.762) AWAY FROM PACKAGE BODY.
 4. RECOMMENDED BOLT CENTER DIMENSION OF 1.16 (29.57) BASED ON M3 SCREW.

DIM	INCHES		MILLIMETERS	
	MIN	MAX	MIN	MAX
A	1.335	1.345	33.91	34.16
B	0.535	0.545	13.6	13.8
C	0.147	0.200	3.73	5.08
D	0.495	0.505	12.57	12.83
E	0.035	0.045	0.89	1.14
F	0.003	0.006	0.08	0.15
G	1.100 BSC		27.94 BSC	
H	0.057	0.067	1.45	1.70
K	0.175	0.205	4.44	5.21
M	0.872	0.888	22.15	22.55
N	0.871	0.889	19.30	22.60
Q	\varnothing .118	\varnothing .138	\varnothing 3.00	\varnothing 3.51
R	0.515	0.525	13.10	13.30
S	0.515	0.525	13.10	13.30
aaa	0.007 REF		0.178 REF	
bbb	0.010 REF		0.254 REF	
ccc	0.015 REF		0.381 REF	

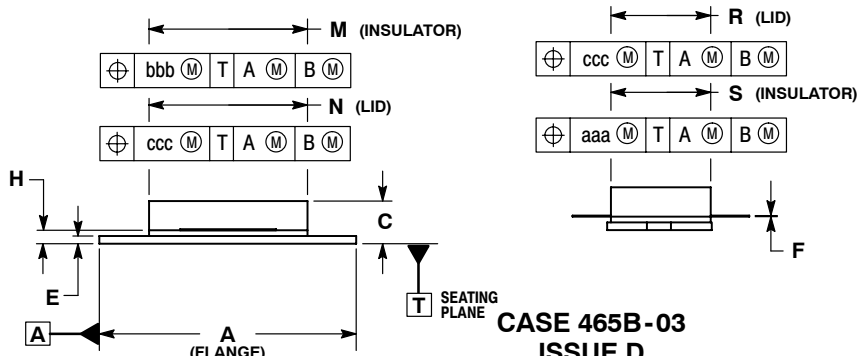

**CASE 465B-03
ISSUE D
NI-880
MRF21125R3**

- STYLE 1:
PIN 1. DRAIN
2. GATE
3. SOURCE

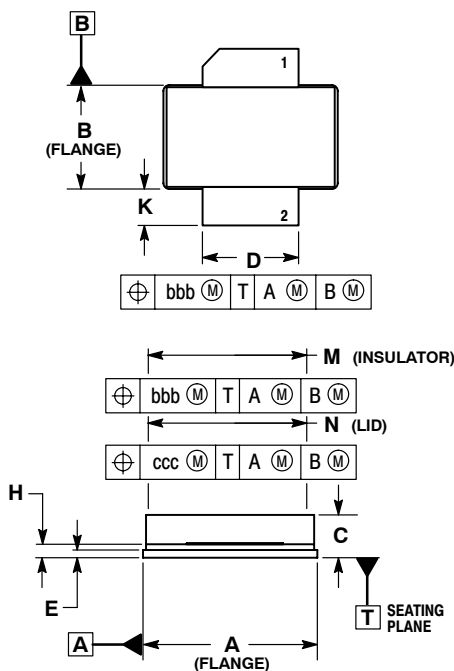

**CASE 465C-02
ISSUE D
NI-880S
MRF21125SR3**

- NOTES:
1. DIMENSIONING AND TOLERANCING PER ANSI Y14.5M-1994.
 2. CONTROLLING DIMENSION: INCH.
 3. DIMENSION H IS MEASURED 0.030 (0.762) AWAY FROM PACKAGE BODY.

DIM	INCHES		MILLIMETERS	
	MIN	MAX	MIN	MAX
A	0.905	0.915	22.99	23.24
B	0.535	0.545	13.60	13.80
C	0.147	0.200	3.73	5.08
D	0.495	0.505	12.57	12.83
E	0.035	0.045	0.89	1.14
F	0.003	0.006	0.08	0.15
H	0.057	0.067	1.45	1.70
K	0.170	0.210	4.32	5.33
M	0.872	0.888	22.15	22.55
N	0.871	0.889	19.30	22.60
R	0.515	0.525	13.10	13.30
S	0.515	0.525	13.10	13.30
aaa	0.007 REF		0.178 REF	
bbb	0.010 REF		0.254 REF	
ccc	0.015 REF		0.381 REF	

- STYLE 1:
PIN 1. DRAIN
2. GATE
3. SOURCE

ARCHIVE INFORMATION

ARCHIVE INFORMATION

How to Reach Us:

Home Page:
www.freescale.com

E-mail:
support@freescale.com

USA/Europe or Locations Not Listed:
Freescale Semiconductor
Technical Information Center, CH370
1300 N. Alma School Road
Chandler, Arizona 85224
+1-800-521-6274 or +1-480-768-2130
support@freescale.com

Europe, Middle East, and Africa:
Freescale Halbleiter Deutschland GmbH
Technical Information Center
Schatzbogen 7
81829 Muenchen, Germany
+44 1296 380 456 (English)
+46 8 52200080 (English)
+49 89 92103 559 (German)
+33 1 69 35 48 48 (French)
support@freescale.com

Japan:
Freescale Semiconductor Japan Ltd.
Headquarters
ARCO Tower 15F
1-8-1, Shimo-Meguro, Meguro-ku,
Tokyo 153-0064
Japan
0120 191014 or +81 3 5437 9125
support.japan@freescale.com

Asia/Pacific:
Freescale Semiconductor Hong Kong Ltd.
Technical Information Center
2 Dai King Street
Tai Po Industrial Estate
Tai Po, N.T., Hong Kong
+800 2666 8080
support.asia@freescale.com

For Literature Requests Only:
Freescale Semiconductor Literature Distribution Center
P.O. Box 5405
Denver, Colorado 80217
1-800-441-2447 or 303-675-2140
Fax: 303-675-2150
LDCForFreescaleSemiconductor@hibbertgroup.com

Information in this document is provided solely to enable system and software implementers to use Freescale Semiconductor products. There are no express or implied copyright licenses granted hereunder to design or fabricate any integrated circuits or integrated circuits based on the information in this document.

Freescale Semiconductor reserves the right to make changes without further notice to any products herein. Freescale Semiconductor makes no warranty, representation or guarantee regarding the suitability of its products for any particular purpose, nor does Freescale Semiconductor assume any liability arising out of the application or use of any product or circuit, and specifically disclaims any and all liability, including without limitation consequential or incidental damages. "Typical" parameters that may be provided in Freescale Semiconductor data sheets and/or specifications can and do vary in different applications and actual performance may vary over time. All operating parameters, including "Typicals", must be validated for each customer application by customer's technical experts. Freescale Semiconductor does not convey any license under its patent rights nor the rights of others. Freescale Semiconductor products are not designed, intended, or authorized for use as components in systems intended for surgical implant into the body, or other applications intended to support or sustain life, or for any other application in which the failure of the Freescale Semiconductor product could create a situation where personal injury or death may occur. Should Buyer purchase or use Freescale Semiconductor products for any such unintended or unauthorized application, Buyer shall indemnify and hold Freescale Semiconductor and its officers, employees, subsidiaries, affiliates, and distributors harmless against all claims, costs, damages, and expenses, and reasonable attorney fees arising out of, directly or indirectly, any claim of personal injury or death associated with such unintended or unauthorized use, even if such claim alleges that Freescale Semiconductor was negligent regarding the design or manufacture of the part.

Freescale™ and the Freescale logo are trademarks of Freescale Semiconductor, Inc. All other product or service names are the property of their respective owners.
© Freescale Semiconductor, Inc. 2006, 2009. All rights reserved.