

# LM285, LM385B

## Micropower Voltage Reference Diodes

The LM285/LM385 series are micropower two-terminal bandgap voltage regulator diodes. Designed to operate over a wide current range of 10  $\mu$ A to 20 mA, these devices feature exceptionally low dynamic impedance, low noise and stable operation over time and temperature. Tight voltage tolerances are achieved by on-chip trimming. The large dynamic operating range enables these devices to be used in applications with widely varying supplies with excellent regulation. Extremely low operating current make these devices ideal for micropower circuitry like portable instrumentation, regulators and other analog circuitry where extended battery life is required.

The LM285/LM385 series are packaged in a low cost TO-226 plastic case and are available in two voltage versions of 1.235 V and 2.500 V as denoted by the device suffix (see Ordering Information table). The LM285 is specified over a  $-40^{\circ}\text{C}$  to  $+85^{\circ}\text{C}$  temperature range while the LM385 is rated from  $0^{\circ}\text{C}$  to  $+70^{\circ}\text{C}$ .

The LM385 is also available in a surface mount plastic package in voltages of 1.235 V and 2.500 V.

### Features

- Operating Current from 10  $\mu$ A to 20 mA
- 1.0%, 1.5%, 2.0% and 3.0% Initial Tolerance Grades
- Low Temperature Coefficient
- 1.0  $\Omega$  Dynamic Impedance
- Surface Mount Package Available
- These Devices are Pb-Free and are RoHS Compliant

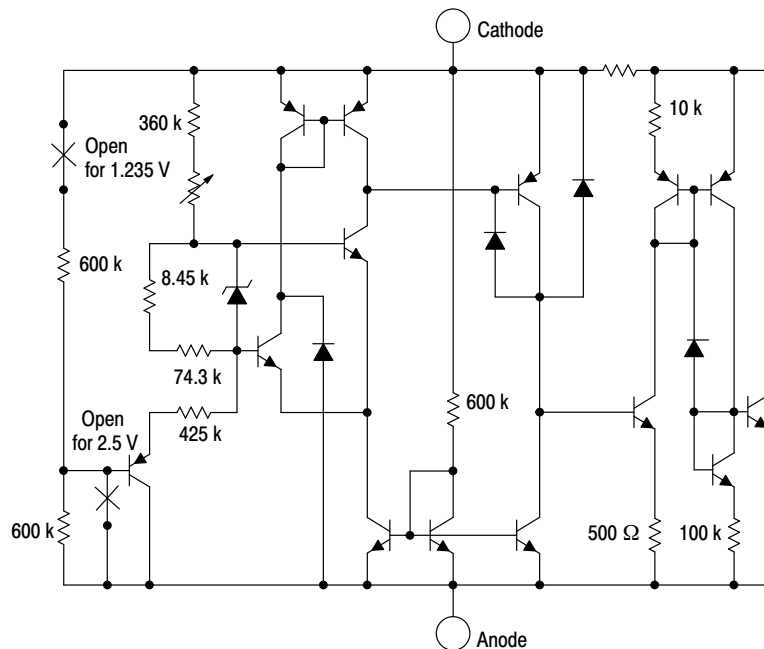

Figure 1. Representative Schematic Diagram



ON Semiconductor®

[www.onsemi.com](http://www.onsemi.com)

### MARKING DIAGRAMS



SOIC-8  
D SUFFIX  
CASE 751

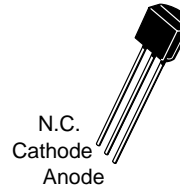
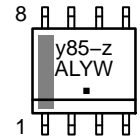

TO-92  
(TO-226)  
Z SUFFIX  
CASE 29

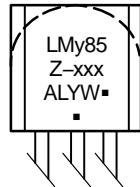

- xxx = 1.2 or 2.5
- y = 2 or 3
- z = 1 or 2
- A = Assembly Location
- L = Wafer Lot
- Y = Year
- W = Work Week
- = Pb-Free Package

(Note: Microdot may be in either location)

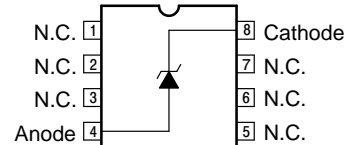
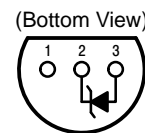

### Standard Application

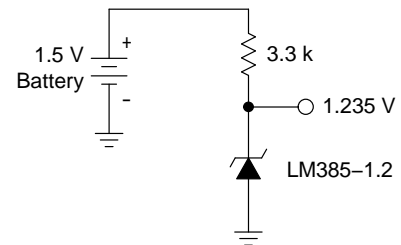

### ORDERING INFORMATION

See detailed ordering and shipping information in the package dimensions section on page 6 of this data sheet.

# LM285, LM385B

## MAXIMUM RATINGS (T<sub>A</sub> = 25°C, unless otherwise noted)

| Rating  | Symbol           | Value                  | Unit |
|---|------------------|------------------------|------|
| Reverse Current   | I <sub>R</sub>   | 30                     | mA   |
| Forward Current   | I <sub>F</sub>   | 10                     | mA   |
| Operating Ambient Temperature Range   | T <sub>A</sub>   | -40 to +85<br>0 to +70 | °C   |
| Operating Junction Temperature  | T <sub>J</sub>   | +150                   | °C   |
| Storage Temperature Range   | T <sub>stg</sub> | -65 to +150            | °C   |
| Electrostatic Discharge Sensitivity (ESD)<br>Human Body Model (HBM)<br>Machine Model (MM)<br>Charged Device Model (CDM) | ESD              | 4000<br>400<br>2000    | V    |

Stresses exceeding those listed in the Maximum Ratings table may damage the device. If any of these limits are exceeded, device functionality should not be assumed, damage may occur and reliability may be affected.

## ELECTRICAL CHARACTERISTICS (T<sub>A</sub> = 25°C, unless otherwise noted)

| Characteristic  | Symbol                  | LM285-1.2        |                  |                        | LM385-1.2/LM385B-1.2 |                  |                        | Unit    |
|---|-------------------------|------------------|------------------|------------------------|----------------------|------------------|------------------------|---------|
|   |                         | Min              | Typ              | Max                    | Min                  | Typ              | Max                    |         |
| Reverse Breakdown Voltage (I <sub>Rmin</sub> ≤ I <sub>R</sub> ≤ 20 mA)<br>LM285-1.2/LM385B-1.2<br>T <sub>A</sub> = T <sub>low</sub> to T <sub>high</sub> (Note 1)<br>LM385-1.2<br>T <sub>A</sub> = T <sub>low</sub> to T <sub>high</sub> (Note 1)   | V <sub>(BR)R</sub>      | 1.223<br>1.200   | 1.235<br>–       | 1.247<br>1.270         | 1.223<br>1.210       | 1.235<br>–       | 1.247<br>1.260         | V       |
| Minimum Operating Current<br>T <sub>A</sub> = 25°C<br>T <sub>A</sub> = T <sub>low</sub> to T <sub>high</sub> (Note 1)   | I <sub>Rmin</sub>       | –<br>–           | 8.0<br>–         | 10<br>20               | –<br>–               | 8.0<br>–         | 15<br>20               | μA      |
| Reverse Breakdown Voltage Change with Current<br>I <sub>Rmin</sub> ≤ I <sub>R</sub> ≤ 1.0 mA, T <sub>A</sub> = +25°C<br>T <sub>A</sub> = T <sub>low</sub> to T <sub>high</sub> (Note 1)<br>1.0 mA ≤ I <sub>R</sub> ≤ 20 mA, T <sub>A</sub> = +25°C<br>T <sub>A</sub> = T <sub>low</sub> to T <sub>high</sub> (Note 1) | ΔV <sub>(BR)R</sub>     | –<br>–<br>–<br>– | –<br>–<br>–<br>– | 1.0<br>1.5<br>10<br>20 | –<br>–<br>–<br>–     | –<br>–<br>–<br>– | 1.0<br>1.5<br>20<br>25 | mV      |
| Reverse Dynamic Impedance<br>I <sub>R</sub> = 100 μA, T <sub>A</sub> = +25°C  | Z                       | –                | 0.6              | –                      | –                    | 0.6              | –                      | Ω       |
| Average Temperature Coefficient<br>10 μA ≤ I <sub>R</sub> ≤ 20 mA, T <sub>A</sub> = T <sub>low</sub> to T <sub>high</sub> (Note 1)  | ΔV <sub>(BR)R</sub> /ΔT | –                | 80               | –                      | –                    | 80               | –                      | ppm/°C  |
| Wideband Noise (RMS)<br>I <sub>R</sub> = 100 μA, 10 Hz ≤ f ≤ 10 kHz   | n                       | –                | 60               | –                      | –                    | 60               | –                      | μV      |
| Long Term Stability<br>I <sub>R</sub> = 100 μA, T <sub>A</sub> = +25°C ± 0.1°C  | S                       | –                | 20               | –                      | –                    | 20               | –                      | ppm/kHR |
| Reverse Breakdown Voltage (I <sub>Rmin</sub> ≤ I <sub>R</sub> ≤ 20 mA)<br>LM285-2.5/LM385B-2.5<br>T <sub>A</sub> = T <sub>low</sub> to T <sub>high</sub> (Note 1)<br>LM385-2.5<br>T <sub>A</sub> = T <sub>low</sub> to T <sub>high</sub> (Note 1)   | V <sub>(BR)R</sub>      | 2.462<br>2.415   | 2.5<br>–         | 2.538<br>2.585         | 2.462<br>2.436       | 2.5<br>–         | 2.538<br>2.564         | V       |
| Minimum Operating Current<br>T <sub>A</sub> = 25°C<br>T <sub>A</sub> = T <sub>low</sub> to T <sub>high</sub> (Note 1)   | I <sub>Rmin</sub>       | –<br>–           | 13<br>–          | 20<br>30               | –<br>–               | 13<br>–          | 20<br>30               | μA      |

- T<sub>low</sub> = -40°C for LM285-1.2, LM285-2.5  
 T<sub>high</sub> = +85°C for LM285-1.2, LM285-2.5  
 T<sub>low</sub> = 0°C for LM385-1.2, LM385B-1.2, LM385-2.5, LM385B-2.5  
 T<sub>high</sub> = +70°C for LM385-1.2, LM385B-1.2, LM385-2.5, LM385B-2.5

## LM285, LM385B

### ELECTRICAL CHARACTERISTICS ( $T_A = 25^\circ\text{C}$ , unless otherwise noted)

| Characteristic   | Symbol                     | LM285-1.2 |     |     | LM385-1.2/LM385B-1.2 |     |     | Unit                  |
|--|----------------------------|-----------|-----|-----|----------------------|-----|-----|-----------------------|
|  |                            | Min       | Typ | Max | Min                  | Typ | Max |                       |
| Reverse Breakdown Voltage Change with Current<br>$I_{Rmin} \leq I_R \leq 1.0 \text{ mA}$ , $T_A = +25^\circ\text{C}$<br>$T_A = T_{low}$ to $T_{high}$ (Note 2)<br>$1.0 \text{ mA} \leq I_R \leq 20 \text{ mA}$ , $T_A = +25^\circ\text{C}$<br>$T_A = T_{low}$ to $T_{high}$ (Note 2) | $\Delta V_{(BR)R}$         | -         | -   | 1.0 | -                    | -   | 2.0 | mV                    |
| Reverse Dynamic Impedance<br>$I_R = 100 \mu\text{A}$ , $T_A = +25^\circ\text{C}$   | Z                          | -         | 0.6 | -   | -                    | 0.6 | -   | $\Omega$              |
| Average Temperature Coefficient<br>$20 \mu\text{A} \leq I_R \leq 20 \text{ mA}$ , $T_A = T_{low}$ to $T_{high}$ (Note 2)   | $\Delta V_{(BR)}/\Delta T$ | -         | 80  | -   | -                    | 80  | -   | ppm/ $^\circ\text{C}$ |
| Wideband Noise (RMS)<br>$I_R = 100 \mu\text{A}$ , $10 \text{ Hz} \leq f \leq 10 \text{ kHz}$   | n                          | -         | 120 | -   | -                    | 120 | -   | $\mu\text{V}$         |
| Long Term Stability<br>$I_R = 100 \mu\text{A}$ , $T_A = +25^\circ\text{C} \pm 0.1^\circ\text{C}$   | S                          | -         | 20  | -   | -                    | 20  | -   | ppm/kHR               |

2.  $T_{low} = -40^\circ\text{C}$  for LM285-1.2, LM285-2.5  
 $T_{high} = +85^\circ\text{C}$  for LM285-1.2, LM285-2.5  
 $T_{low} = 0^\circ\text{C}$  for LM385-1.2, LM385B-1.2, LM385-2.5, LM385B-2.5  
 $T_{high} = +70^\circ\text{C}$  for LM385-1.2, LM385B-1.2, LM385-2.5, LM385B-2.5

# LM285, LM385B

## TYPICAL PERFORMANCE CURVES FOR LM285-1.2/385-1.2/385B-1.2

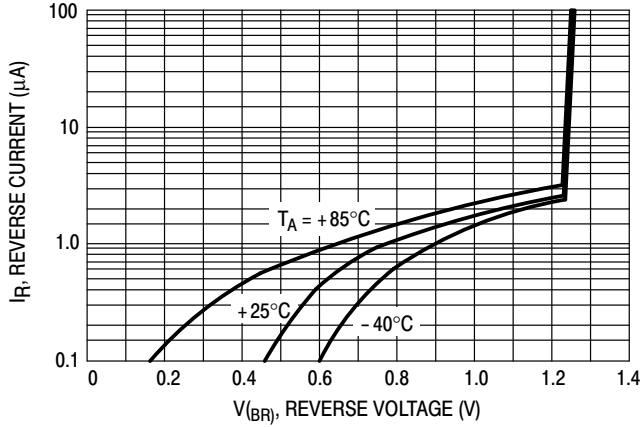

Figure 2. Reverse Characteristics

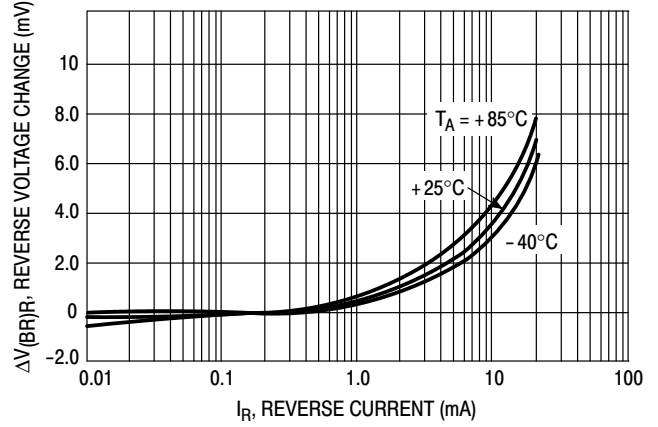

Figure 3. Reverse Characteristics

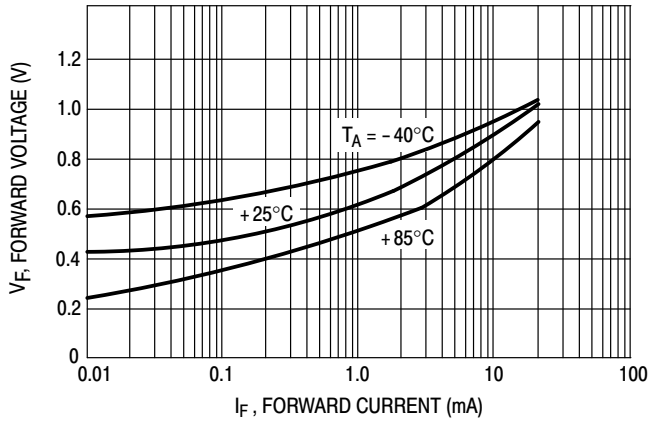

Figure 4. Forward Characteristics

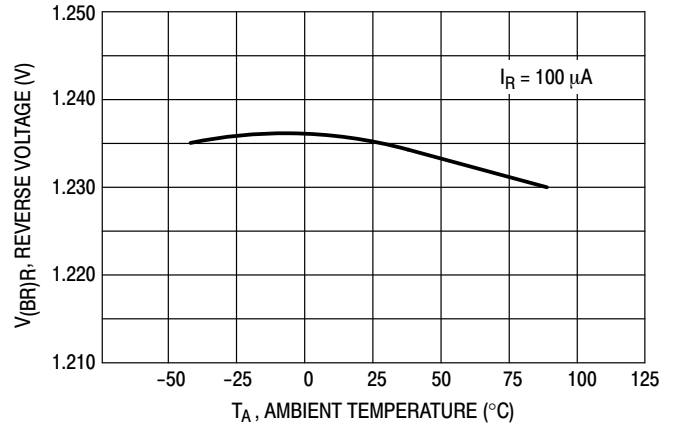

Figure 5. Temperature Drift

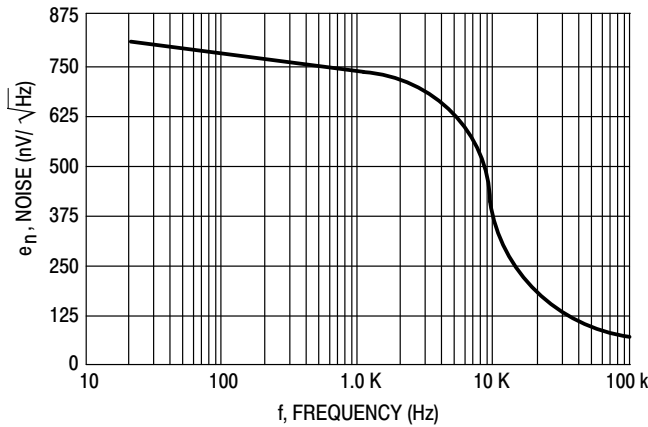

Figure 6. Noise Voltage

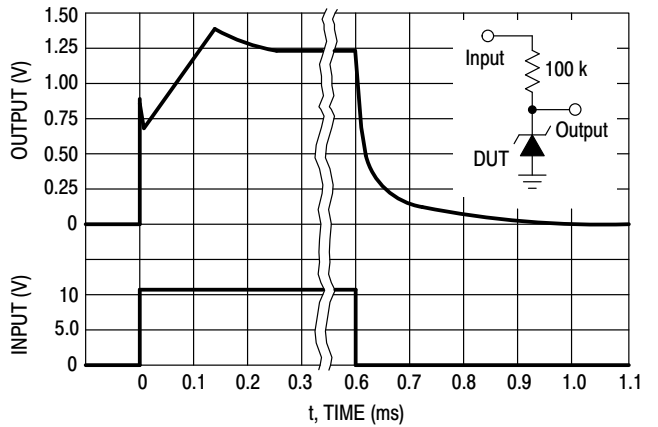

Figure 7. Response Time

# LM285, LM385B

## TYPICAL PERFORMANCE CURVES FOR LM285-2.5/385-2.5/385B-2.5

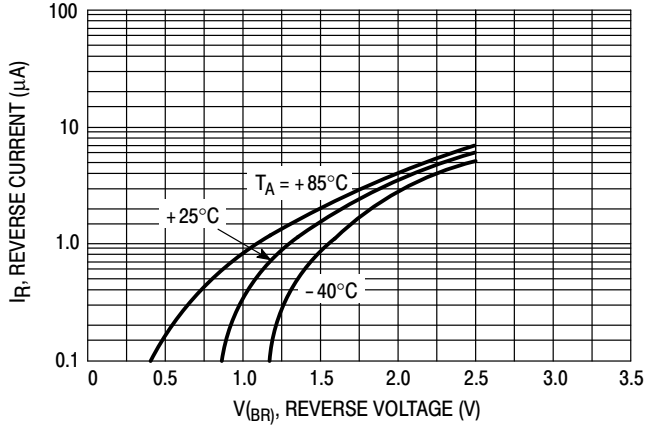

Figure 8. Reverse Characteristics

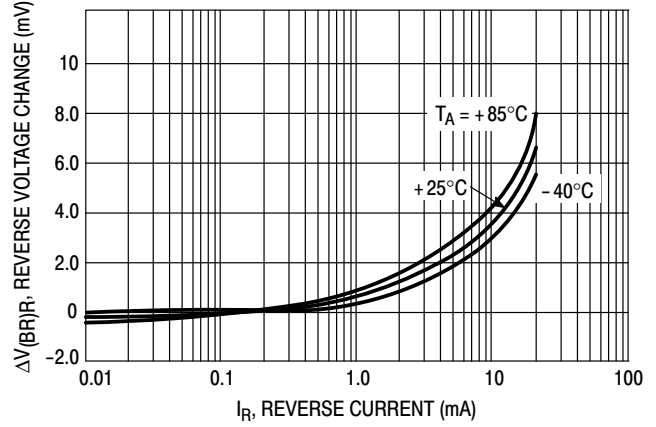

Figure 9. Reverse Characteristics

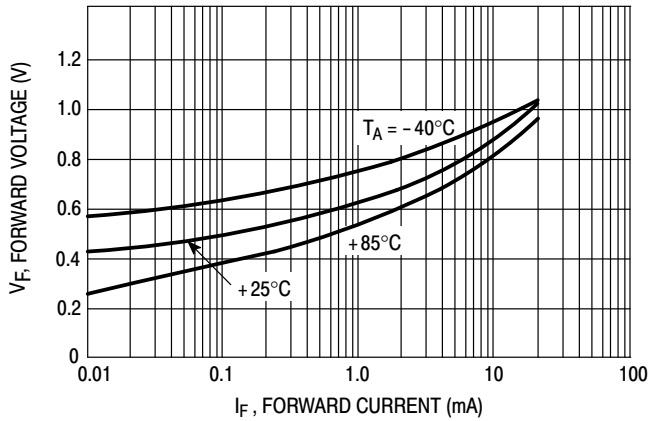

Figure 10. Forward Characteristics

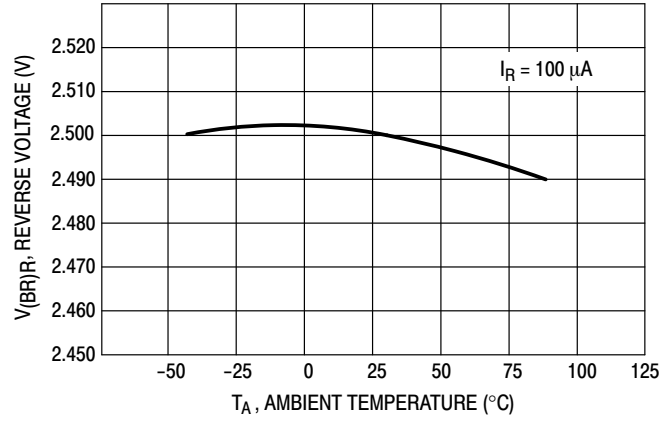

Figure 11. Temperature Drift

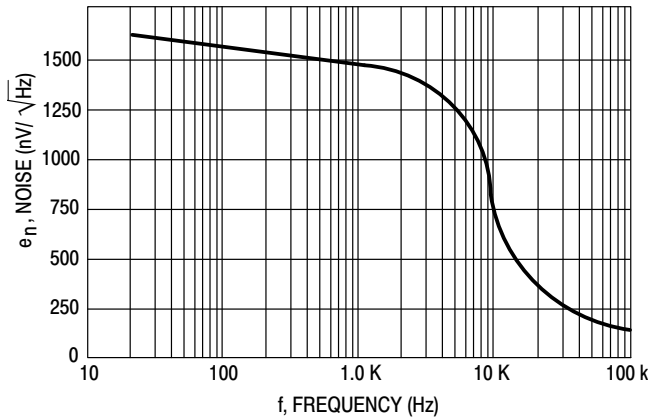

Figure 12. Noise Voltage

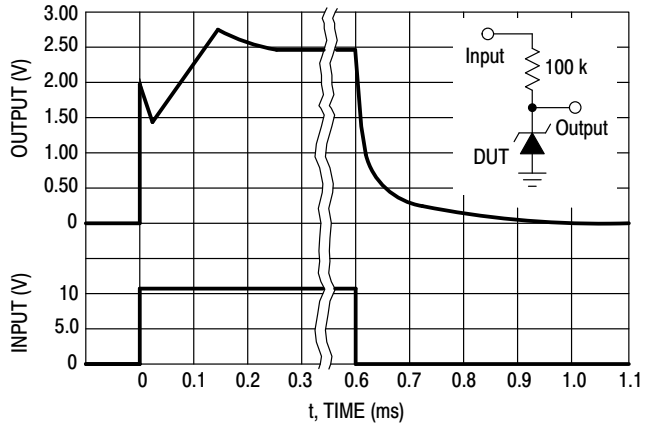

Figure 13. Response Time

# LM285, LM385B

## ORDERING INFORMATION

| Device         | Operating Temperature Range     | Reverse Break-Down Voltage      | Package          | Shipping†             |                    |
|----------------|---------------------------------|---------------------------------|------------------|-----------------------|--------------------|
| LM285D-1.2     | T <sub>A</sub> = -40°C to +85°C | 1.235 V                         | SOIC-8           | 98 Units / Rail       |                    |
| LM285D-1.2G    |                                 |                                 | SOIC-8 (Pb-Free) | 98 Units / Rail       |                    |
| LM285D-1.2R2   |                                 |                                 | SOIC-8           | 2500 / Tape & Reel    |                    |
| LM285D-1.2R2G  |                                 |                                 | SOIC-8 (Pb-Free) | 2500 / Tape & Reel    |                    |
| LM285D-2.5     |                                 | 2.500 V                         | SOIC-8           | 98 Units / Rail       |                    |
| LM285D-2.5G    |                                 |                                 | SOIC-8 (Pb-Free) | 98 Units / Rail       |                    |
| LM285D-2.5R2   |                                 |                                 | SOIC-8           | 2500 / Tape & Reel    |                    |
| LM285D-2.5R2G  |                                 |                                 | SOIC-8 (Pb-Free) | 2500 / Tape & Reel    |                    |
| LM285Z-1.2     |                                 | T <sub>A</sub> = -40°C to +85°C | 1.235 V          | TO-92                 | 2000 Units / Bag   |
| LM285Z-1.2G    |                                 |                                 |                  | TO-92 (Pb-Free)       | 2000 Units / Bag   |
| LM285Z-2.5     |                                 |                                 | 2.500 V          | TO-92                 | 2000 Units / Bag   |
| LM285Z-2.5G    |                                 |                                 |                  | TO-92 (Pb-Free)       | 2000 Units / Bag   |
| LM285Z-1.2RA   |                                 |                                 | 1.235 V          | TO-92                 | 2000 / Tape & Reel |
| LM285Z-1.2RAG  |                                 |                                 |                  | TO-92 (Pb-Free)       | 2000 / Tape & Reel |
| LM285Z-2.5RA   |                                 |                                 | 2.500 V          | TO-92                 | 2000 / Tape & Reel |
| LM285Z-2.5RAG  |                                 |                                 |                  | TO-92 (Pb-Free)       | 2000 / Tape & Reel |
| LM285Z-2.5RP   | TO-92                           |                                 |                  | 2000 Units / Fan-Fold |                    |
| LM285Z-2.5RPG  | TO-92 (Pb-Free)                 |                                 |                  | 2000 Units / Fan-Fold |                    |
| LM385BD-1.2    | T <sub>A</sub> = 0°C to +70°C   |                                 | 1.235 V          | SOIC-8                | 98 Units / Rail    |
| LM385BD-1.2G   |                                 |                                 |                  | SOIC-8 (Pb-Free)      | 98 Units / Rail    |
| LM385BD-1.2R2  |                                 |                                 |                  | SOIC-8                | 2500 / Tape & Reel |
| LM385BD-1.2R2G |                                 |                                 |                  | SOIC-8 (Pb-Free)      | 2500 / Tape & Reel |
| LM385BD-2.5    |                                 |                                 | 2.500 V          | SOIC-8                | 98 Units / Rail    |
| LM385BD-2.5G   |                                 |                                 |                  | SOIC-8 (Pb-Free)      | 98 Units / Rail    |
| LM385BD-2.5R2  |                                 | SOIC-8                          |                  | 2500 / Tape & Reel    |                    |
| LM385BD-2.5R2G |                                 | SOIC-8 (Pb-Free)                |                  | 2500 / Tape & Reel    |                    |
| LM385BZ-1.2    |                                 | 1.235 V                         | TO-92            | 2000 Units / Bag      |                    |
| LM385BZ-1.2G   |                                 |                                 | TO-92 (Pb-Free)  | 2000 Units / Bag      |                    |
| LM385BZ-1.2RA  |                                 |                                 | TO-92            | 2000 / Tape & Reel    |                    |
| LM385BZ-1.2RAG |                                 |                                 | TO-92 (Pb-Free)  | 2000 / Tape & Reel    |                    |

†For information on tape and reel specifications, including part orientation and tape sizes, please refer to our Tape and Reel Packaging Specifications Brochure, BRD8011/D.

# LM285, LM385B

## ORDERING INFORMATION

| Device         | Operating Temperature Range                        | Reverse Break-Down Voltage | Package         | Shipping†          |                    |                 |                  |
|----------------|--|----------------------------|-----------------|--------------------|--------------------|-----------------|------------------|
| LM385BZ-2.5    | $T_A = 0^{\circ}\text{C}$ to $+70^{\circ}\text{C}$ | 2.500 V                    | TO-92           | 2000 Units / Bag   |                    |                 |                  |
| LM385BZ-2.5G   |  |                            | TO-92 (Pb-Free) | 2000 Units / Bag   |                    |                 |                  |
| LM385BZ-2.5RA  |  |                            | TO-92           | 2000 / Tape & Reel |                    |                 |                  |
| LM385BZ-2.5RAG |  |                            | TO-92 (Pb-Free) | 2000 / Tape & Reel |                    |                 |                  |
| LM385D-1.2     |  | 1.235 V                    | 1.235 V         | SOIC-8             | 98 Units / Rail    |                 |                  |
| LM385D-1.2G    |  |                            |                 | SOIC-8 (Pb-Free)   | 98 Units / Rail    |                 |                  |
| LM385D-1.2R2   |  |                            |                 | SOIC-8             | 2500 / Tape & Reel |                 |                  |
| LM385D-1.2R2G  |  |                            |                 | SOIC-8 (Pb-Free)   | 2500 / Tape & Reel |                 |                  |
| LM385D-2.5     |  | 2.500 V                    | 2.500 V         | SOIC-8             | 98 Units / Rail    |                 |                  |
| LM385D-2.5G    |  |                            |                 | SOIC-8 (Pb-Free)   | 98 Units / Rail    |                 |                  |
| LM385D-2.5R2   |  |                            |                 | SOIC-8             | 2500 / Tape & Reel |                 |                  |
| LM385D-2.5R2G  |  |                            |                 | SOIC-8 (Pb-Free)   | 2500 / Tape & Reel |                 |                  |
| LM385Z-1.2     |  | 1.235 V                    | 1.235 V         | TO-92              | 2000 Units / Bag   |                 |                  |
| LM385Z-1.2G    |  |                            |                 | TO-92 (Pb-Free)    | 2000 Units / Bag   |                 |                  |
| LM385Z-1.2RA   |  |                            |                 | TO-92              | 2000 / Tape & Reel |                 |                  |
| LM385Z-1.2RAG  |  |                            |                 | TO-92 (Pb-Free)    | 2000 / Tape & Reel |                 |                  |
| LM385Z-1.2RP   |  |                            |                 | TO-92              | 2000 / Ammo Box    |                 |                  |
| LM385Z-1.2RPG  |  |                            |                 | TO-92 (Pb-Free)    | 2000 / Ammo Box    |                 |                  |
| LM385Z-2.5     |  |                            |                 | 2.500 V            | 2.500 V            | TO-92           | 2000 Units / Bag |
| LM385Z-2.5G    |  |                            |                 |                    |                    | TO-92 (Pb-Free) | 2000 Units / Bag |
| LM385Z-2.5RP   | TO-92  | 2000 / Ammo Box            |                 |                    |                    |                 |                  |
| LM385Z-2.5RPG  | TO-92 (Pb-Free)                                    | 2000 / Ammo Box            |                 |                    |                    |                 |                  |

†For information on tape and reel specifications, including part orientation and tape sizes, please refer to our Tape and Reel Packaging Specifications Brochure, BRD8011/D.

# LM285, LM385B

## PACKAGE DIMENSIONS

TO-92 (TO-226)  
CASE 29-11  
ISSUE AM

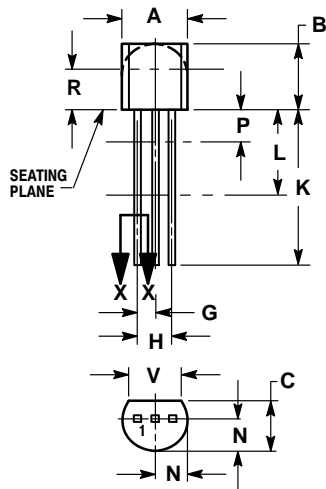

STRAIGHT LEAD  
BULK PACK

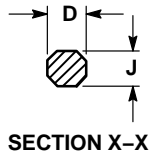

NOTES:

1. DIMENSIONING AND TOLERANCING PER ANSI Y14.5M, 1982.
2. CONTROLLING DIMENSION: INCH.
3. CONTOUR OF PACKAGE BEYOND DIMENSION R IS UNCONTROLLED.
4. LEAD DIMENSION IS UNCONTROLLED IN P AND BEYOND DIMENSION K MINIMUM.

| DIM | INCHES |       | MILLIMETERS |       |
|-----|--------|-------|-------------|-------|
|     | MIN    | MAX   | MIN         | MAX   |
| A   | 0.175  | 0.205 | 4.45        | 5.20  |
| B   | 0.170  | 0.210 | 4.32        | 5.33  |
| C   | 0.125  | 0.165 | 3.18        | 4.19  |
| D   | 0.016  | 0.021 | 0.407       | 0.533 |
| G   | 0.045  | 0.055 | 1.15        | 1.39  |
| H   | 0.095  | 0.105 | 2.42        | 2.66  |
| J   | 0.015  | 0.020 | 0.39        | 0.50  |
| K   | 0.500  | ---   | 12.70       | ---   |
| L   | 0.250  | ---   | 6.35        | ---   |
| N   | 0.080  | 0.105 | 2.04        | 2.66  |
| P   | ---    | 0.100 | ---         | 2.54  |
| R   | 0.115  | ---   | 2.93        | ---   |
| V   | 0.135  | ---   | 3.43        | ---   |

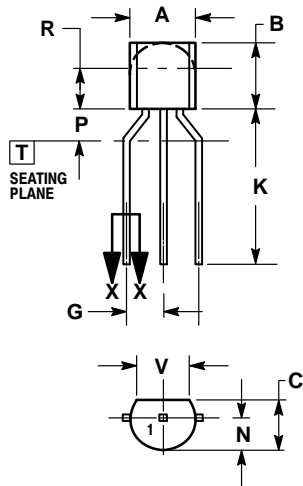

BENT LEAD  
TAPE & REEL  
AMMO PACK

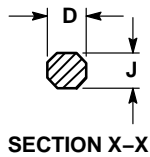

NOTES:

1. DIMENSIONING AND TOLERANCING PER ASME Y14.5M, 1994.
2. CONTROLLING DIMENSION: MILLIMETERS.
3. CONTOUR OF PACKAGE BEYOND DIMENSION R IS UNCONTROLLED.
4. LEAD DIMENSION IS UNCONTROLLED IN P AND BEYOND DIMENSION K MINIMUM.

| DIM | MILLIMETERS |      |
|-----|-------------|------|
|     | MIN         | MAX  |
| A   | 4.45        | 5.20 |
| B   | 4.32        | 5.33 |
| C   | 3.18        | 4.19 |
| D   | 0.40        | 0.54 |
| G   | 2.40        | 2.80 |
| J   | 0.39        | 0.50 |
| K   | 12.70       | ---  |
| N   | 2.04        | 2.66 |
| P   | 1.50        | 4.00 |
| R   | 2.93        | ---  |
| V   | 3.43        | ---  |



# LM285, LM385B

## PACKAGE DIMENSIONS

SOIC-8 NB  
CASE 751-07  
ISSUE AK

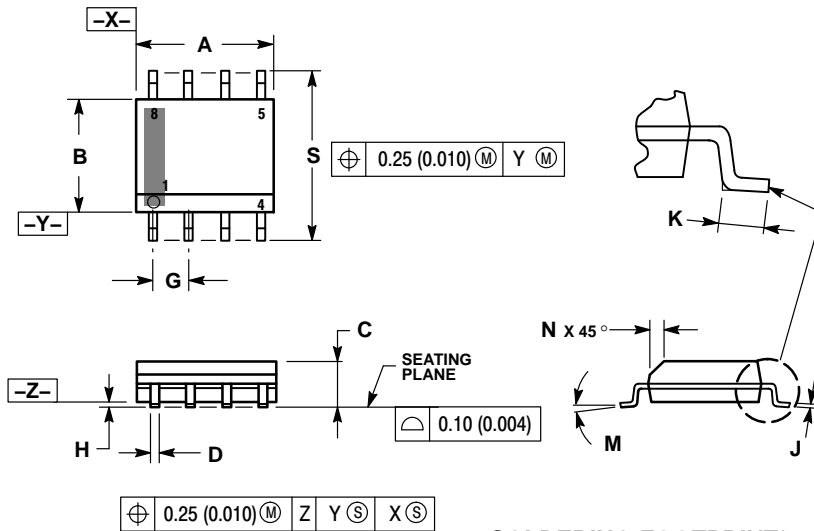

**NOTES:**

1. DIMENSIONING AND TOLERANCING PER ANSI Y14.5M, 1982.
2. CONTROLLING DIMENSION: MILLIMETER.
3. DIMENSION A AND B DO NOT INCLUDE MOLD PROTRUSION.
4. MAXIMUM MOLD PROTRUSION 0.15 (0.006) PER SIDE.
5. DIMENSION D DOES NOT INCLUDE DAMBAR PROTRUSION. ALLOWABLE DAMBAR PROTRUSION SHALL BE 0.127 (0.005) TOTAL IN EXCESS OF THE D DIMENSION AT MAXIMUM MATERIAL CONDITION.
6. 751-01 THRU 751-06 ARE OBSOLETE. NEW STANDARD IS 751-07.

| DIM | MILLIMETERS |      | INCHES    |       |
|-----|-------------|------|-----------|-------|
|     | MIN         | MAX  | MIN       | MAX   |
| A   | 4.80        | 5.00 | 0.189     | 0.197 |
| B   | 3.80        | 4.00 | 0.150     | 0.157 |
| C   | 1.35        | 1.75 | 0.053     | 0.069 |
| D   | 0.33        | 0.51 | 0.013     | 0.020 |
| G   | 1.27 BSC    |      | 0.050 BSC |       |
| H   | 0.10        | 0.25 | 0.004     | 0.010 |
| J   | 0.19        | 0.25 | 0.007     | 0.010 |
| K   | 0.40        | 1.27 | 0.016     | 0.050 |
| M   | 0°          | 8°   | 0°        | 8°    |
| N   | 0.25        | 0.50 | 0.010     | 0.020 |
| S   | 5.80        | 6.20 | 0.228     | 0.244 |

### SOLDERING FOOTPRINT\*

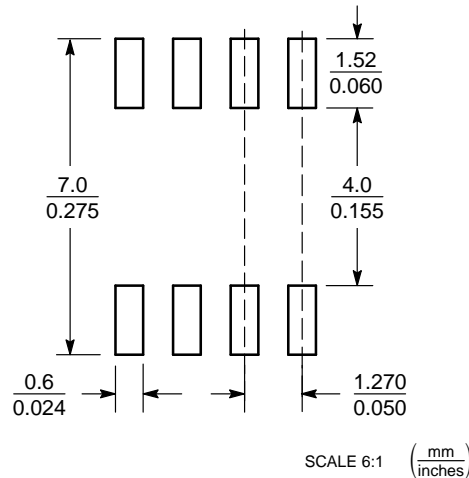

\*For additional information on our Pb-Free strategy and soldering details, please download the ON Semiconductor Soldering and Mounting Techniques Reference Manual, SOLDERRM/D.

ON Semiconductor and are trademarks of Semiconductor Components Industries, LLC dba ON Semiconductor or its subsidiaries in the United States and/or other countries. ON Semiconductor owns the rights to a number of patents, trademarks, copyrights, trade secrets, and other intellectual property. A listing of ON Semiconductor's product/patent coverage may be accessed at [www.onsemi.com/site/pdf/Patent-Marking.pdf](http://www.onsemi.com/site/pdf/Patent-Marking.pdf). ON Semiconductor reserves the right to make changes without further notice to any products herein. ON Semiconductor makes no warranty, representation or guarantee regarding the suitability of its products for any particular purpose, nor does ON Semiconductor assume any liability arising out of the application or use of any product or circuit, and specifically disclaims any and all liability, including without limitation special, consequential or incidental damages. Buyer is responsible for its products and applications using ON Semiconductor products, including compliance with all laws, regulations and safety requirements or standards, regardless of any support or applications information provided by ON Semiconductor. "Typical" parameters which may be provided in ON Semiconductor data sheets and/or specifications can and do vary in different applications and actual performance may vary over time. All operating parameters, including "Typicals" must be validated for each customer application by customer's technical experts. ON Semiconductor does not convey any license under its patent rights nor the rights of others. ON Semiconductor products are not designed, intended, or authorized for use as a critical component in life support systems or any FDA Class 3 medical devices or medical devices with a same or similar classification in a foreign jurisdiction or any devices intended for implantation in the human body. Should Buyer purchase or use ON Semiconductor products for any such unintended or unauthorized application, Buyer shall indemnify and hold ON Semiconductor and its officers, employees, subsidiaries, affiliates, and distributors harmless against all claims, costs, damages, and expenses, and reasonable attorney fees arising out of, directly or indirectly, any claim of personal injury or death associated with such unintended or unauthorized use, even if such claim alleges that ON Semiconductor was negligent regarding the design or manufacture of the part. ON Semiconductor is an Equal Opportunity/Affirmative Action Employer. This literature is subject to all applicable copyright laws and is not for resale in any manner.

### PUBLICATION ORDERING INFORMATION

**LITERATURE FULFILLMENT:**  
Literature Distribution Center for ON Semiconductor  
19521 E. 32nd Pkwy, Aurora, Colorado 80011 USA  
**Phone:** 303-675-2175 or 800-344-3860 Toll Free USA/Canada  
**Fax:** 303-675-2176 or 800-344-3867 Toll Free USA/Canada  
**Email:** [orderlit@onsemi.com](mailto:orderlit@onsemi.com)

**N. American Technical Support:** 800-282-9855 Toll Free  
USA/Canada  
**Europe, Middle East and Africa Technical Support:**  
Phone: 421 33 790 2910  
**Japan Customer Focus Center**  
Phone: 81-3-5817-1050

**ON Semiconductor Website:** [www.onsemi.com](http://www.onsemi.com)  
**Order Literature:** <http://www.onsemi.com/orderlit>

For additional information, please contact your local Sales Representative