

NUMBER C-175151



METRIC

単位: mm DIMENSIONS IN MM. DO NOT SCALE PRINT

PRINT DIST

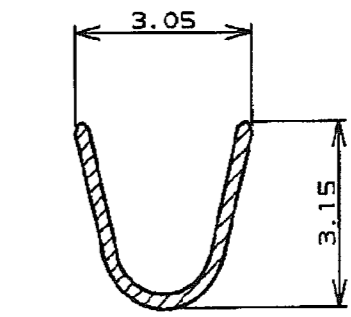
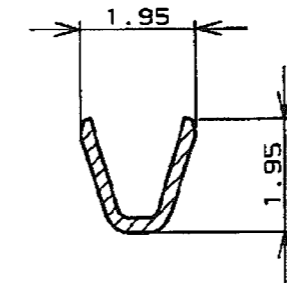
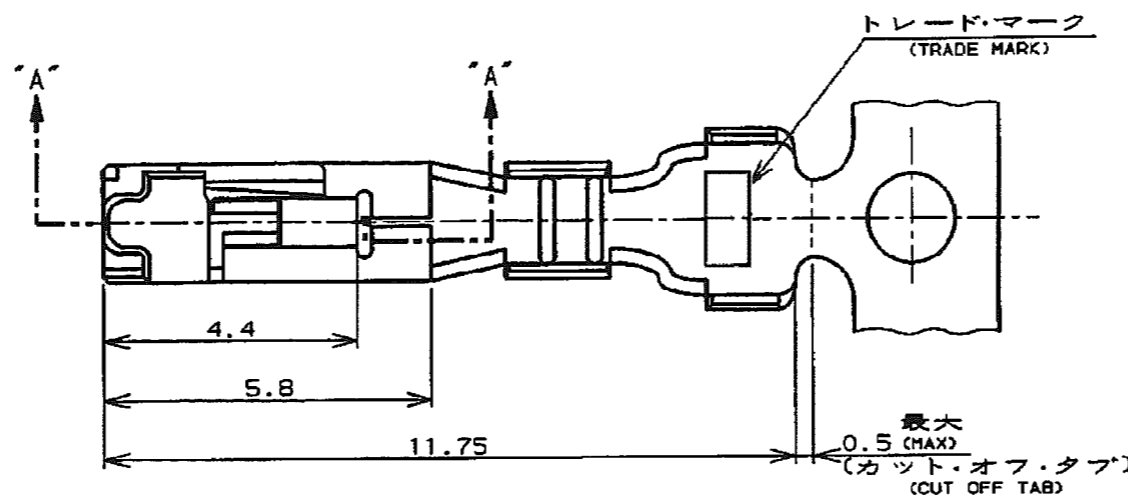

断面 "D"- "D"
(SECT)

断面 "E"- "E"
(SECT)

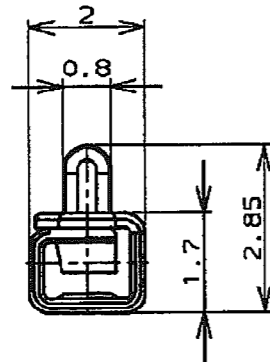

断面 "B"- "B"
(SECT)

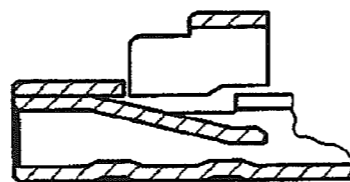
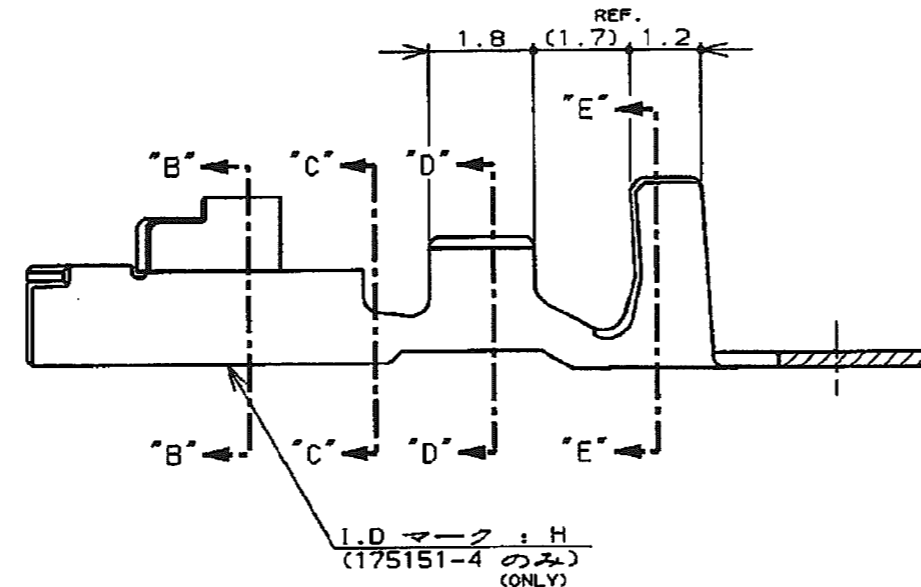

断面 "A"- "A"
(SECT) (175151-1, -2)

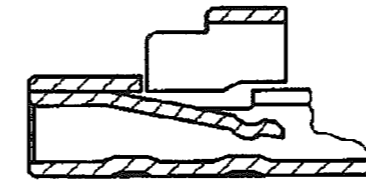

断面 "A"- "A"
(SECT) (175151-4)

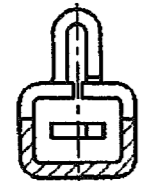

断面 "C"- "C"
(SECT)

- 注記:
- 適用規格
 - 製品規格 : 108-5302
 - 取付適用規格 : 114-5142
 - 取扱説明書 : IS-503J

- NOTES:
- APPLICABLE SPEC
 - PRODUCT SPEC : 108-5302
 - APPLICATION SPEC : 114-5142
 - INSTRUTION SHEET : IS-503J

	NYE: 502H-20-UV 1L7"カトオ化処理 (APPLIED LUBRICANT OIL)	錫めつき黄銅 (PRE TINNED BRASS)	175151-5
175155-4	---	錫めつき黄銅合金 (PRE TINNED COPPER ALLOY)	175151-4
175155-2	---	錫めつき黄銅 (PRE TINNED BRASS)	175151-2
175155-1	---	錫めつき黄銅合金 (PRE TINNED COPPER ALLOY)	175151-1
バラ状端子型番 (L.P P/N)	仕上 (FINISH)	材料 (MATERIAL)	型番 (P/N)

F1	REVISED PER ECO-11-005030	RK	HMR	01APR11	DR.	8. JUN '95	DE.	8. JUN '95
LTR	変更 (REVISION RECORD)	DR	CHK	DATE	CHK.	8. JUN '95	APP.	8. JUN '95
					N. NAGASHIMA		M. SHINDO	
					M. SHINDO		Y. KASHIWA	

適合電線断面積 (WIRE RANGE) 0.12~0.35mm ² (AWG#26~22)	被覆外径 (INSULATION DIA.) 1.2~2 mmφ	名称 (NAME) リセクタクル・コンタクト、アンプ・ユニバーサル・パワー・コネクタ (REC CONTACT AMP UNIVERSAL POWER CONN.)										
材料 (MATERIAL) 表参照 (SEE TABLE)	仕上 (FINISH) 表参照 (SEE TABLE)	一般公差 (GENERAL TOLERANCE) 10以下: ±0.2 10~30以下: ±0.25 30~100以下: ±0.3 角 度: ±3°										
<table border="1" style="width: 100%;"> <tr> <td>LOC</td> <td>番号 (No.)</td> </tr> <tr> <td>B J</td> <td>C-175151</td> </tr> </table>		LOC	番号 (No.)	B J	C-175151	<table border="1" style="width: 100%;"> <tr> <td>尺度 (SCALE)</td> <td>REV.</td> <td>SHEET</td> </tr> <tr> <td>---</td> <td>F1</td> <td>1 OF 1</td> </tr> </table>	尺度 (SCALE)	REV.	SHEET	---	F1	1 OF 1
LOC	番号 (No.)											
B J	C-175151											
尺度 (SCALE)	REV.	SHEET										
---	F1	1 OF 1										