

XS218SANAL2

Inductive proximity sensors XS, inductive sensor XS2 M18, L60mm, stainless, Sn12mm, 12...24 VDC, cable 2 m



Main

Range of Product	Telemecanique Inductive proximity sensors XS
Series name	Application
Sensor Type	Inductive proximity sensor
Device Application	Food and beverage
Market Segment	Pharmaceutical
Sensor name	XS2
Sensor design	Cylindrical M18
Size	60 mm
Body type	Fixed
Detector flush mounting acceptance	Non flush mountable
Material	Stainless steel
Type of output signal	Discrete
Wiring Technique	3-wire
[Sn] nominal sensing distance	0.47 in (12 mm)
Discrete output function	1 NO
Output circuit type	DC
Discrete output type	NPN
Electrical connection	Cable
Cable length	6.56 ft (2 m)
[Us] rated supply voltage	12...24 V DC reverse polarity protection
Switching capacity in mA	<= 200 mA overload and short-circuit protection
IP degree of protection	IP68 double insulation conforming to IEC 60529 IP69K conforming to DIN 40050

Complementary

Thread type	M18 x 1
Detection face	Frontal
Front material	PPS
Enclosure Material	Stainless steel 316 L
Sensing range	> 0.31...0.59 in (> 8...15 mm)
Operating zone	0.00...0.38 in (0...9.6 mm)
Differential travel	1...15% of Sr
Cable composition	3 x 0.34 mm ²
Wire insulation material	PVC
Status LED	Output state 1 LED yellow)
Supply voltage limits	10...36 V DC
Switching frequency	<= 1000 Hz
Maximum voltage drop	<2 V closed)
Current consumption	<= 10 mA no-load
Maximum delay first up	10 ms
Maximum delay response	0.3 ms
Maximum delay recovery	0.7 ms

Marking	CE
Threaded length	1.57 in (40 mm)
Length	2.36 in (60 mm)
Net Weight	0.26 lb(US) (0.12 kg)

Environment

Product Certifications	UL CSA
Ambient Air Temperature for Operation	-13...185 °F (-25...85 °C)
Ambient Air Temperature for Storage	-40...185 °F (-40...85 °C)
Vibration resistance	25 gn +/- 2 mm 10...55 Hz)IEC 60068-2-6
Shock resistance	50 gn 11 ms IEC 60068-2-27





Ordering and shipping details

Category	22486-SENSORS, PROXIMITY
Discount Schedule	DS2
GTIN	3389119113267
Nbr. of units in pkg.	1
Package weight(Lbs)	4.27 oz (121.0 g)
Returnability	No
Country of origin	FR

Packing Units

Unit Type of Package 1	PCE
Package 1 Height	1.65 in (4.2 cm)
Package 1 width	3.74 in (9.5 cm)
Package 1 Length	5.12 in (13 cm)
Unit Type of Package 2	S01
Number of Units in Package 2	11
Package 2 Weight	3.41 lb(US) (1.549 kg)
Package 2 Height	5.91 in (15 cm)
Package 2 width	5.91 in (15 cm)
Package 2 Length	15.75 in (40 cm)
Package 3 Height	5.91 in (15 cm)

Offer Sustainability

Sustainable offer status	Green Premium product
California proposition 65	WARNING: This product can expose you to chemicals including: Diisononyl phthalate (DINP), which is known to the State of California to cause cancer, and Di-isodecyl phthalate (DIDP), which is known to the State of California to cause birth defects or other reproductive harm. For more information go to www.P65Warnings.ca.gov
REACH Regulation	 REACH Declaration
EU RoHS Directive	Pro-active compliance (Product out of EU RoHS legal scope)  EU RoHS Declaration
Mercury free	Yes
RoHS exemption information	 Yes
Environmental Disclosure	 Product Environmental Profile
Circularity Profile	 End Of Life Information

Contractual warranty

Warranty	18 months
----------	-----------

Dimensions

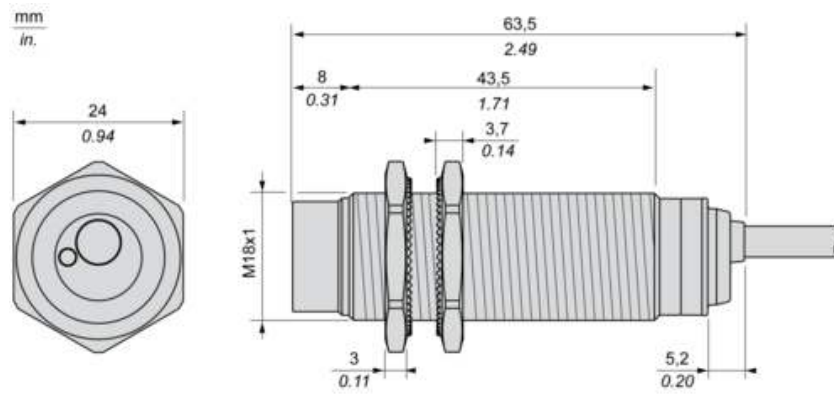

Minimum Mounting Distances

Side by side

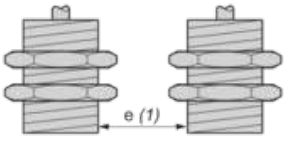

$e (1) \geq 72 \text{ mm}/2.83 \text{ in.}$

Face to face

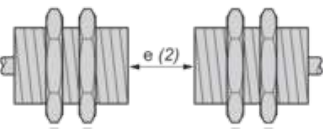

$e (2) \geq 144 \text{ mm}/5.67 \text{ in.}$

Facing a metal object

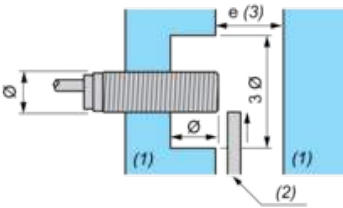

$e (3) \geq 36 \text{ mm}/1.42 \text{ in}$

(1) Metal

(2) Object to be detected

Mounting

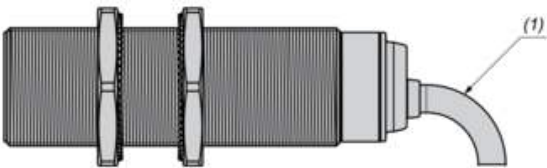

(1) Bending cable: 4 x external cable diameter

Wiring Schemes

NPN

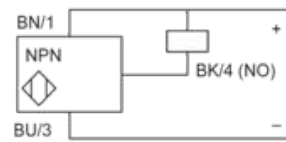

BU : Blue

BN : Brown

BK : Black