

SITCore Single Board Computers

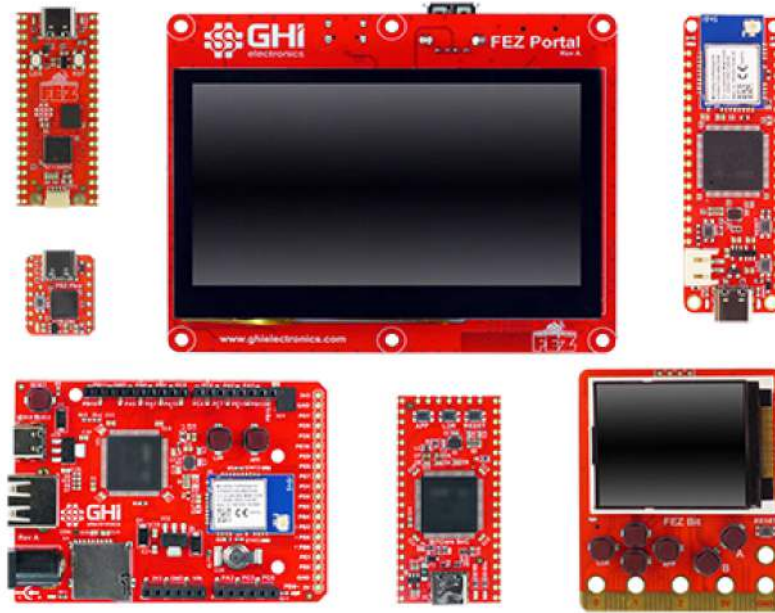

We offer multiple single board computers to provide the lowest possible barrier to entering the world of TinyCLR OS. Most of these boards have WiFi and they all support the complete TinyCLR feature set. These boards are great for trying out TinyCLR OS, building prototypes, or incorporating into products.

Specifications and Peripherals

	FEZ Flea	FEZ Pico	FEZ Feather	FEZ Stick	FEZ Bit	Fez Duino	Fez Portal
Core	SC13048Q	SC13048Q	SC20100S	SC20100S	SC20100S	SC20100S	SC20260N
External SDRAM	X	X	X	X	X	X	32 MByte
External Flash	X	X	X	X	X	16 MByte	16 MByte
Display	X	X	X	X	1.8" 160x128	X	4.3" 480x272 Cap. Touch
Click Connectors	X	X	X	2	X	X	1
WiFi	X	X	Yes	X	Yes	Yes	Yes
Micro SD	X	X	X	X	Yes	Yes	Yes
User LED	Yes	Yes	Yes	Yes	Yes	Yes	Yes

Buzzer	X	X	X	X	Yes	X	Yes
Accelerometer	X	X	X	X	Yes	X	X
User Buttons	X	X	Yes	Yes	Yes	Yes	Yes
USB Client	Yes	Yes	Yes	Yes	Yes	Yes	Yes
USB Host Connector	X	X	X	Yes	X	Yes	Yes
LiPo Charger	X	X	Yes	X	X	X	X
Power Barrel	X	X	X	X	X	Yes	X
GPIO	11	26	31	33	19	38	45
SPI	1	2	2	2	1	2	3
I2C	2	1	1	2	1	2	1
UART	3 (1 w/ HS)	3 (1 w/ HS)	5 (1 w/ HS)	2 (0 w/ HS)	3 (0 w/ HS)	5 (2 w/ HS)	6 (1 w/ HS)
CAN	X	1	1	1	1	1	2
PWM	4	7	8	6	8	12	17
ADC	6	6	6	3	8	11	10
DAC	2	2	1	X	1	2	2
SD/SDIP/MMC	X	X	1	1	1	1	1

Note: As many pins share peripherals, not all peripherals will be available.

Power Consumption

The 'Running' power consumption totals include all other on board components, such as WiFi & Display.

FEZ Flea/Pico Power

	80MHz	40MHz
Running	12.6mA	7.5mA
Idle	6.2mA	4.2mA
Sleep	1.4mA	1.4mA
Shutdown	23uA	23uA

FEZ Duino/Stick/Feather Power

	480MHz	240MHz
Running	205mA	110mA
Idle	170mA	97mA
Sleep	6.5mA	6.5mA
Shutdown	40uA	40uA

i TIP

Enabling WiFi (when available) adds up to 300mA. Battery charging on FEZ Feather adds up to 500mA.

FEZ Bit Power

	480MHz	240MHz
Running	232mA	140mA
Idle	190mA	127mA
Sleep	8.5mA	8.5mA
Shutdown	90uA	90uA

i TIP

Display backlight is included when Running and in Idle, but off in Sleep and Shutdown.

i TIP

Enabling WiFi adds up to 300mA.

FEZ Portal Power

	480MHz	240MHz
Running	375mA	345mA
Idle	270mA	255mA
Sleep	17mA	17mA

	480MHz	240MHz
Shutdown	9.7mA	9.7mA

i TIP

Display backlight is included when Running and in Idle, but off in Sleep and Shutdown.

i TIP

Enabling WiFi adds up to 300mA.

See the **Power Management** tutorial

USB-C Functionality

All SITCore single board computers use a USB-C connector for application deployment and debugging. While USB-C has many advantages, we've also noticed some flaws. Every USB-A to USB-C cable tested worked as expected. Testing USB-C to USB-C cables gave interesting and unexpected results. Most USB-C hubs also do not work when using USB-C to USB-C cables. If you are having problems deploying or debugging, try connecting the board directly to your computer with a USB-A to USB-C cable.

FEZ Flea

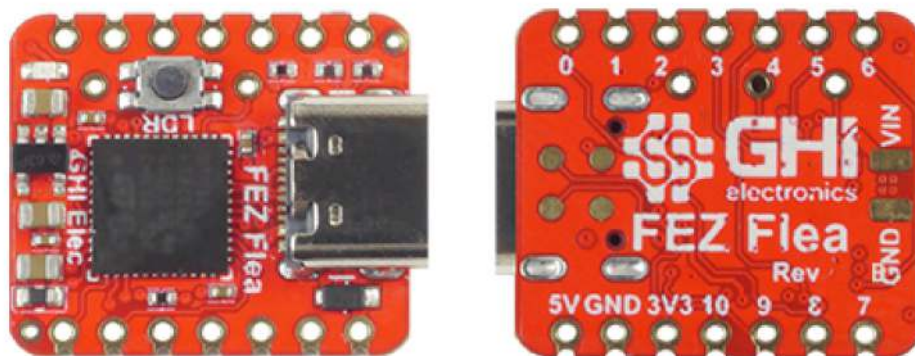

The **FEZ Flea** is the most cost effective way to dive into TinyCLR OS. With it's Seeeduino Xiao form factor it can be used with many existing accessories on the market. The board also has castellated and through-hole pins. Making it ideal for using as a SoM or on a breadboard.

FEZ Flea Schematic

FEZ Flea STEP file

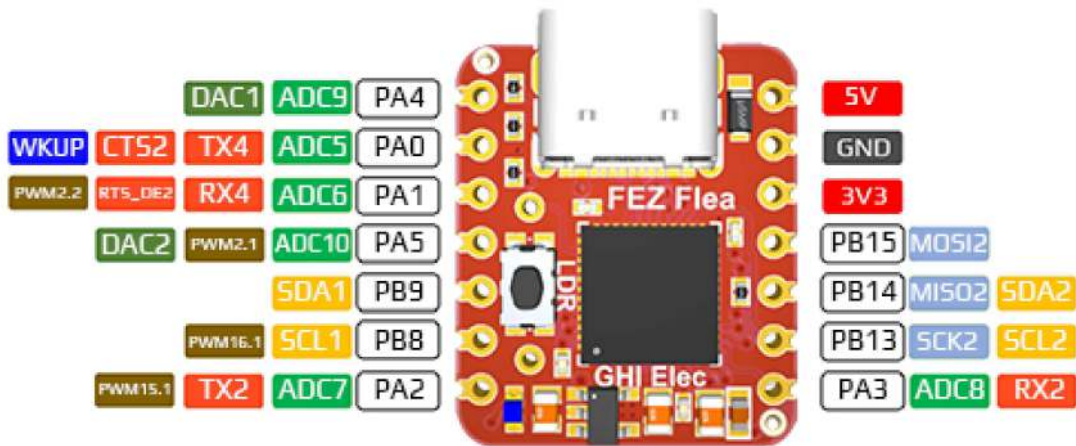

FEZ Flea Peripheral Pin

User LED	PA8
Button	LDR = PC13

FEZ Pico

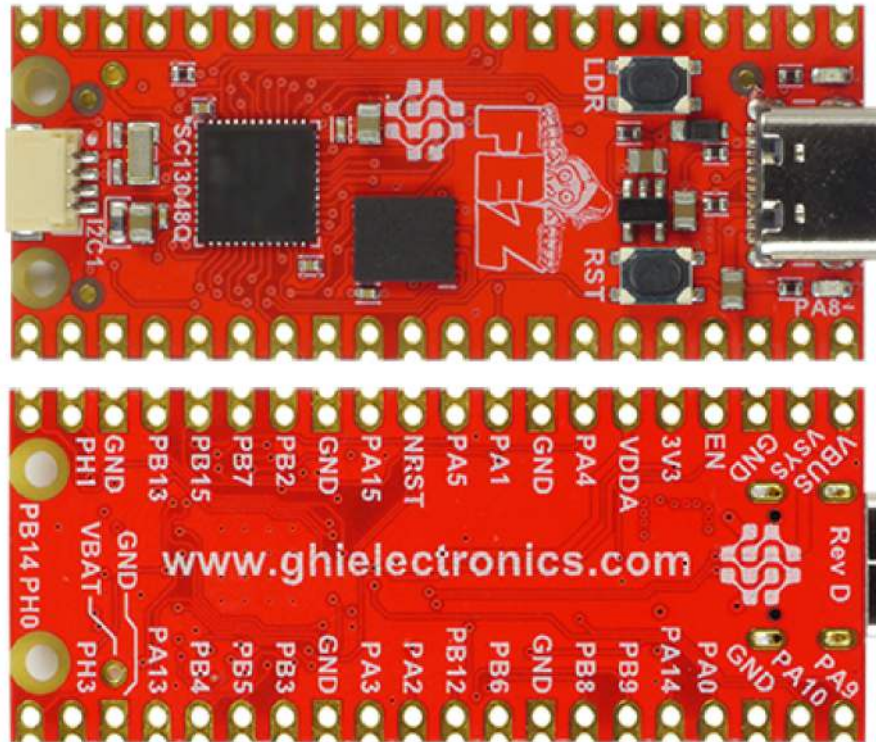

The **FEZ Pico** uses the Raspberry Pi Pico form factor allowing it drop into existing Pico accessories. The FEZ Pico adds JST connector compatible with Sparkfun Qwiic modules and Adafruit STEMMA modules. This allows for easy expandability.

FEZ Pico Schematic

FEZ Pico STEP file

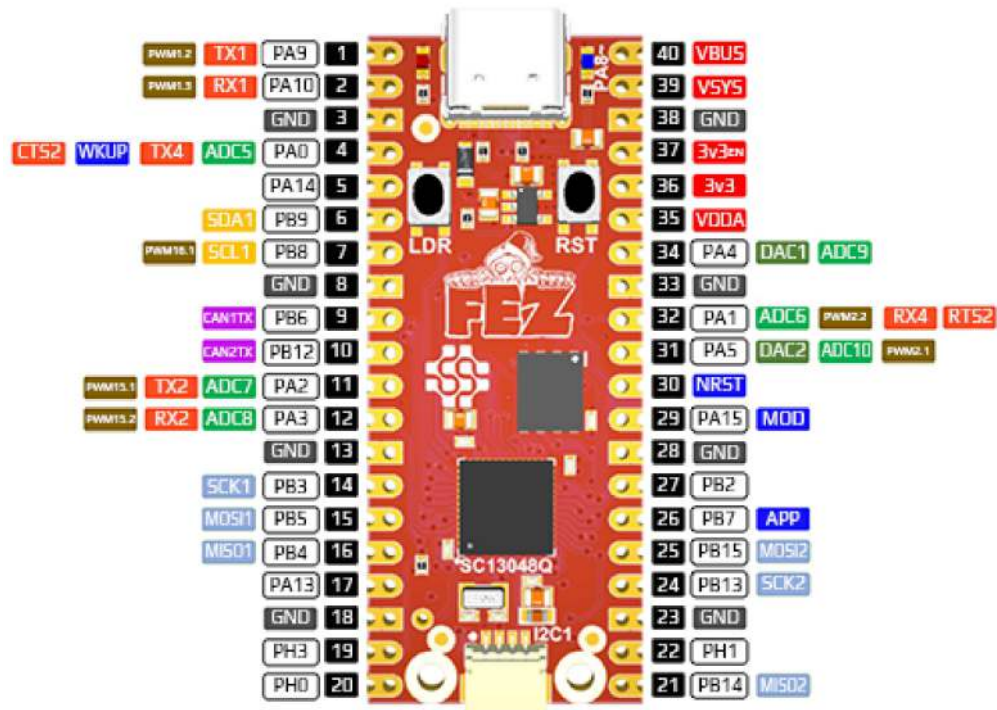

FEZ Pico Peripheral Pin

User LED	PA8
Button	LDR = PC13

FEZ Feather

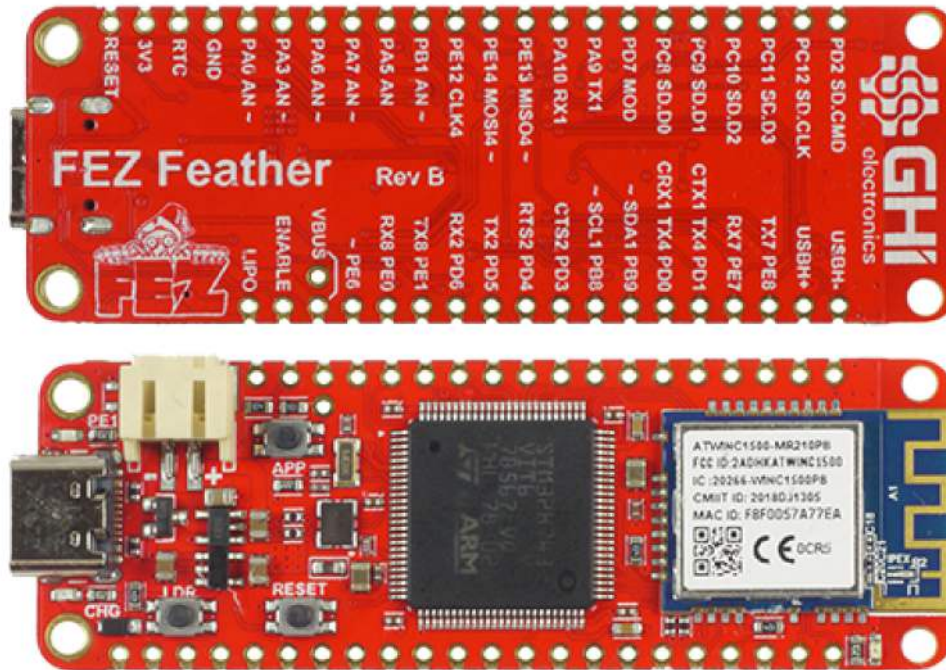

The Adafruit Feather form factor boards are made to be stackable and have built-in support for 3.7V LiPo batteries with a charging circuit. The **FEZ Feather** provides both through hole pads and castellated edges making it both breadboard friendly and easy to build into products.

⚠ CAUTION

Lithium Polymoer(Li-Po) batteries are significantly more volatile than other rechargeable batteries. Make sure you have an understanding of how to properly charge and use them before connecting to the FEZ Feather. Never attempt to charge a damaged or swollen battery. Never leave battery charging unattended. Improper use could result in fire.

⚠ WARNING

Be very careful to ensure the correct polarity of LiPo batteries before connecting them to the FEZ Feather. Reverse polarity will damage the charging circuit, and not all batteries are wired correctly. GHI Electronics is not responsible for, and will not warranty, damage caused by incorrectly connected batteries.

Make sure the battery polarity is correct as shown below (red wire to plus, black to minus):

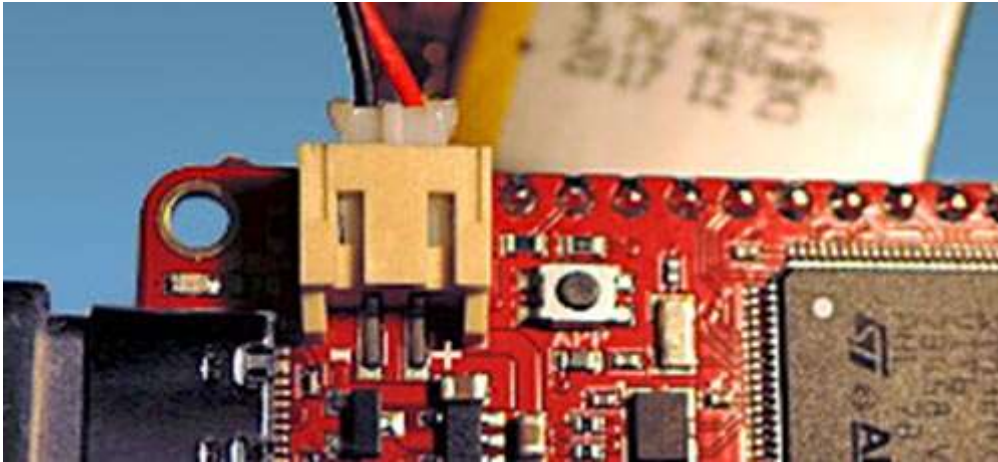

⚠ CAUTION

The 3.3v regulator may run hot, especially when WiFi is in use. You can add 3.3V regulator externally to eliminate this heat issue, and this is needed if adding any external components that draw more than 10mA.

[FEZ Feather Schematic](#)

[FEZ Feather 3D STEP File](#)

FEZ Feather Peripheral Pins

User LED	PE11
WiFi	SPI = SPI3
	IRQ = PB12
	CS = PD15
	EN = PA8
	RST = PB13
Buttons	LDR = PE3
	APP = PB7

i NOTE

FEZ Stick REV. B pin PB13 MISO is mislabeled on the silk screen and should read PE13 MISO

⚠ CAUTION

The onboard 3.3v regulator is only capable of running external components of an additional 50mA. If more current is necessary, then add an additional external 3.3V regulator.

FEZ Stick Schematic

FEZ Stick 3D STEP File

FEZ Stick Peripheral Pins

User LED	PE11
Buttons	LDR = PE3
	APP = PB7

FEZ Bit

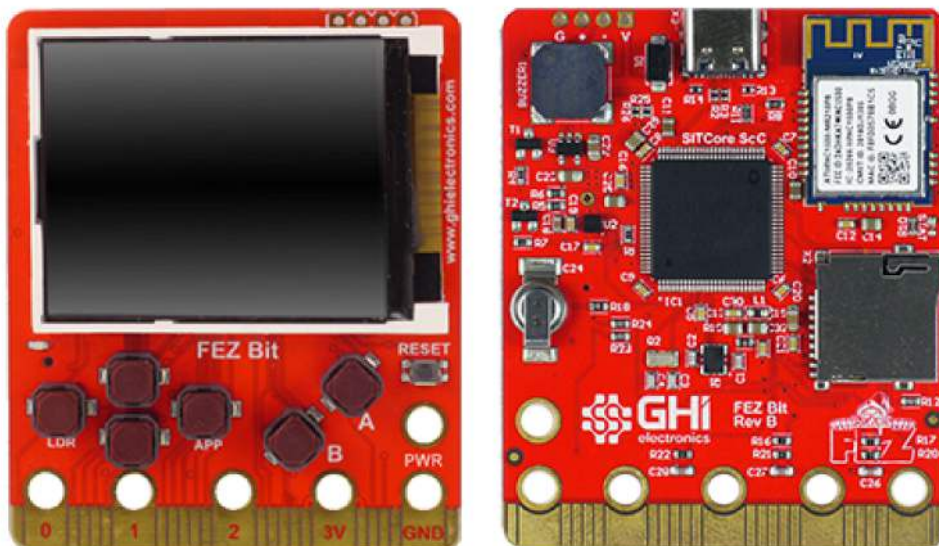

The **FEZ Bit**, while seemingly more of a "maker" board, provides a convenient way to easily use the multitude of inexpensive Micro:bit accessories that have flooded the market. As the number of Micro:bit accessories continues to grow, this board will be valued as a way to use these accessories to quickly assemble prototypes and test new product concepts.

⚠ CAUTION

The 3.3v regulator may run hot, especially when WiFi is in use. You can add 3.3V regulator externally to eliminate this heat issue, and this is needed if adding any external components that draw more than 10mA.

FEZ Bit Schematic

FEZ Bit 3D STEP File

FEZ Bit Peripheral Pins

User LED	PE11
Buzzer	PB1
Accelerometer	I2C = I2C1
SPI Display	SPI = SPI4
	BL = PA15
	CS = PD10
	RS = PC4
	RST = PE15
WiFi	SPI = SPI3
	IRQ = PB12
	CS = PD15
	EN = PA8
	RST = PB13
Buttons	LDR = PE3
	APP = PB7
	UP = PE4
	DOWN = PA1
	A = PE5
	B = PE6
Edge Connector	P0 = PC6 (PC2 Analog)

	P1 = PC7 (PA3 Analog)
	P2 = PA0
	P3 = PB0
	P4 = PA4
	P5 = PD13
	P6 = PD12
	P7 = PD11
	P8 = PE8
	P9 = PC3
	P10 = PC0
	P11 = PD1
	P12 = PD0
	P13 = PA5
	P14 = PA6
	P15 = PA7
	P16 = PE7
	P19 = PB8
	P20 = PB9

 NOTE

All boards with a barrel power jack accept a 5.5 x 2.1 mm power plug. The pin is positive, the sleeve is negative. While these boards accept a wide voltage range, they use linear voltage regulators that run hotter with higher input voltages. Generally we recommend an input voltage of 6 to 12 volts, but if your project draws a lot of current, use a lower voltage to keep the regulator cooler. A one amp power supply should provide enough current for most needs.

FEZ Duino

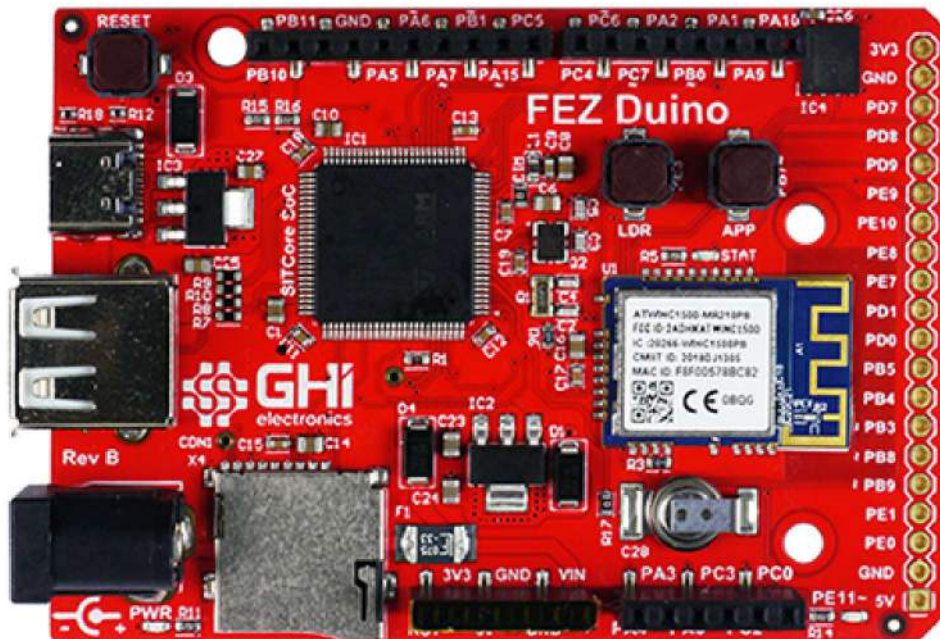

The **FEZ Duino** provides female headers that make use of the popular Arduino pinout. Once again, we are trying to make it as easy and inexpensive as possible to build prototypes and try out new concepts by taking advantage of an existing accessory ecosystem.

FEZ Duino Schematic

FEZ Duino 3D STEP File

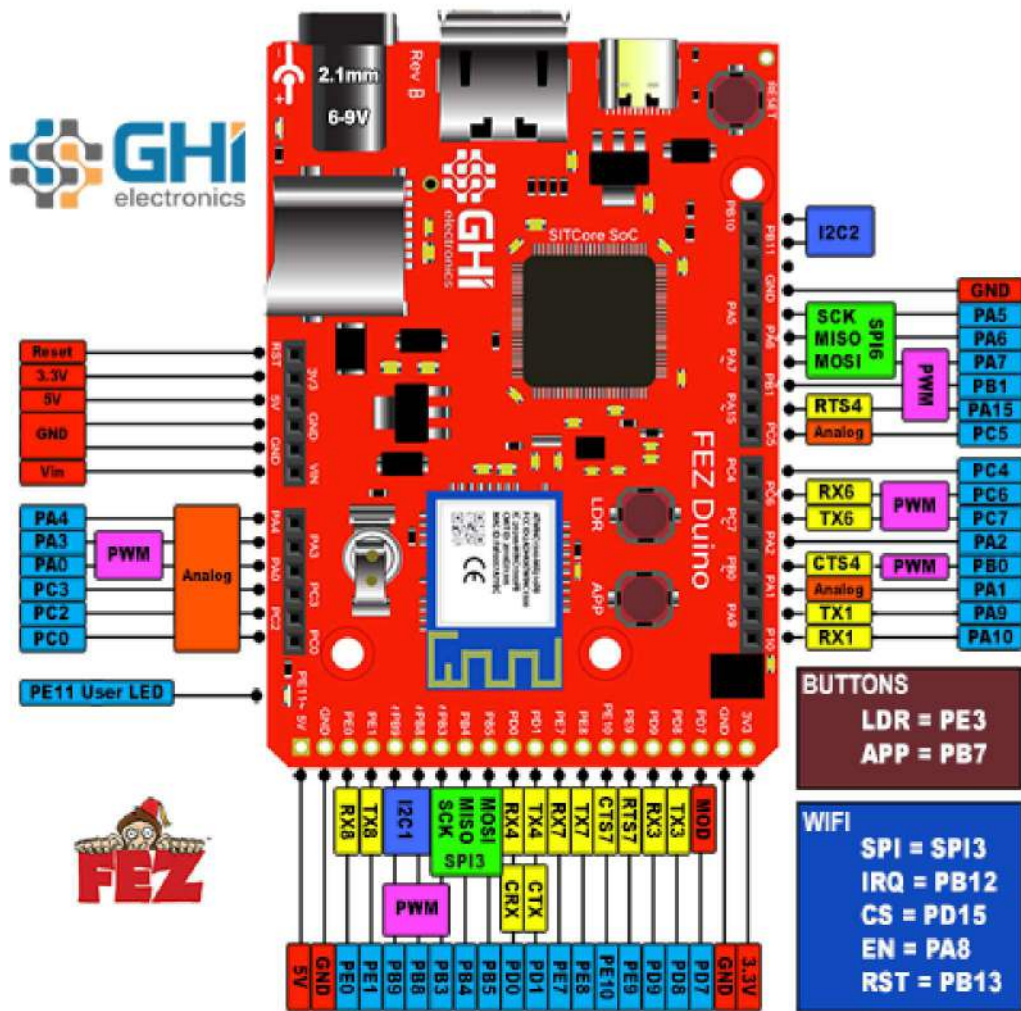

FEZ Duino Peripheral Pins

User LED	PE11
WiFi	SPI = SPI3
	IRQ = PB12
	CS = PD15
	EN = PA8
	RST = PB13
Buttons	LDR = PE3
	APP = PB7

⚠ WARNING

FEZ Duino REV. A & B, The cap used on barrel jack is 6.3v but the input voltage can be as high as 12v. Use the barrel jack at your own risk or replace cap with a higher voltage. This only effects the power barrel jack. Everything else functions as expected if using USB for power.

FEZ Portal

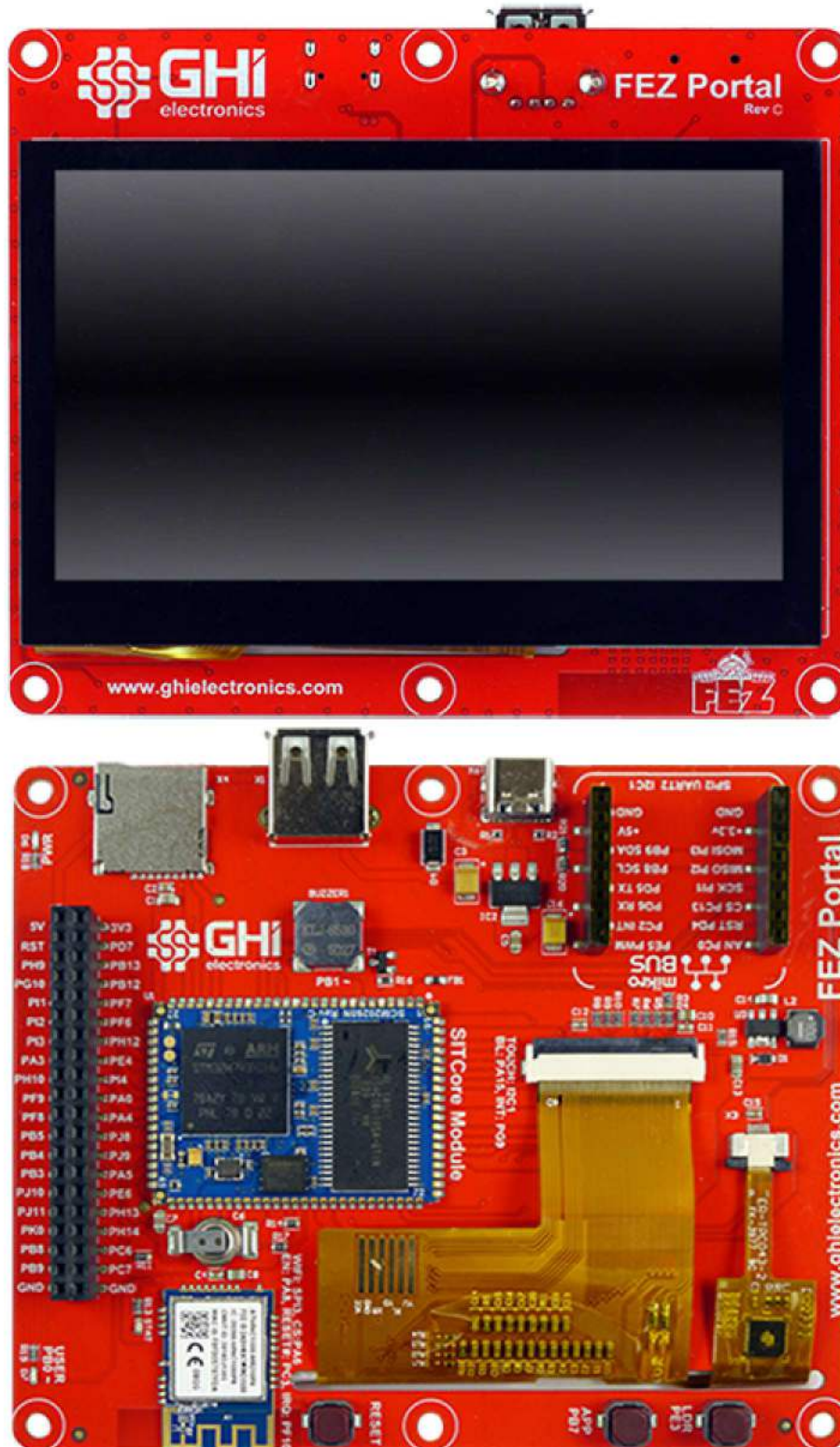

Already one of our most popular SITCore single board computers, The **FEZ Portal** is a 4.3" 480x272 display with capacitive touch that is programmable in C#. As the display and controller are one unit, it's even easier to make a product with touch as you only have to mount a single board that's only slightly larger than the display.

Display uses part# ER-TFT043-3 available at [buydisplay.com](https://www.buydisplay.com/) (<https://www.buydisplay.com/>)

NOTE

I2C address on touch screen controller is 0x38. Use software I2C if a device has same address need to be connected.

FEZ Portal Schematic

FEZ Portal 3D STEP File

FEZ Portal Peripheral Pins

User LED	PB0
Buzzer	PB1
Display	BL = PA15
	Touch I2C = I2C1
	Touch I2C Address = 0x38
	Touch IRQ = PG9
WiFi	SPI = SPI3
	IRQ = PF10
	CS = PA6
	EN = PA8
	RST = PC3
Buttons	LDR = PE3
	APP = PB7

You can visit our main website at www.ghielectronics.com
our community forums at forums.ghielectronics.com
and our documentation at docs.ghielectronics.com