

Utilizing the latest Field Stop and Trench Gate technologies, these IGBT's have ultra low  $V_{CE(ON)}$  and are ideal for low frequency applications that require absolute minimum conduction loss. Easy paralleling is a result of very tight parameter distribution and a slightly positive  $V_{CE(ON)}$  temperature coefficient. Low gate charge simplifies gate drive design and minimizes losses.

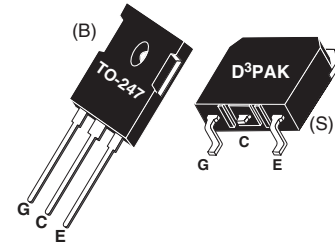

- 600V Field Stop
- Trench Gate: Low  $V_{CE(on)}$
- Easy Paralleling
- 6 $\mu$ s Short Circuit Capability
- 175°C Rated

**Applications: Welding, Inductive Heating, Solar Inverters, SMPS, Motor drives, UPS**

### MAXIMUM RATINGS

All Ratings:  $T_C = 25^\circ\text{C}$  unless otherwise specified.

Symbol	Parameter	APT30GN60B_S(G)	UNIT
$V_{CES}$	Collector-Emitter Voltage	600	Volts
$V_{GE}$	Gate-Emitter Voltage	$\pm 30$	
$I_{C1}$	Continuous Collector Current @ $T_C = 25^\circ\text{C}$	63	Amps
$I_{C2}$	Continuous Collector Current @ $T_C = 110^\circ\text{C}$	37	
$I_{CM}$	Pulsed Collector Current <sup>①</sup>	90	
SSOA	Switching Safe Operating Area @ $T_J = 150^\circ\text{C}$	90A @ 600V	
$P_D$	Total Power Dissipation	203	Watts
$T_J, T_{STG}$	Operating and Storage Junction Temperature Range	-55 to 175	$^\circ\text{C}$
$T_L$	Max. Lead Temp. for Soldering: 0.063" from Case for 10 Sec.	300	

### STATIC ELECTRICAL CHARACTERISTICS

Symbol	Characteristic / Test Conditions	MIN	TYP	MAX	Units
$V_{(BR)CES}$	Collector-Emitter Breakdown Voltage ( $V_{GE} = 0V, I_C = 2mA$ )	600			Volts
$V_{GE(TH)}$	Gate Threshold Voltage ( $V_{CE} = V_{GE}, I_C = 430\mu A, T_j = 25^\circ\text{C}$ )	5.0	5.8	6.5	
$V_{CE(ON)}$	Collector-Emitter On Voltage ( $V_{GE} = 15V, I_C = 30A, T_j = 25^\circ\text{C}$ )	1.1	1.5	1.9	
	Collector-Emitter On Voltage ( $V_{GE} = 15V, I_C = 30A, T_j = 125^\circ\text{C}$ )		1.7		
$I_{CES}$	Collector Cut-off Current ( $V_{CE} = 600V, V_{GE} = 0V, T_j = 25^\circ\text{C}$ ) <sup>②</sup>			25	$\mu A$
	Collector Cut-off Current ( $V_{CE} = 600V, V_{GE} = 0V, T_j = 125^\circ\text{C}$ ) <sup>②</sup>			TBD	
$I_{GES}$	Gate-Emitter Leakage Current ( $V_{GE} = \pm 20V$ )			300	nA
$R_{G(int)}$	Intergrated Gate Resistor		N/A		$\Omega$



**CAUTION:** These Devices are Sensitive to Electrostatic Discharge. Proper Handling Procedures Should Be Followed.

## DYNAMIC CHARACTERISTICS

APT30GN60B\_S(G)

Symbol	Characteristic	Test Conditions	MIN	TYP	MAX	UNIT	
$C_{ies}$	Input Capacitance	<b>Capacitance</b> $V_{GE} = 0V, V_{CE} = 25V$ $f = 1 \text{ MHz}$		1750		pF	
$C_{oes}$	Output Capacitance			70			
$C_{res}$	Reverse Transfer Capacitance			50			
$V_{GEP}$	Gate-to-Emitter Plateau Voltage	Gate Charge $V_{GE} = 15V$ $V_{CE} = 300V$ $I_C = 30A$		9.0		V	
$Q_g$	Total Gate Charge <sup>③</sup>			165			
$Q_{ge}$	Gate-Emitter Charge			10			
$Q_{gc}$	Gate-Collector ("Miller") Charge			90			
SSOA	Switching Safe Operating Area	$T_J = 150^\circ\text{C}, R_G = 4.3\Omega^{\text{⑦}}, V_{GE} = 15V, L = 100\mu\text{H}, V_{CE} = 600V$	90			A	
SCSOA	Short Circuit Safe Operating Area	$V_{CC} = 360V, V_{GE} = 15V, T_J = 150^\circ\text{C}, R_G = 4.3\Omega^{\text{⑦}}$	6			$\mu\text{s}$	
$t_{d(on)}$	Turn-on Delay Time	<b>Inductive Switching (25°C)</b> $V_{CC} = 400V$ $V_{GE} = 15V$ $I_C = 30A$ $R_G = 4.3\Omega^{\text{⑦}}$ $T_J = +25^\circ\text{C}$		12		ns	
$t_r$	Current Rise Time			14			
$t_{d(off)}$	Turn-off Delay Time			155			
$t_f$	Current Fall Time			55			
$E_{on1}$	Turn-on Switching Energy <sup>④</sup>				525		$\mu\text{J}$
$E_{on2}$	Turn-on Switching Energy (With Diode) <sup>⑤</sup>				565		
$E_{off}$	Turn-off Switching Energy <sup>⑥</sup>				700		
$t_{d(on)}$	Turn-on Delay Time		<b>Inductive Switching (125°C)</b> $V_{CC} = 400V$ $V_{GE} = 15V$ $I_C = 30A$ $R_G = 4.3\Omega^{\text{⑦}}$ $T_J = +125^\circ\text{C}$		12		ns
$t_r$	Current Rise Time				14		
$t_{d(off)}$	Turn-off Delay Time				180		
$t_f$	Current Fall Time			75			
$E_{on1}$	Turn-on Switching Energy <sup>④</sup>				555		$\mu\text{J}$
$E_{on2}$	Turn-on Switching Energy (With Diode) <sup>⑤</sup>				950		
$E_{off}$	Turn-off Switching Energy <sup>⑥</sup>				895		

## THERMAL AND MECHANICAL CHARACTERISTICS

Symbol	Characteristic	MIN	TYP	MAX	UNIT
$R_{\theta JC}$	Junction to Case ( <b>IGBT</b> )			.74	$^\circ\text{C/W}$
$R_{\theta JC}$	Junction to Case ( <b>DIODE</b> )			N/A	
$W_T$	Package Weight		5.9		gm

① Repetitive Rating: Pulse width limited by maximum junction temperature.

② For Combi devices,  $I_{ces}$  includes both IGBT and diode leakages

③ See MIL-STD-750 Method 3471.

④  $E_{on1}$  is the clamped inductive turn-on energy of the IGBT only, without the effect of a commutating diode reverse recovery current adding to the IGBT turn-on loss. Tested in inductive switching test circuit shown in figure 21, but with a Silicon Carbide diode.

⑤  $E_{on2}$  is the clamped inductive turn-on energy that includes a commutating diode reverse recovery current in the IGBT turn-on switching loss. (See Figures 21, 22.)

⑥  $E_{off}$  is the clamped inductive turn-off energy measured in accordance with JEDEC standard JESD24-1. (See Figures 21, 23.)

⑦  $R_G$  is external gate resistance, not including  $R_{Gint}$  nor gate driver impedance. (MIC4452)

Microsemi reserves the right to change, without notice, the specifications and information contained herein.

**TYPICAL PERFORMANCE CURVES**

**APT30GN60B\_S(G)**

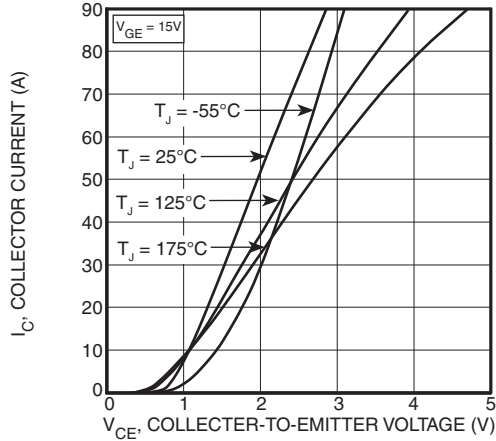

**FIGURE 1, Output Characteristics ( $T_J = 25^\circ\text{C}$ )**

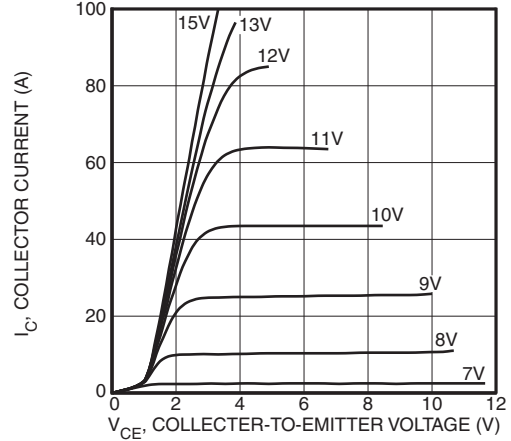

**FIGURE 2, Output Characteristics ( $T_J = 125^\circ\text{C}$ )**

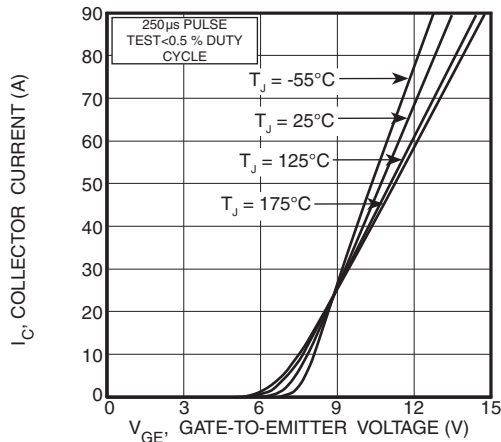

**FIGURE 3, Transfer Characteristics**

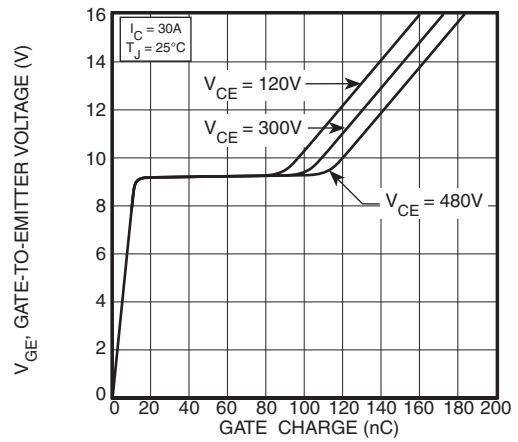

**FIGURE 4, Gate Charge**

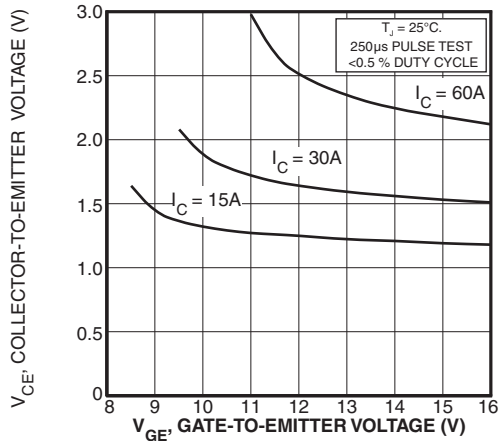

**FIGURE 5, On State Voltage vs Gate-to-Emitter Voltage**

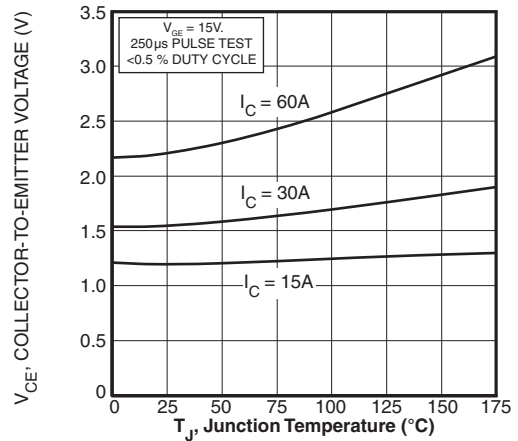

**FIGURE 6, On State Voltage vs Junction Temperature**

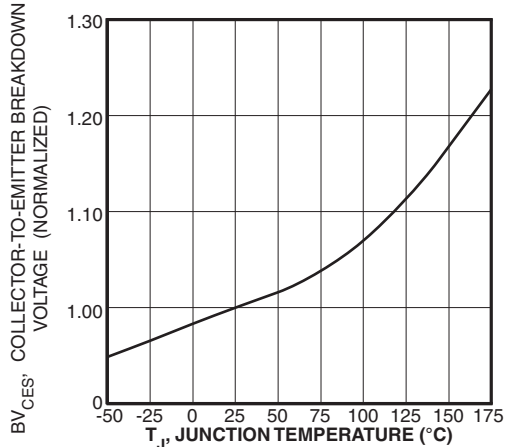

**FIGURE 7, Breakdown Voltage vs. Junction Temperature**

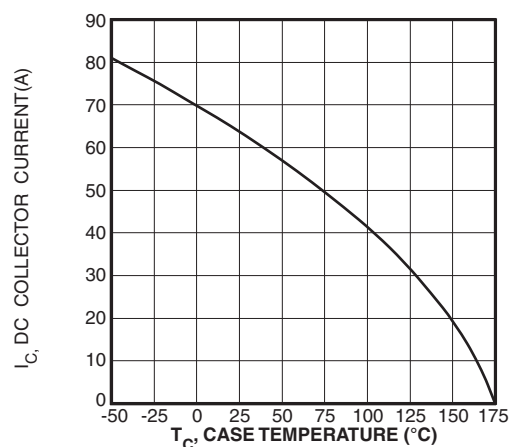

**FIGURE 8, DC Collector Current vs Case Temperature**

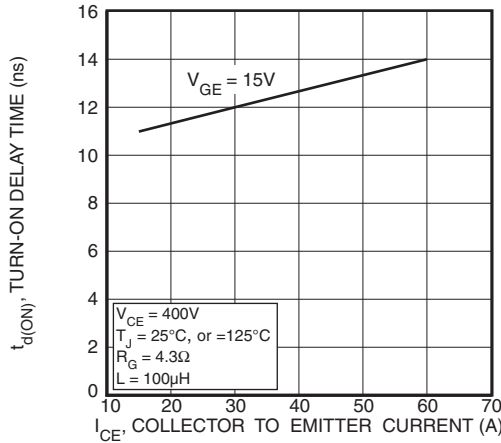

FIGURE 9, Turn-On Delay Time vs Collector Current

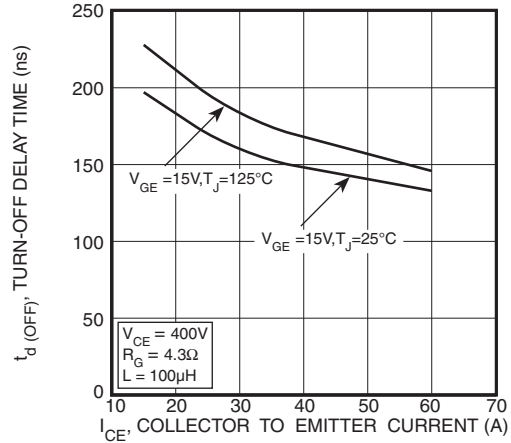

FIGURE 10, Turn-Off Delay Time vs Collector Current

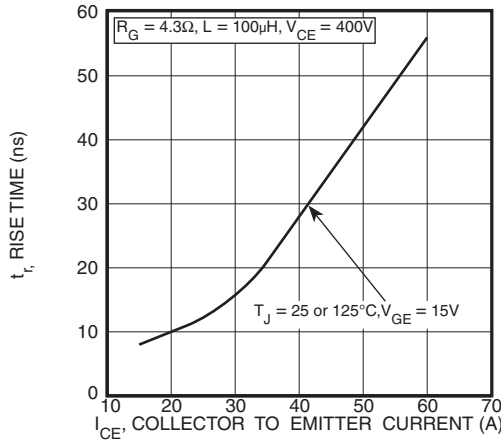

FIGURE 11, Current Rise Time vs Collector Current

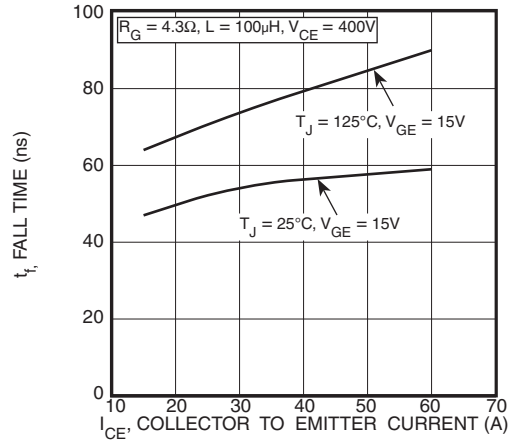

FIGURE 12, Current Fall Time vs Collector Current

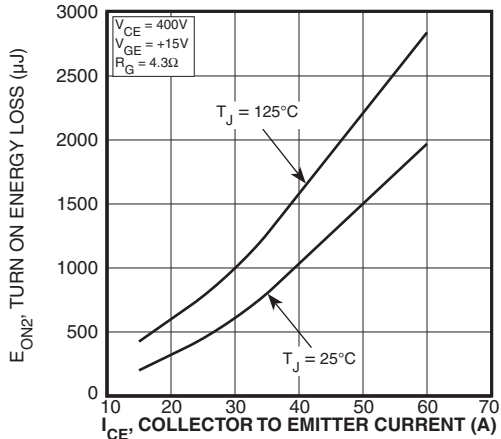

FIGURE 13, Turn-On Energy Loss vs Collector Current

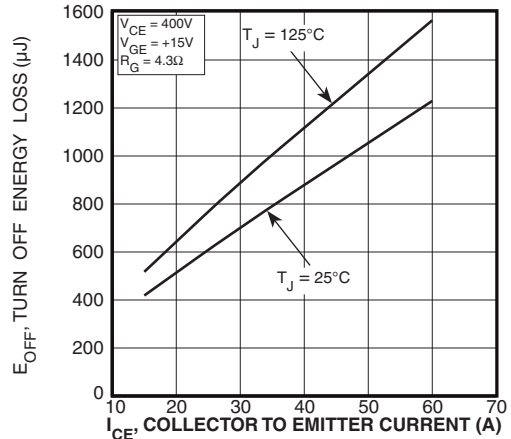

FIGURE 14, Turn Off Energy Loss vs Collector Current

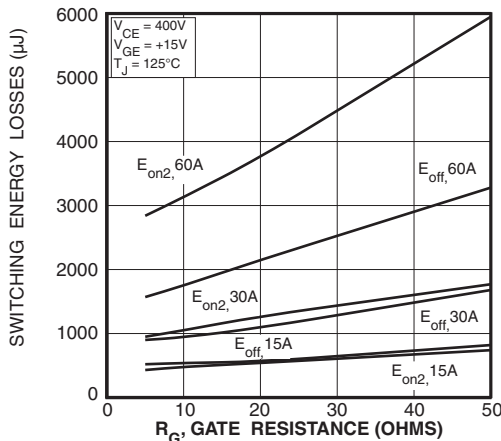

FIGURE 15, Switching Energy Losses vs. Gate Resistance

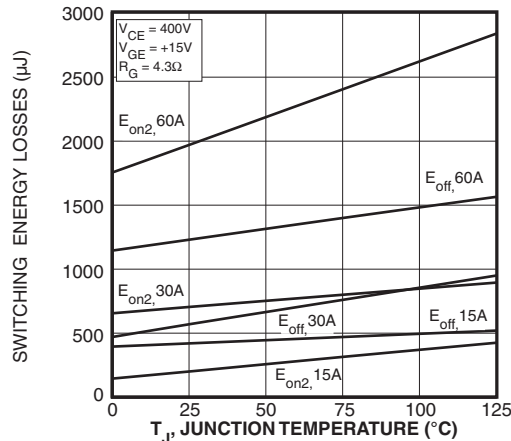
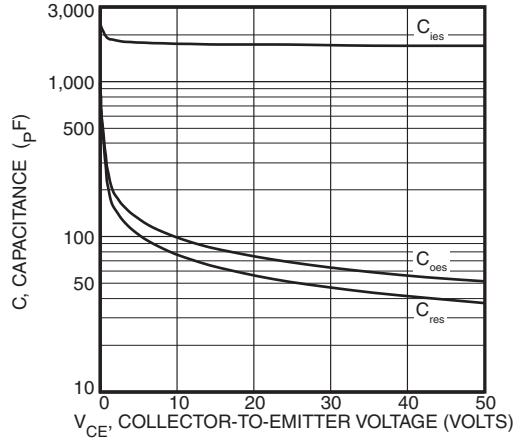

FIGURE 16, Switching Energy Losses vs Junction Temperature

**TYPICAL PERFORMANCE CURVES**

**APT30GN60B\_S(G)**



**Figure 17, Capacitance vs Collector-To-Emitter Voltage**

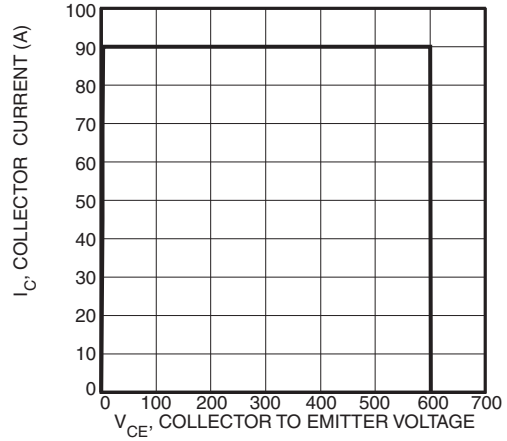

**Figure 18, Minimum Switching Safe Operating Area**

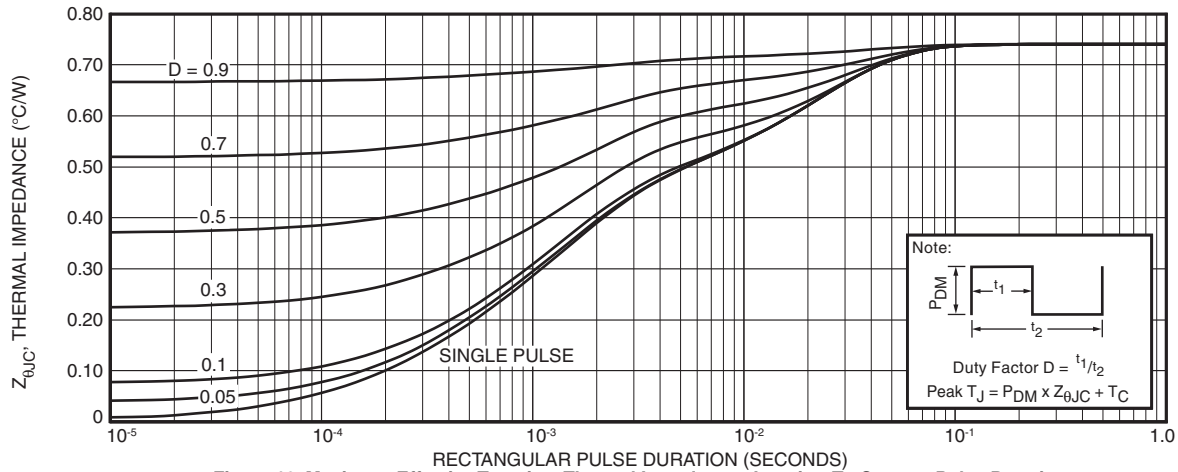

**Figure 19, Maximum Effective Transient Thermal Impedance, Junction-To-Case vs Pulse Duration**

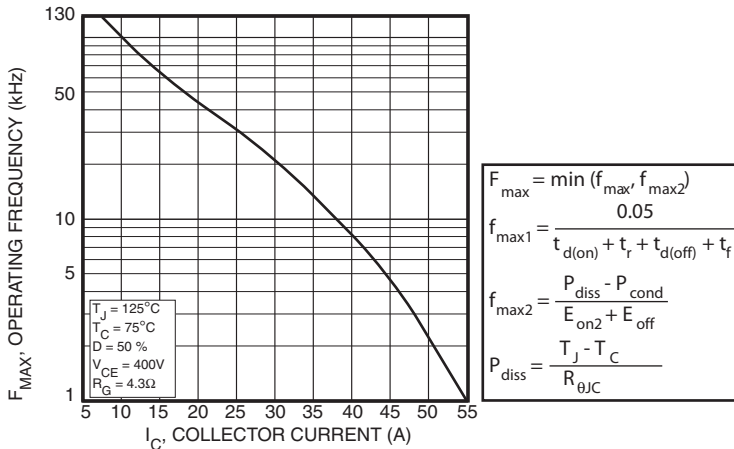

**Figure 20, Operating Frequency vs Collector Current**

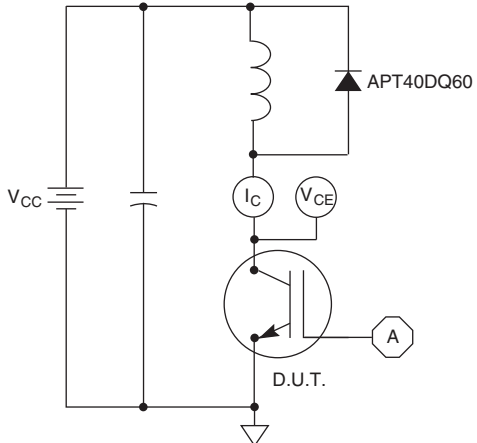

Figure 21, Inductive Switching Test Circuit

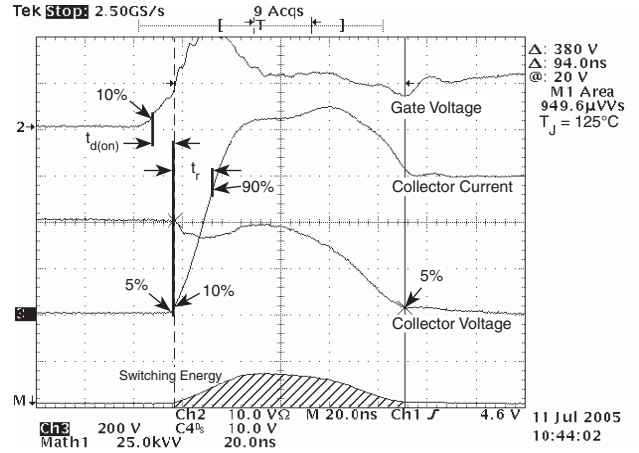

Figure 22, Turn-on Switching Waveforms and Definitions

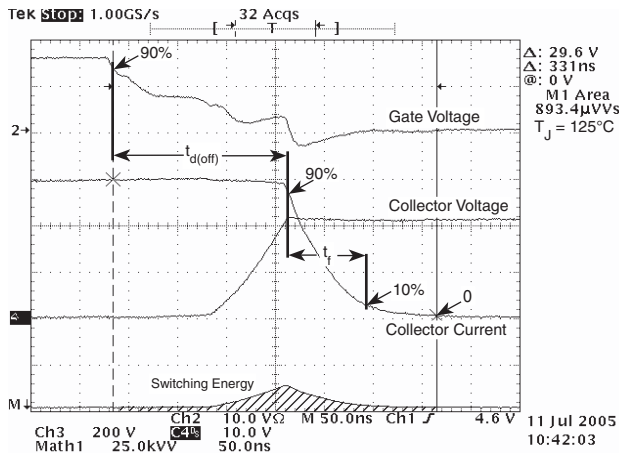
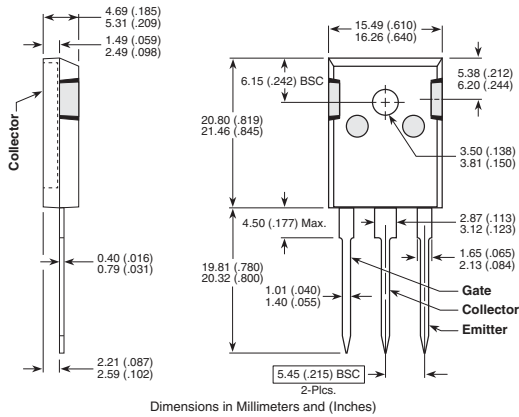

Figure 23, Turn-off Switching Waveforms and Definitions

### TO-247 Package Outline

e1 SAC: Tin, Silver, Copper



### D<sup>3</sup>PAK Package Outline

e3 SAC: Tin, Silver, Copper

