

PART NO. FPI SINGLE-__

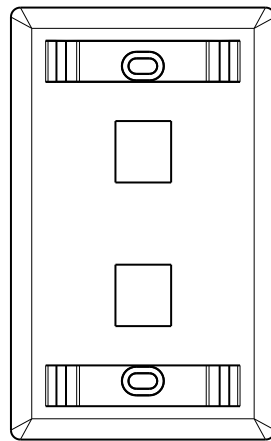

PART NO. FPI DUAL-__

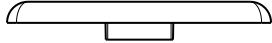
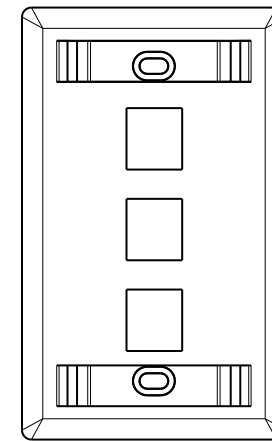
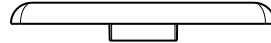

PART NO. FPI TRIPLE-__

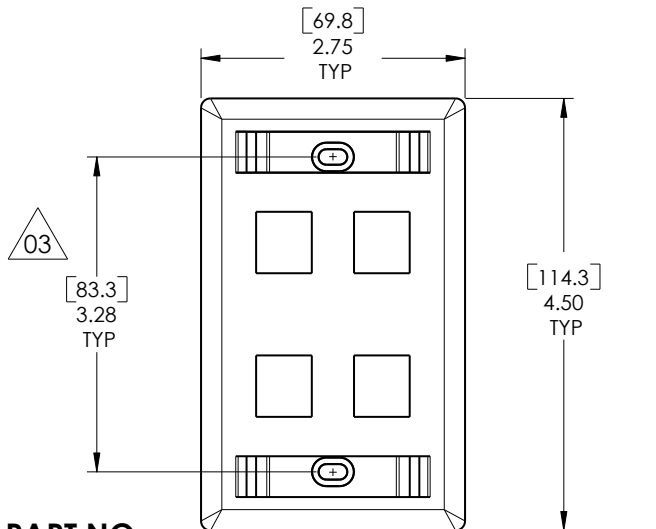
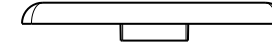

PART NO. FPI QUAD-__

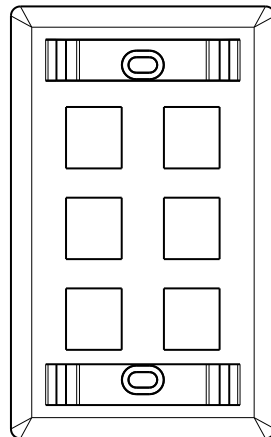
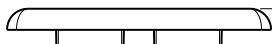

PART NO. FPI SIX-__

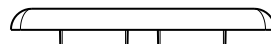

[5.6] .22 TYP

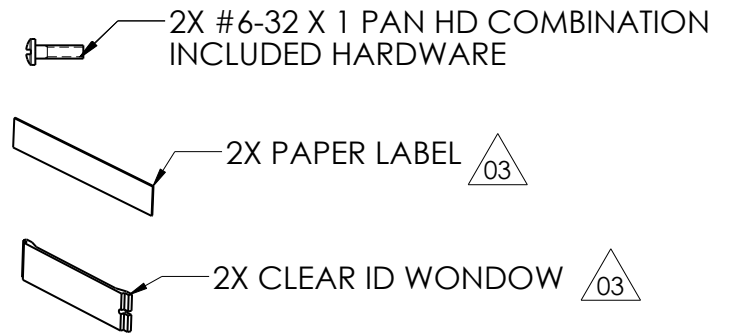

PRODUCT CODE DESCRIPTION

FPI SINGLE - COLOR

I = IVORY FW = OFFICE WHITE
 W = WHITE BK = BLACK
 GRY = GRAY B = BROWN

INVENTORS

HellermannTyton

ALL PROPRIETARY RIGHTS IN THE SUBJECT MATTER SHOWN ON THIS DRAWING ARE EXCLUSIVE PROPERTY OF HELLERMANN TYTON

name	date	city, state

REVISION

level	03
by	KAC
date	04/17/2006
ECN #	010402
part level	-

DIMENSIONS

TOLERANCES	.XXXX = [$\pm .013$]/ $\pm .0005$
	.XXX = [$\pm .13$]/ $\pm .005$
	.XX = [$\pm .3$]/ $\pm .01$
	.X = [$\pm .8$]/ $\pm .03$
	$\angle = \pm 0.5^\circ$
	unless otherwise specified
units	[millimeters]/inches

PART

number	SEE ABOVE	phase	Pre-Production
name	FPI ID FACEPLATES		
material	PVC UL94V-0		

DRAWING

format	AH	CAD	SW 2006	scale	1:2
computer file name	MI3013002CST_03		previous drawing number		
drawn	MEF	checked	K.A.C.	approved	
	12/14/2004		04/17/2006		
type	Customer	sheet 1 of 1			
number	MI3013002CST				