

N-channel enhancement mode linear RF power MOSFET
 Ideal for class AB and C industrial, scientific, medical, and commercial applications.

$V_{DSS} = 500\text{ V}$
 $I_{D25} = 10\text{ A}$

Features

- Isolated Substrate
 - high isolation voltage (>2500V)
 - excellent thermal transfer
 - Increased temperature and power cycling capability
- IXYS RF Low Capacitance Z-MOS™ Process
- Very low insertion inductance (<2nH)
- No beryllium oxide (BeO) or other hazardous materials

Advantages

- High Performance RF Package
- Easy to mount—no insulators needed

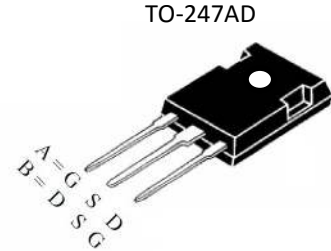
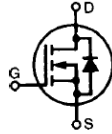

Maximum Ratings

Symbol	Parameter	Test Conditions	Maximum	Units
V_{DSS}	Drain-source voltage	$T_J = 25^\circ\text{C}$ to 150°C	500	V
V_{DGR}	Drain-gate voltage	$T_J = 25^\circ\text{C}$ to 150°C ; $R_{GS} = 1\text{ M}\Omega$	500	
V_{GS}	Gate-source voltage	Continuous	± 20	
V_{GSM}		Transient	± 30	
I_{D25}	Continuous drain current	$T_c = 25^\circ\text{C}$	10	A
P_{DC}	Package power dissipation per MOSFET	$T_c = 25^\circ\text{C}$	200	W
P_{DHS}	Dissipation to heat-sink per MOSFET	$T_c = 25^\circ\text{C}$, Derate $2\text{ W}/^\circ\text{C}$ above 25°C	150	
P_{DAMB}	Ambient power dissipation	$T_{AMB} = 25^\circ\text{C}$	3	
R_{thJC}	Thermal resistance junction to case		0.6	$^\circ\text{C}/\text{W}$
R_{thJHS}	Thermal resistance junction to heat-sink		0.85	
T_J, T_{STG}	Operating and storage junction temperature range		-55 to 150	$^\circ\text{C}$
T_L	Lead temperature	1.6mm(0.063 in) from case for 10 s	300	

Electrical Characteristics

Symbol	Parameter	Test Conditions	Min	Typ	Max	Units
--------	-----------	-----------------	-----	-----	-----	-------

Static

BV_{DSS}	Breakdown voltage drain to source	$V_{GS} = 0\text{ V}, I_D = 4\text{ ma}$	500			V
I_{DSS}	Drain leakage current	$V_{DS} = 0.8V_{DSS}$ $V_{GS} = 0$			50 1	μA mA
I_{GSS}	Gate leakage current	$V_{GS} = \pm 20\text{ V}_{DC}, V_{DS} = 0$			± 100	nA
g_{fs}	Transconductance	$V_{DS} = 60\text{ V}, I_D = 0.5I_{D25}$, pulse test		3.1		S
$V_{GS(th)}$	Threshold voltage	$V_{DS} = V_{GS}, I_D = 250\mu\text{A}$	4.0	5.4	6.5	V

Electrical Characteristics cont.

Symbol	Parameter	Test Conditions	Min	Typ	Max	Units
--------	-----------	-----------------	-----	-----	-----	-------

Dynamic

R_{DS(on)}	Drain to source ON resistance	$V_{GS} = 15\text{ V}$, $I_D = 0.5 I_{D25}$ Pulse test, $t \leq 300\mu\text{S}$, duty cycle $d \leq 2\%$		1		Ω
C_{ISS}	Input capacitance	$V_{GS} = 0\text{ V}$, $V_{DS} = 0.8 V_{DSS}$, $f = 1\text{ MHz}$		611		pF
C_{OSS}	Output capacitance			100		pF
C_{RSS}	Reverse transfer capacitance			6		pF
t_{D(ON)}	Turn-on delay time	$V_{GS} = 15\text{ V}$, $V_{DS} = 0.8 V_{DSS}$		4		ns
t_R	Rise time			3		ns
t_{D(OFF)}	Turn-off delay time			4		ns
t_F	Fall time			5		ns

CAUTION: Operation at or above the Maximum Ratings values may impact device reliability or cause permanent damage to the device.

Information in this document is believed to be accurate and reliable. IXYSRF reserves the right to make changes to information published in this document at any time and without notice.

For detailed device mounting and installation instructions, see the “*Device Installation & Mounting Instructions*” technical note on the IXYSRF web site;

All charts are per MOSFET

Fig. 1

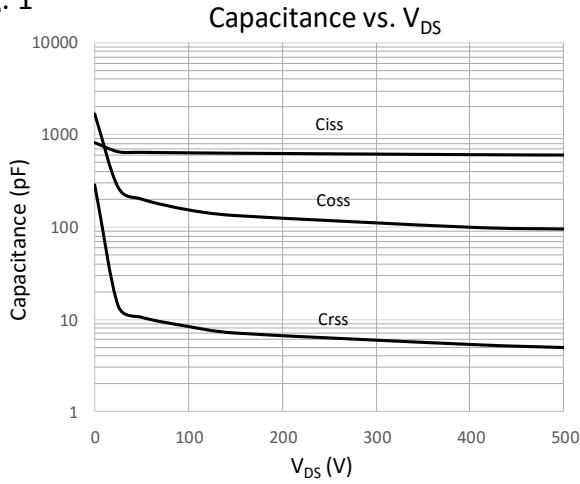

Fig. 2

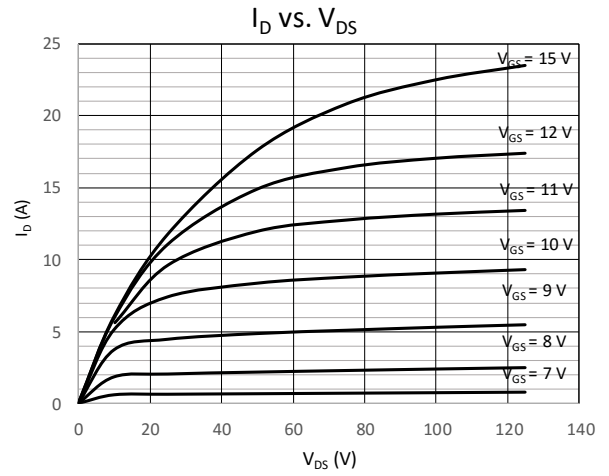

Fig. 3

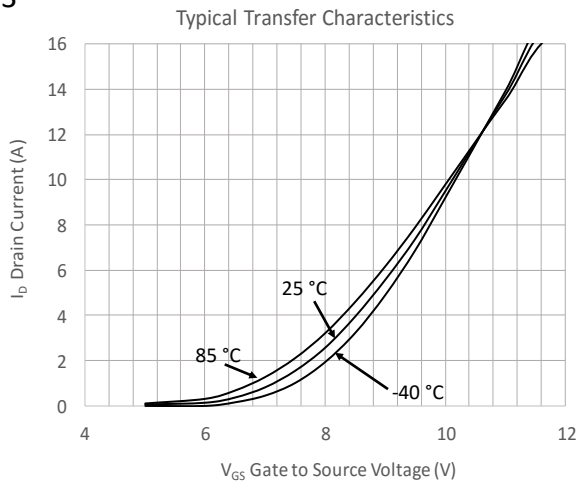

Fig. 4

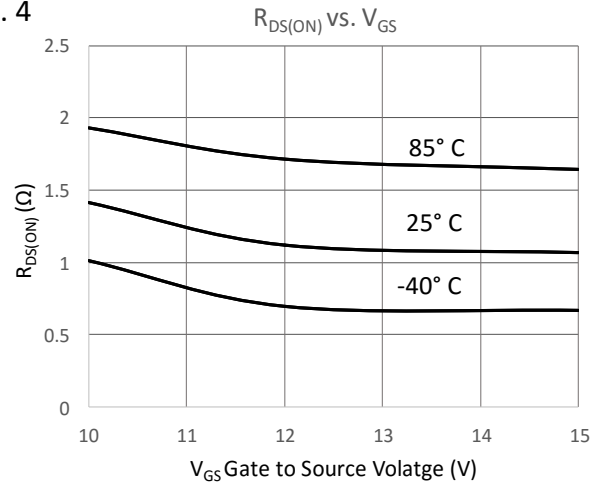

Fig. 5

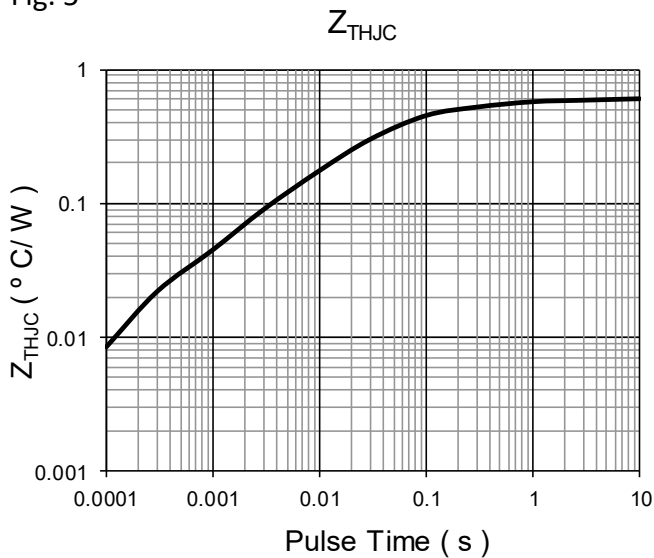

Fig. 6

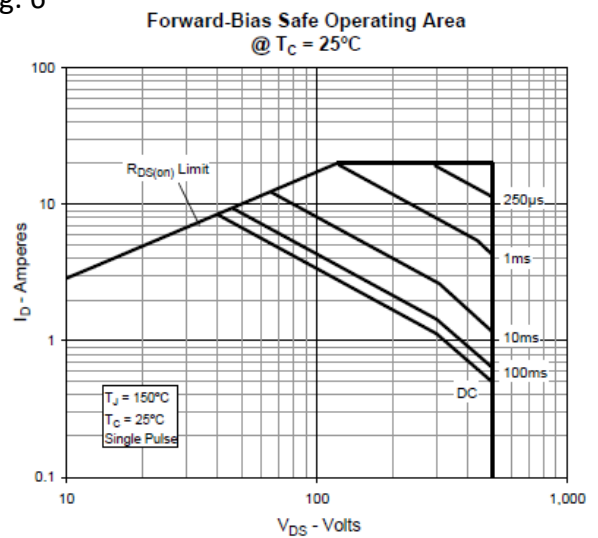

Fig. 7

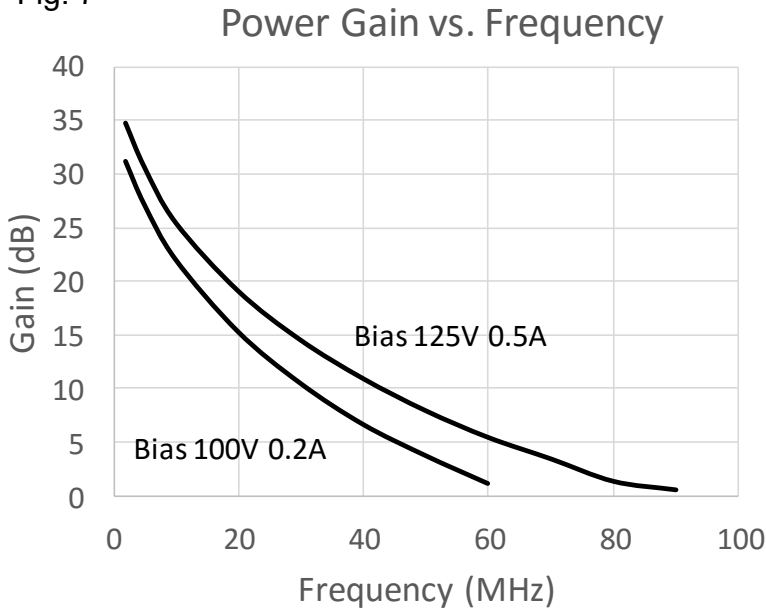

Table 1

S Parameters

 $V_{DS} = 100V$ $I_{BIAS} = 0.2A$

Freq. (MHz)	Mag. S11	Phase S11	Mag. S12	Phase S12	Mag. S21	Phase S21	Mag. S22	Phase S22
2	1	-56	0.011	66	35.6	155.4	0.886	-3.7
5	0.95	-106.4	0.018	31	23.2	118.6	0.727	-36
10	0.934	-138.5	0.019	5.4	12.6	92.9	0.664	-61
13.56	0.937	-149.1	0.018	-4.2	8.45	82.1	0.674	-75
15	0.938	-151.9	0.018	-7.3	7.8	78.3	0.69	-80
20	0.945	-158.6	0.016	-16	5.5	67.8	0.725	-94.7
25	0.95	-162.7	0.015	-20.9	4.3	60	0.77	-107.3
27.12	0.954	-164.2	0.014	-22.4	3.97	57.3	0.782	-111.4
30	0.959	-165.2	0.013	-24.6	3.3	54	0.798	-117.2
35	0.96	-168	0.011	-26.8	2.76	48.8	0.83	-125.3
40	0.962	-169.7	0.009	-26.3	2.19	44.5	0.856	-132.5
45	0.965	-171.4	0.008	-24.4	1.88	41.4	0.87	-137.9
50	0.969	-172.2	0.007	-19.6	1.55	38	0.89	-143.4
60	0.971	-174.3	0.005	-2	1.19	33	0.909	-151
70	0.972	-175.8	0.005	26.3	0.93	28.7	0.92	-159
80	0.9724	-177.4	0.006	45.8	0.746	25.4	0.935	-165
90	0.972	-178.3	0.008	54.1	0.68	26.8	0.901	-167.24
100	0.972	-179.3	0.009	60	0.585	20	0.939	-172.3
105	0.973	-179.7	0.01	61.5	0.5	19.7	0.94	-174.6
110	0.971	179.7	0.011	64.3	0.468	17.1	0.939	-176.76

Table 2
 S Parameters
 $V_{DS} = 100V$ $I_{BIAS} = 0.6A$

Freq. (MHz)	Mag. S11 Phase S11		Mag. S12 Phase S12		Mag. S21 Phase S21		Mag. S22 Phase S22	
2	1	-67.8	0.01	61.9	62.5	151	0.79	-15
5	0.924	-117	0.015	26.6	36.5	114	0.57	-53
10	0.91	-145.7	0.016	5.3	19.7	91	0.51	-76
13.56	0.916	-154	0.015	-2.2	14.3	81.6	0.53	-88
15	0.92	-157	0.015	-4.6	12.9	78.1	0.54	-92
20	0.927	-161	0.014	-11	9.3	68.7	0.59	-105
25	0.933	-165	0.012	-15	6.9	61.2	0.62	-115.6
27.12	0.935	-166	0.011	-15.5	6.3	58.4	0.65	-118
30	0.939	-167.5	0.011	-17.4	5.4	55.2	0.702	-123
35	0.945	-169.5	0.01	-19	4.3	50	0.74	-130
40	0.95	-171	0.008	-17.6	3.6	45.6	0.78	-136
45	0.955	-172.3	0.008	-13	3	42.1	0.805	-141
50	0.96	-173.4	0.006	-9	2.5	38.6	0.825	-146
60	0.964	-175.4	0.0057	8	1.94	33.1	0.86	-154
70	0.967	-177	0.005	31	1.49	28.6	0.885	-160.5
80	0.97	-178.3	0.006	47	1.19	25.3	0.897	-166.5
90	0.972	-178.5	0.008	56	1.05	27.8	0.865	-169.7
100	0.971	-179.5	0.01	61	0.903	19.7	0.905	-173.7
105	0.972	-179.9	0.01	62	0.82	18	0.912	-175.8
110	0.972	179.5	0.011	64	0.78	16.7	0.912	-177.8

Table 3
 S Parameters
 $V_{DS} = 125V$ $I_{BIAS} = 0.5A$

Freq. (MHz)	Mag. S11 Phase S11		Mag. S12 Phase S12		Mag. S21 Phase S21		Mag. S22 Phase S22	
2	1	-60	0.009	64	55	153	0.825	-9.5
5	0.935	-112	0.015	29	34	116	0.618	-43
10	0.922	-142	0.016	6.5	18.7	92	0.54	-66
13.56	0.925	-151	0.016	-1.4	13.7	83	0.55	-79
15	0.927	-155	0.015	-3.7	12.5	79.6	0.56	-83
20	0.933	-160	0.014	-11.2	9	70.1	0.61	-97
25	0.939	-164	0.0128	-15.1	6.7	62.4	0.67	-107
27.12	0.942	-165.8	0.0123	-16.3	6	59.8	0.68	-111
30	0.944	-167	0.0116	-17.5	5.3	56.5	0.72	-116
35	0.95	-169	0.01	-18	4.2	51.3	0.76	-124
40	0.955	-171	0.0089	-17.8	3.3	47	0.79	-130
45	0.959	-172	0.008	-15	2.8	43.4	0.81	-136
50	0.961	-173.2	0.007	-11	2.4	39	0.83	-141
60	0.967	-175	0.0055	6	1.8	34.5	0.86	-150
70	0.97	-177	0.0055	31	1.4	29.6	0.88	-157
80	0.971	-178.3	0.0064	44.5	1.1	26.3	0.9	-164
90	0.972	-179.6	0.0084	56	1.04	28.5	0.86	-165
100	0.972	-179.4	0.0095	61	0.88	20.6	0.908	-171
105	0.97	-179.9	0.01	61.7	0.8	19	0.91	-173
110	0.97	179	0.011	64	0.74	17.5	0.91	-175

Fig. 8 Package Dimensions

TO-247 AD Outline

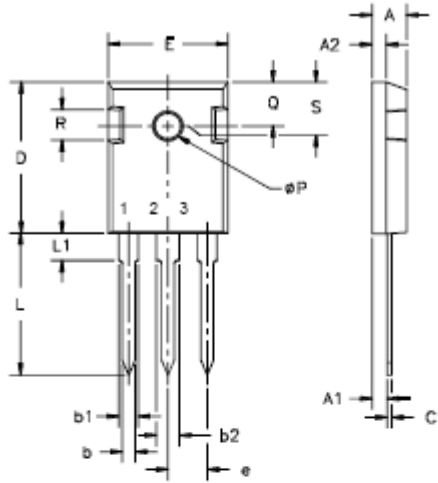

Pin	IXZH10N50L2A	IXZH10N50L2B
1	Gate	Drain
2	Source	Source
3	Drain	Gate
Tab	Source	Source

Dim.	Millimeter		Inches	
	Min.	Max.	Min.	Max.
A	4.7	5.3	.185	.209
A ₁	2.2	2.54	.087	.102
A ₂	2.2	2.6	.059	.098
b	1.0	1.4	.040	.055
b ₁	1.65	2.13	.065	.084
b ₂	2.87	3.12	.113	.123
C	.4	.8	.016	.031
D	20.80	21.46	.819	.845
E	15.75	16.26	.610	.640
e	5.20	5.72	0.205	0.225
L	19.81	20.32	.780	.800
L1		4.50		.177
ØP	3.55	3.65	.140	.144
Q	5.89	6.40	0.232	0.252
R	4.32	5.49	.170	.216
S	6.15	BSC	242	BSC

Doc #dsIXZH10N50L2A/B REV 9/16
© 2016 IXYS RF