

ITEM NO.	PART NUMBER	DESCRIPTION	QTY.	COMPONENT NOTES
1	50-00979	Connector, 3 pin M12 A-code socket, 12xL22mm, gold plated, molding style, solder cup, IP67, shielded	1	
2	30-01570	Wire, 3C TS, 22 AWG, UL20387, 300V, 105C, 60C oil, UV, 5.6 mm, shielded, VW-1, PVC, 80A, black	1	
3	24-00349	Overmold, M12 plug and jack, 180°	1	PVC, black
4	Heat shrink	Heat shrink, black	1	covers drain
5	Heat shrink	Heat shrink, black	1	covers end of jacket

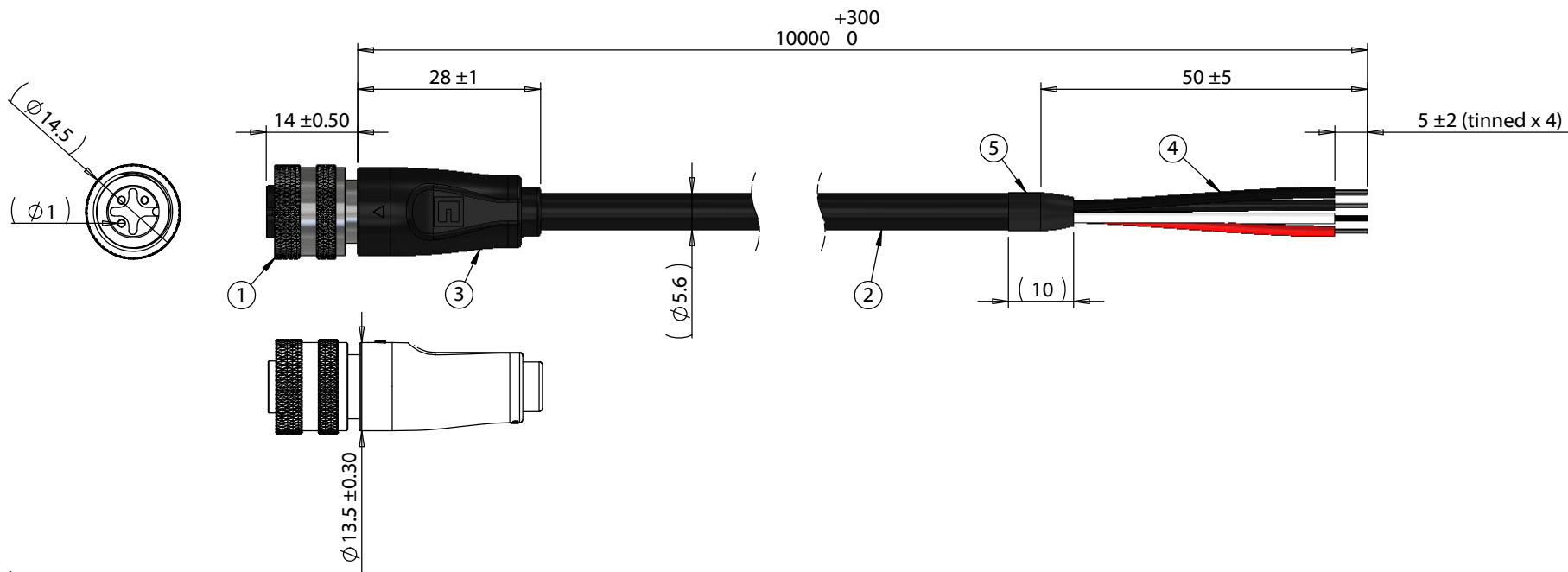

Notes:
 Cable rated for 250 V, 4 A
 Temperature: -40 ~ 105 °C
 Oil resistant up to 60 °C
 Water resistant up to 75 °C
 UV resistant

IP67 waterproof rating when mated with corresponding (IP67) connector

Functionally equivalent components may be substituted

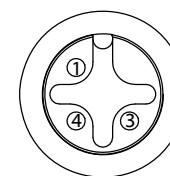

Front View
Not to Scale

Wiring Diagram	
50-00979	wire color
1	red
3	black
4	white
Shell	shield/drain

Revision:	Date:	Description:	Prepared:	Notes:	<h1>TENSILITY</h1> <p>tel 1.541.323.3228 800 877.670.7118 fax 1.541.323.4202 web tensility.com</p>
A	10/15/2020	Initial release	AG Digitally signed by AG Date: 2020.10.15 14:39:09 -07'00'	RoHS compliant	
			Verified:	Function test: no open, no short circuit, no intermittent	Size: Part number: A 10-03804
			AW Digitally signed by AW Date: 2020.10.20 14:27:36 -07'00'	Description:	
			Dimensions are in millimeters. Tolerances: X: ± 0.5 mm X.X: ± 0.3 mm X.XX: ± 0.05 mm	Cable, 10000 mm, 1.0 mm 3C 50-00979 M12 socket to 5 mm tinned, 22 AWG, 30-01570 wire, shielded	Scale: 1:1
					Sheet 1 of 1

5

4

3

2

1