

## DS26C32AMQML Quad Differential Line Receiver

 Check for Samples: [DS26C32AMQML](#)

### FEATURES

- CMOS Design for Low Power
- $\pm 0.2V$  Sensitivity Over Input Common Mode Voltage Range
- Input Fail-Safe Circuitry
- Inputs Won't Load Line When  $V_{CC} = 0V$
- Meets the Requirements of EIA Standard RS-422
- TRI-STATE Outputs for Connection to System Buses

### DESCRIPTION

The DS26C32A is a quad differential line receiver designed to meet the RS-422, RS-423, and Federal Standards 1020 and 1030 for balanced and unbalanced digital data transmission, while retaining the low power characteristics of CMOS.

The DS26C32A has an input sensitivity of 200 mV over the common mode input voltage range of  $\pm 7V$ . The DS26C32A features internal pull-up and pull-down resistors which prevent output oscillation on unused channels.

The DS26C32A provides an enable and disable function common to all four receivers, and features TRI-STATE outputs with 6 mA source and sink capability. This product is pin compatible with the DS26LS32A and the AM26LS32.

### CONNECTION DIAGRAMS

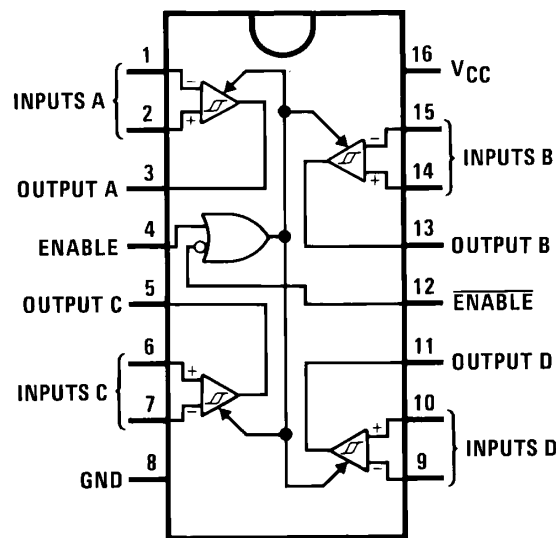

Figure 1. CDIP and CLGA Packages-Top View  
See Package Numbers NFE0016A, NAC0016A, or NAD0016A



Please be aware that an important notice concerning availability, standard warranty, and use in critical applications of Texas Instruments semiconductor products and disclaimers thereto appears at the end of this data sheet.

All trademarks are the property of their respective owners.

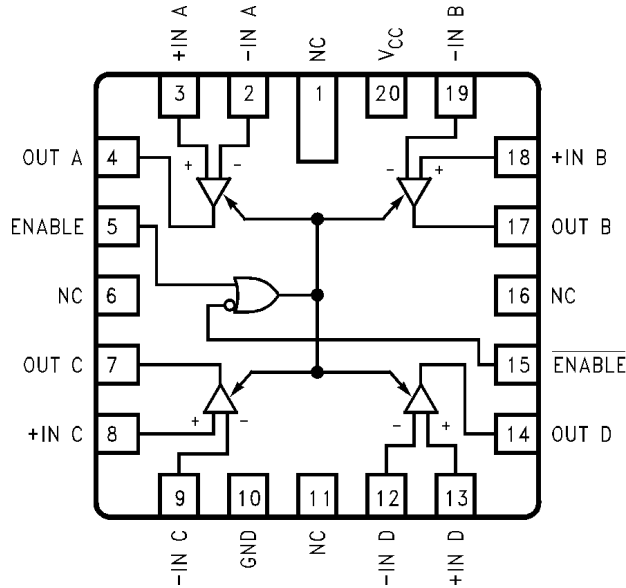
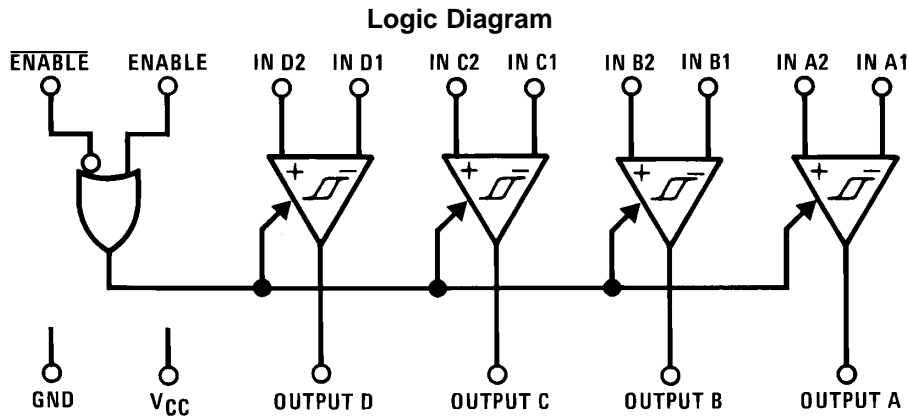

Figure 2. 20-Lead LCCC Package-Top View  
See Package Number NAJ0020A



Truth Table <sup>(1)</sup>

ENABLE	$\overline{\text{ENABLE}}$	Input	Output
L	H	X	Z
All Other Combinations of Enable Inputs		$V_{ID} \geq V_{Th} (\text{Max})$	H
		$V_{ID} \leq V_{Th} (\text{Min})$	L
		Open	H

(1) Z = TRI-STATE



These devices have limited built-in ESD protection. The leads should be shorted together or the device placed in conductive foam during storage or handling to prevent electrostatic damage to the MOS gates.

**Absolute Maximum Ratings<sup>(1)(2)</sup>**

Supply Voltage ( $V_{CC}$ )	7V
Common Mode Range ( $V_{CM}$ )	$\pm 14V$
Differential Input Voltage ( $V_{Diff}$ )	$\pm 14V$
Enable Input Voltage ( $V_I$ )	7V
Storage Temperature Range ( $T_{stg}$ )	$-65^{\circ}C \leq T_A \leq +150^{\circ}C$
Lead Temperature (Soldering 4 sec.)	260°C

- (1) Absolute Maximum Ratings indicate limits beyond which damage to the device may occur. Operating Ratings indicate conditions for which the device is functional, but do not verify specific performance limits. For verified specifications and test conditions, see the Electrical Characteristics. The verified specifications apply only for the test conditions listed. Some performance characteristics may degrade when the device is not operated under the listed test conditions.
- (2) Unless otherwise specified, all voltages are referenced to ground.

**Recommended Operating Conditions**

	Min	Max	Units
Supply Voltage ( $V_{CC}$ )	4.50	5.50	V
Operating Temperature Range ( $T_A$ )	-55	+125	°C

**Quality Conformance Inspection**
**Table 1. Mil-Std-883, Method 5005 - Group A**

Subgroup	Description	Temp °C
1	Static tests at	+25
2	Static tests at	+125
3	Static tests at	-55
4	Dynamic tests at	+25
5	Dynamic tests at	+125
6	Dynamic tests at	-55
7	Functional tests at	+25
8A	Functional tests at	+125
8B	Functional tests at	-55
9	Switching tests at	+25
10	Switching tests at	+125
11	Switching tests at	-55
12	Settling time at	+25
13	Settling time at	+125
14	Settling time at	-55

**DS26C32AM Electrical Characteristics DC Parameters**

Parameter		Test Conditions	Notes	Min	Max	Unit	Sub-groups
$V_{TH}$	Minimum Differential Input Voltage	$V_{CC} = 5V, V_O = V_{OH}$ or $V_{OL}$ , $-7 < V_{CM} < +7$		-200	+200	mV	1, 2, 3
$R_I$	Input Resistance	$V_{CC} = 5V, -7 < V_{CM} < +7$ , One input AC Gnd		4.5	11	K $\Omega$	1, 2, 3
$I_I$	Input Current	$V_{CC} = 5V, V_I = +10V$ , Other Input = Gnd			+1.8	mA	1, 2, 3
		$V_{CC} = 5V, V_I = -10V$ , Other Input = Gnd			-2.7	mA	1, 2, 3
$V_{OH}$	Logical "1" Output Voltage	$V_{CC} = 4.5V, V_{Diff} = +1V$ , $I_O = -6.0mA$		3.8		V	1, 2, 3
$V_{OL}$	Logical "0" Output Voltage	$V_{CC} = 5.5V, V_{CC} = Max$ , $V_{Diff} = -1V, I_O = 6.0mA$			0.3	V	1, 2, 3

**DS26C32AM Electrical Characteristics DC Parameters (continued)**

Parameter		Test Conditions	Notes	Min	Max	Unit	Sub-groups
V <sub>IH</sub>	Minimum Enable High Level Voltage		(1)	2.0		V	1, 2, 3
V <sub>IL</sub>	Maximum Enable Low Level Voltage		(1)		0.8	V	1, 2, 3
I <sub>OZ</sub>	Maximum TRI-STATE Output Leakage Current	V <sub>O</sub> = V <sub>CC</sub> or Gnd, $\overline{\text{Enable}} = V_{IL}$ , Enable = V <sub>IH</sub>			±5.0	μA	1, 2, 3
I <sub>I</sub>	Maximum Enable Input Current	V <sub>I</sub> = V <sub>CC</sub> or Gnd			±1.0	μA	1, 2, 3
I <sub>CC</sub>	Quiescent Power Supply Current	V <sub>Diff</sub> = +1V, V <sub>CC</sub> = 5.5V			25	mA	1, 2, 3

(1) Parameter tested Go-No-Go only.

**DS26C32AM Electrical Characteristics AC Parameters - Propagation Delay Time**

The following conditions apply, unless otherwise specified. V<sub>CC</sub> = 5V ±10%, C<sub>CL</sub> = 50pF, V<sub>Diff</sub> = 2.5V

Parameter		Test Conditions	Notes	Min	Max	Unit	Sub-groups
t <sub>PLH</sub>	Input to Output Prop Delay	V <sub>CM</sub> = 0V			35	ns	9, 10, 11
t <sub>PHL</sub>	Input to Output Prop Delay	V <sub>CM</sub> = 0V			35	ns	9, 10, 11
t <sub>Rise</sub>	Output Rise Time	V <sub>CM</sub> = 0V			9	ns	9, 10, 11
t <sub>Fall</sub>	Output Fall Time	V <sub>CM</sub> = 0V			9	ns	9, 10, 11
t <sub>PLZ</sub>	Output Disable Time	R <sub>L</sub> = 1000Ω			29	ns	9, 10, 11
t <sub>PZL</sub>	Output Enable Time	R <sub>L</sub> = 1000Ω			29	ns	9, 10, 11
t <sub>PHZ</sub>	Output Disable Time	R <sub>L</sub> = 1000Ω			29	ns	9, 10, 11
t <sub>PZH</sub>	Output Enable Time	R <sub>L</sub> = 1000Ω			29	ns	9, 10, 11

### Typical Performance Characteristics

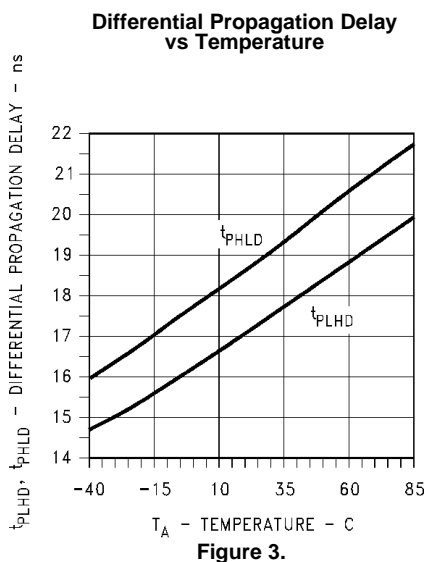

Figure 3.

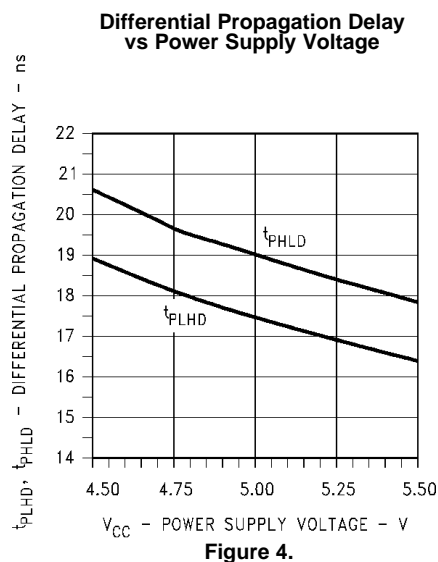

Figure 4.

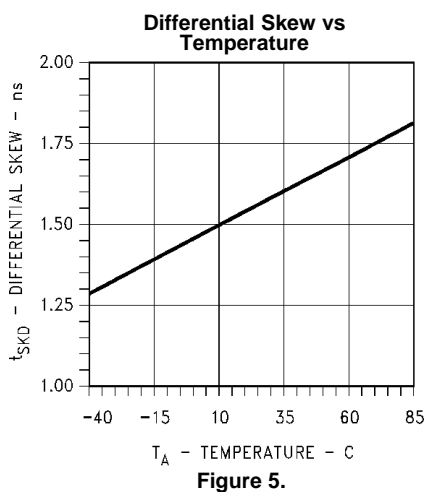

Figure 5.

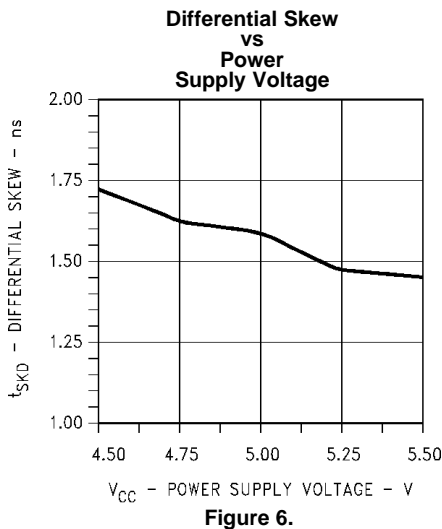

Figure 6.

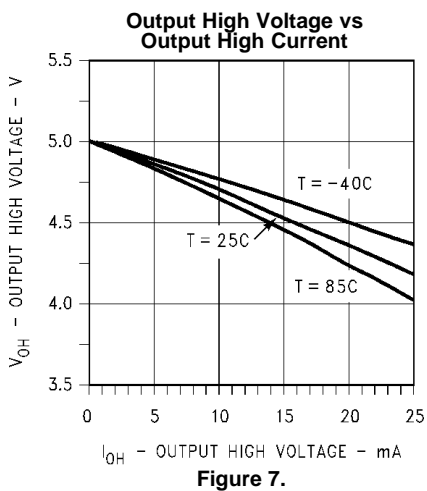

Figure 7.

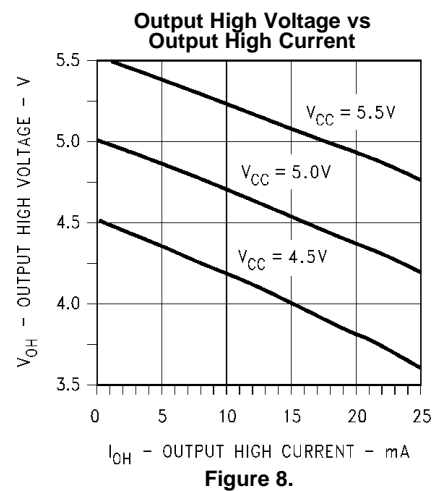
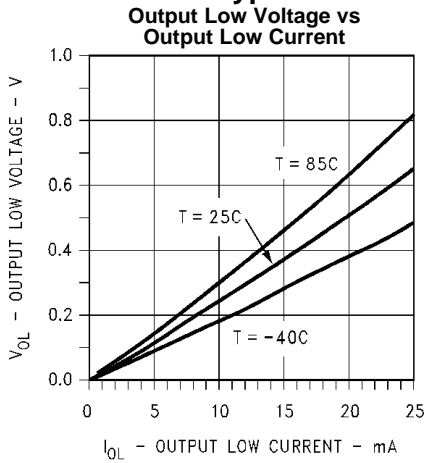
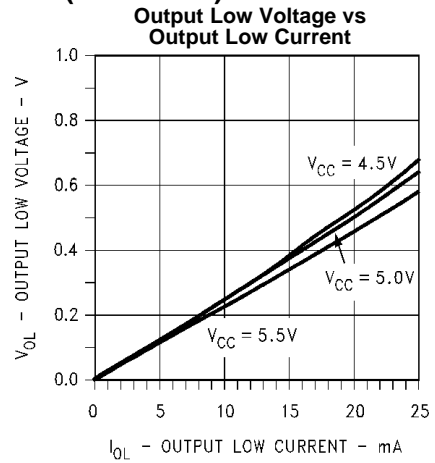

Figure 8.

**Typical Performance Characteristics (continued)**



**Figure 9.**



**Figure 10.**

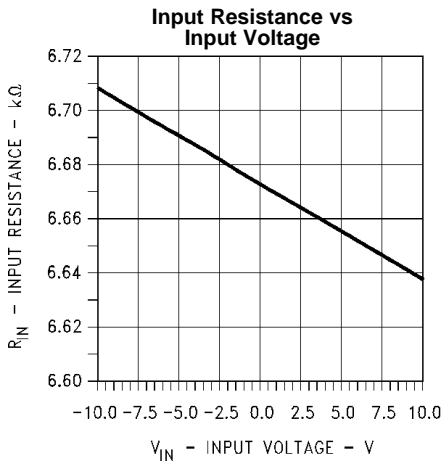

**Figure 11.**

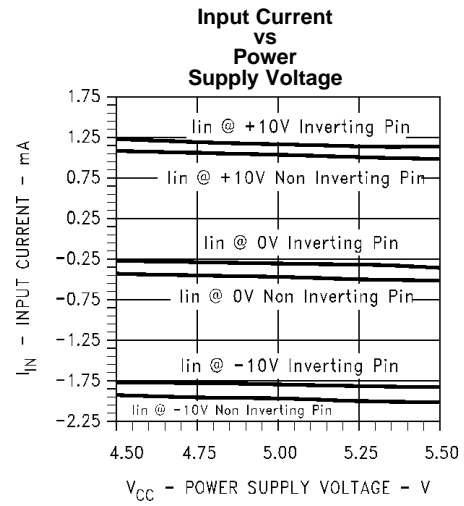

**Figure 12.**

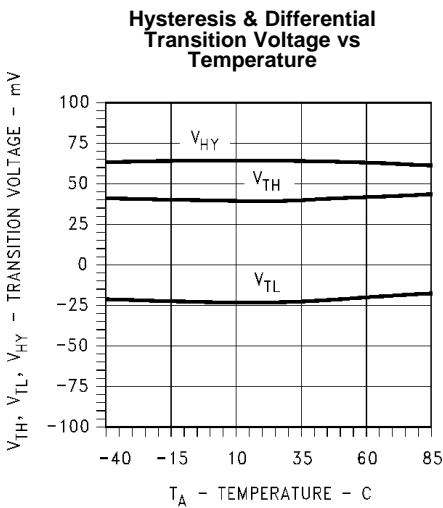

**Figure 13.**

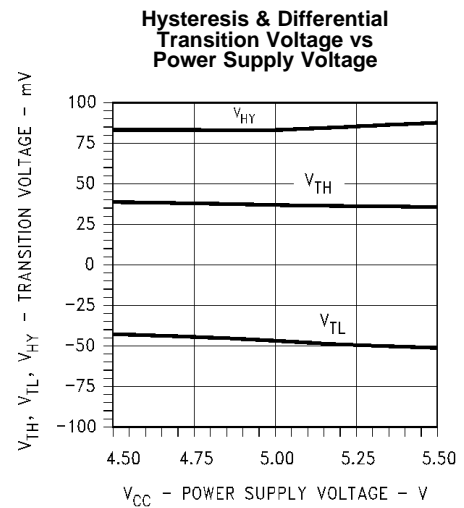

**Figure 14.**

Typical Performance Characteristics (continued)

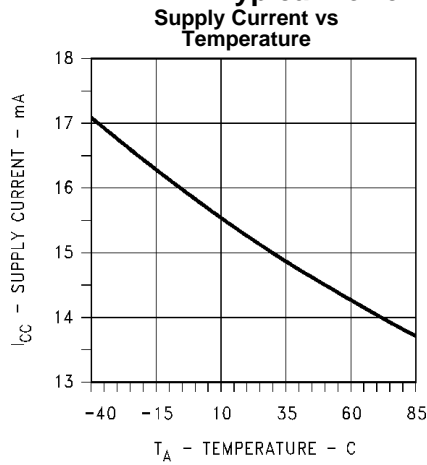

Figure 15.

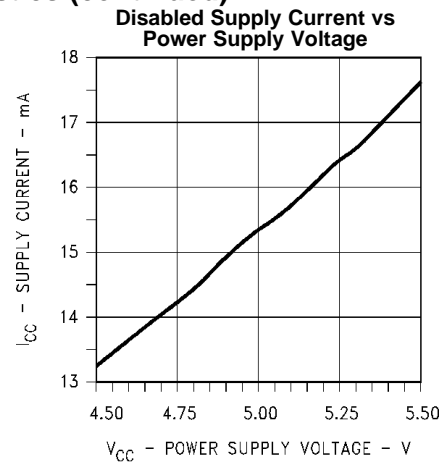

Figure 16.

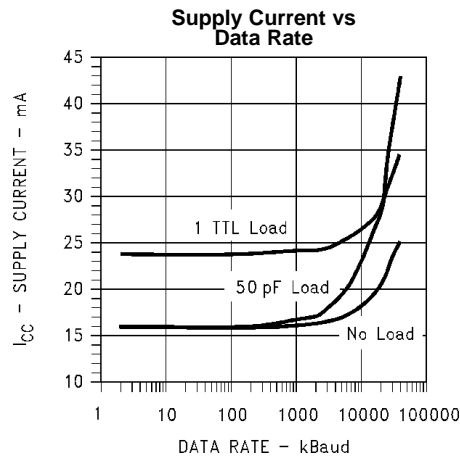
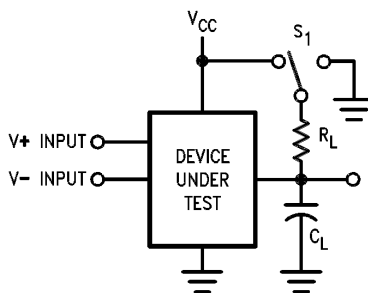

Figure 17.

AC TEST CIRCUIT AND SWITCHING TIME WAVEFORMS



$C_L$  includes load and test jig capacitance.  
 $S_1 = V_{CC}$  for  $t_{PZL}$ , and  $t_{PLZ}$  measurements.  
 $S_1 = Gnd$  for  $t_{PZH}$ , and  $t_{PHZ}$  measurements.

Figure 18. Test Circuit for TRI-STATE Output Tests

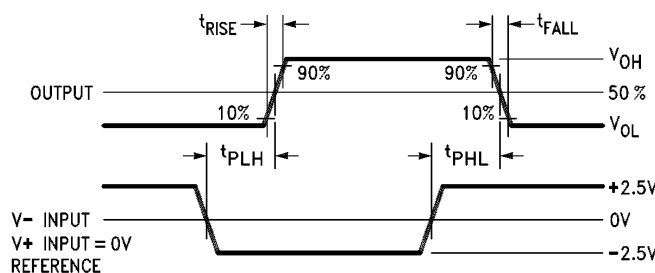

Figure 19. Propagation Delay

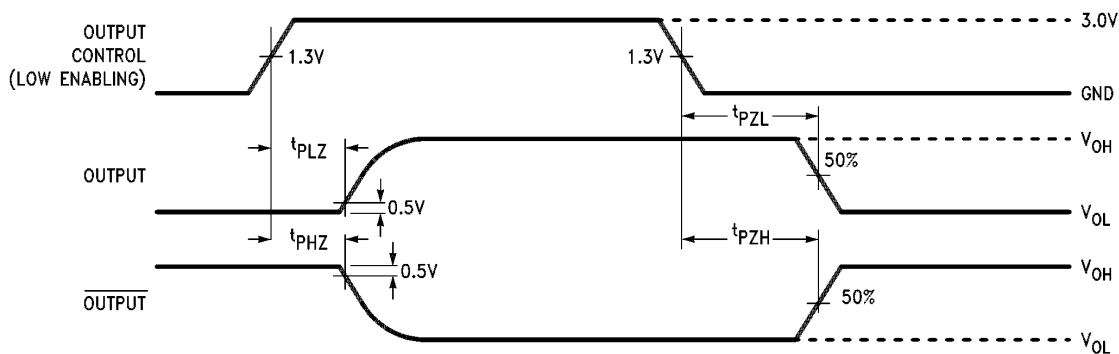
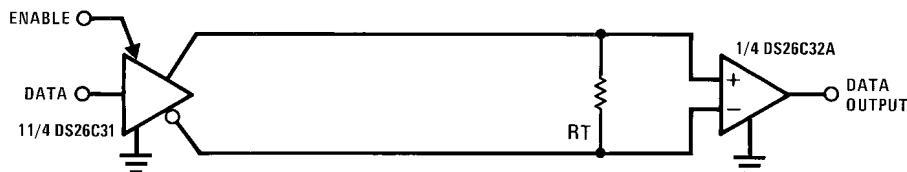

Figure 20. TRI-STATE Output Enable and Disable Waveforms

TYPICAL APPLICATIONS

Figure 21. Two-Wire Balanced Systems, RS-422





**REVISION HISTORY**

<b>Released</b>	<b>Revision</b>	<b>Section</b>	<b>Changes</b>
10/26/2010	*	New Release, Corporate format	MDS data sheets converted into one Corp. data sheet format. MNDS26C32AM-X Rev 0B0 will be archived.
4/15/2013	A		Changed layout of National Data Sheet to TI format

**PACKAGING INFORMATION**

Orderable Device	Status (1)	Package Type	Package Drawing	Pins	Package Qty	Eco Plan (2)	Lead finish/ Ball material (6)	MSL Peak Temp (3)	Op Temp (°C)	Device Marking (4/5)	Samples
5962-9164001M2A	ACTIVE	LCCC	NAJ	20	50	RoHS & Green	Call TI	Level-1-NA-UNLIM	-55 to 125	DS26C32AME /883 Q 5962-91640 01M2A ACO 01M2A >T	<a href="#">Samples</a>
5962-9164001MEA	ACTIVE	CDIP	NFE	16	25	Non-RoHS & Green	Call TI	Level-1-NA-UNLIM	-55 to 125	DS26C32AMJ/883 5962-9164001MEA Q	<a href="#">Samples</a>
5962-9164001MFA	ACTIVE	CFP	NAD	16	19	Non-RoHS & Green	Call TI	Level-1-NA-UNLIM	-55 to 125	DS26C32AMW /883 Q 5962-91640 01MFA ACO 01MFA >T	<a href="#">Samples</a>
5962-9164001MXA	ACTIVE	CFP	NAC	16	42	Non-RoHS & Green	Call TI	Level-1-NA-UNLIM	-55 to 125	DS26C32AMWG /883 Q 5962-91640 01MXA ACO 01MXA >T	<a href="#">Samples</a>
DS26C32A MD8	ACTIVE	DIESALE	Y	0	100	RoHS & Green	Call TI	Level-1-NA-UNLIM	-55 to 125		<a href="#">Samples</a>
DS26C32AME/883	ACTIVE	LCCC	NAJ	20	50	RoHS & Green	Call TI	Level-1-NA-UNLIM	-55 to 125	DS26C32AME /883 Q 5962-91640 01M2A ACO 01M2A >T	<a href="#">Samples</a>
DS26C32AMJ/883	ACTIVE	CDIP	NFE	16	25	Non-RoHS & Green	Call TI	Level-1-NA-UNLIM	-55 to 125	DS26C32AMJ/883 5962-9164001MEA Q	<a href="#">Samples</a>
DS26C32AMW/883	ACTIVE	CFP	NAD	16	19	Non-RoHS & Green	Call TI	Level-1-NA-UNLIM	-55 to 125	DS26C32AMW /883 Q 5962-91640 01MFA ACO 01MFA >T	<a href="#">Samples</a>
DS26C32AMWG/883	ACTIVE	CFP	NAC	16	42	Non-RoHS & Green	Call TI	Level-1-NA-UNLIM	-55 to 125	DS26C32AMWG /883 Q 5962-91640 01MXA ACO 01MXA >T	<a href="#">Samples</a>

(1) The marketing status values are defined as follows:

**ACTIVE:** Product device recommended for new designs.

**LIFEBUY:** TI has announced that the device will be discontinued, and a lifetime-buy period is in effect.

**NRND:** Not recommended for new designs. Device is in production to support existing customers, but TI does not recommend using this part in a new design.

**PREVIEW:** Device has been announced but is not in production. Samples may or may not be available.

**OBSELETE:** TI has discontinued the production of the device.

(2) **RoHS:** TI defines "RoHS" to mean semiconductor products that are compliant with the current EU RoHS requirements for all 10 RoHS substances, including the requirement that RoHS substance do not exceed 0.1% by weight in homogeneous materials. Where designed to be soldered at high temperatures, "RoHS" products are suitable for use in specified lead-free processes. TI may reference these types of products as "Pb-Free".

**RoHS Exempt:** TI defines "RoHS Exempt" to mean products that contain lead but are compliant with EU RoHS pursuant to a specific EU RoHS exemption.

**Green:** TI defines "Green" to mean the content of Chlorine (Cl) and Bromine (Br) based flame retardants meet JS709B low halogen requirements of  $\leq 1000$ ppm threshold. Antimony trioxide based flame retardants must also meet the  $\leq 1000$ ppm threshold requirement.

(3) MSL, Peak Temp. - The Moisture Sensitivity Level rating according to the JEDEC industry standard classifications, and peak solder temperature.

(4) There may be additional marking, which relates to the logo, the lot trace code information, or the environmental category on the device.

(5) Multiple Device Markings will be inside parentheses. Only one Device Marking contained in parentheses and separated by a "~" will appear on a device. If a line is indented then it is a continuation of the previous line and the two combined represent the entire Device Marking for that device.

(6) Lead finish/Ball material - Orderable Devices may have multiple material finish options. Finish options are separated by a vertical ruled line. Lead finish/Ball material values may wrap to two lines if the finish value exceeds the maximum column width.

**Important Information and Disclaimer:**The information provided on this page represents TI's knowledge and belief as of the date that it is provided. TI bases its knowledge and belief on information provided by third parties, and makes no representation or warranty as to the accuracy of such information. Efforts are underway to better integrate information from third parties. TI has taken and continues to take reasonable steps to provide representative and accurate information but may not have conducted destructive testing or chemical analysis on incoming materials and chemicals. TI and TI suppliers consider certain information to be proprietary, and thus CAS numbers and other limited information may not be available for release.

In no event shall TI's liability arising out of such information exceed the total purchase price of the TI part(s) at issue in this document sold by TI to Customer on an annual basis.

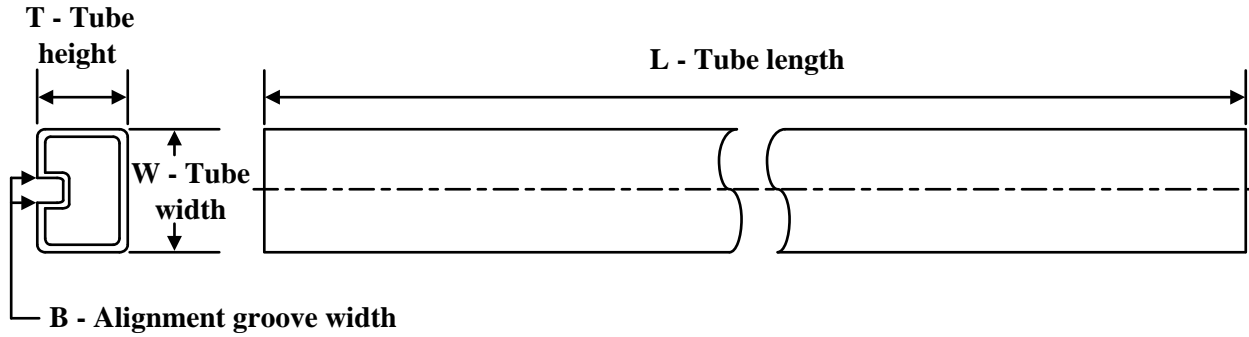
**TUBE**

\*All dimensions are nominal

Device	Package Name	Package Type	Pins	SPQ	L (mm)	W (mm)	T (μm)	B (mm)
5962-9164001M2A	NAJ	LCCC	20	50	470	11	3810	0
5962-9164001MEA	NFE	CDIP	16	25	506.98	15.24	13440	NA
5962-9164001MFA	NAD	CFP	16	19	502	23	9398	9.78
DS26C32AME/883	NAJ	LCCC	20	50	470	11	3810	0
DS26C32AMJ/883	NFE	CDIP	16	25	506.98	15.24	13440	NA
DS26C32AMW/883	NAD	CFP	16	19	502	23	9398	9.78

NAJ0020A

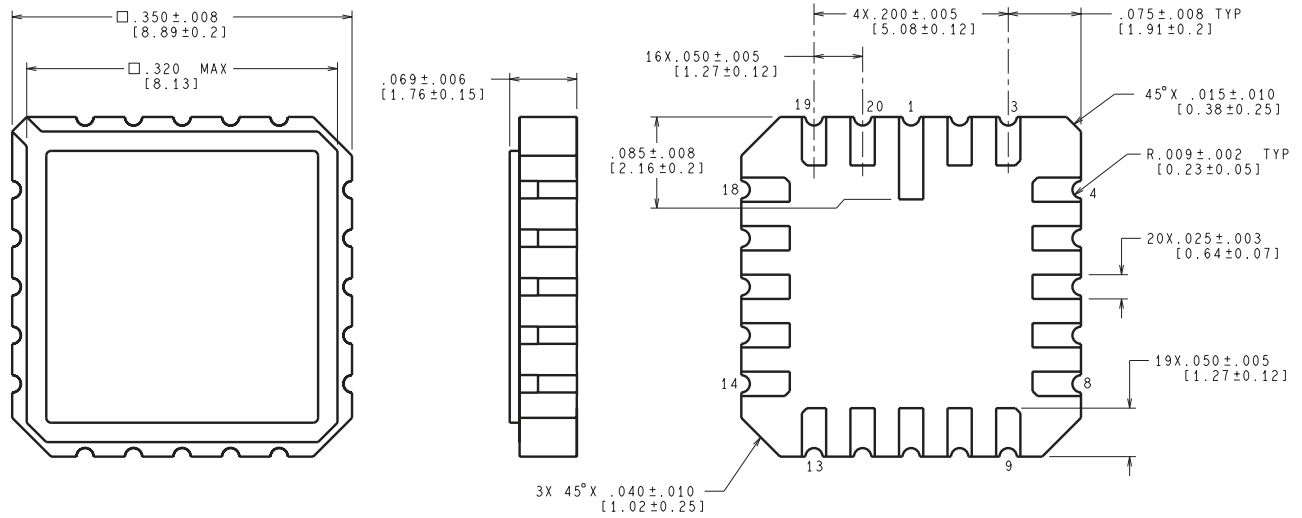

CONTROLLING DIMENSION IS INCH  
 VALUES IN [ ] ARE MILLIMETERS

E20A (Rev F)



# EXAMPLE BOARD LAYOUT

NAC0016A

CFP - 2.33mm max height

CERAMIC FLATPACK

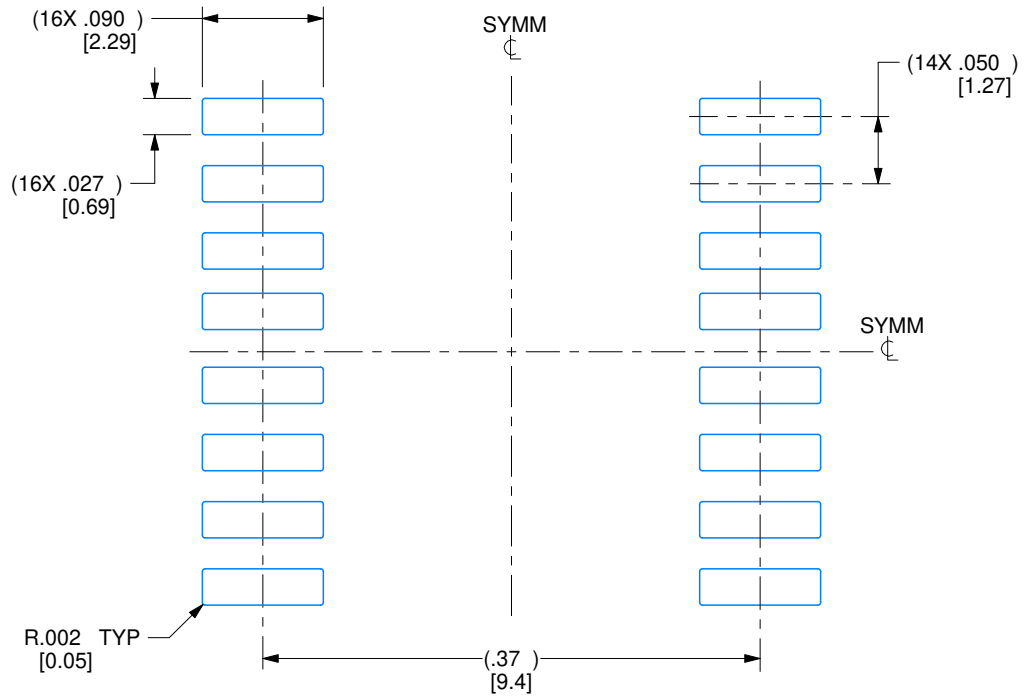

RECOMMENDED LAND PATTERN

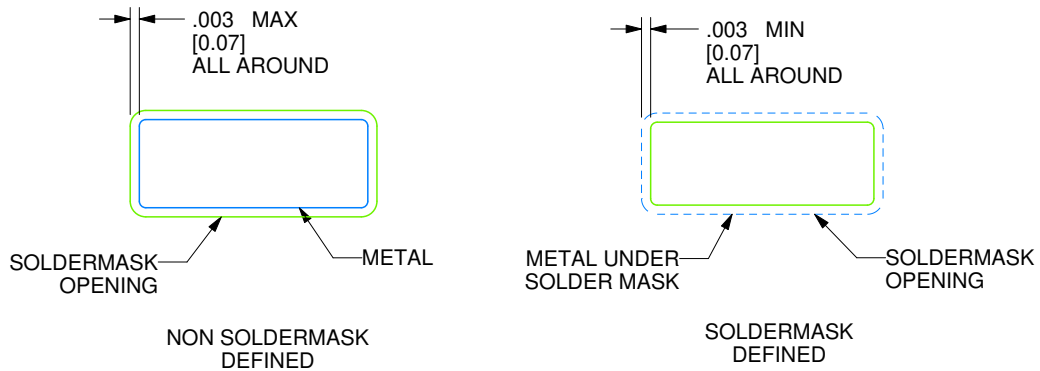

4215198/C 08/2022

# REVISIONS

REV	DESCRIPTION	E.C.N.	DATE	BY/APP'D
A	RELEASE TO DOCUMENT CONTROL	2197879	12/30/2021	TINA TRAN / ANIS FAUZI
B	NO CHANGE TO DRAWING; REVISION FOR YODA RELEASE;	2198832	02/15/2022	K. SINCERBOX
C	.387±.003 WAS .39000±.00012;	2200917	08/08/2022	D. CHIN / K. SINCERBOX



NFE0016A

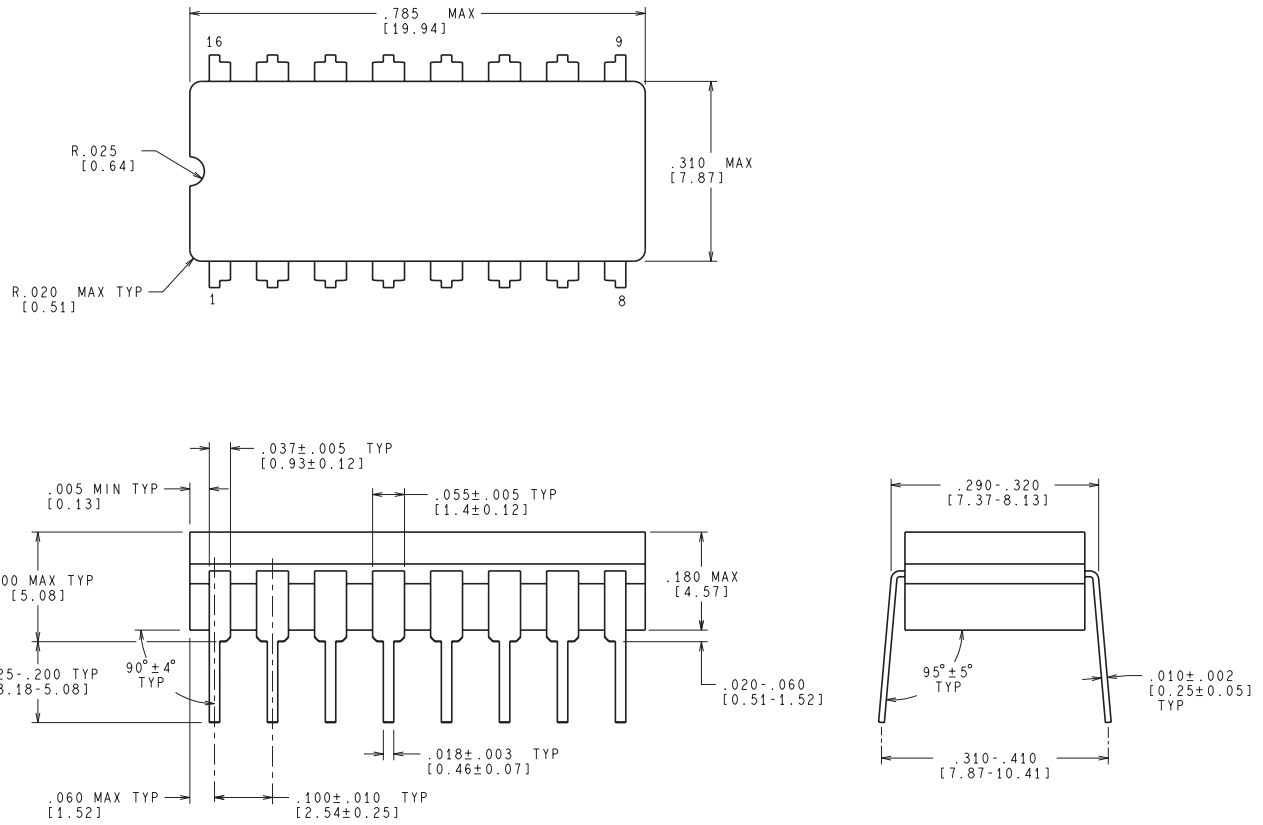

CONTROLLING DIMENSION IS INCH  
VALUES IN [ ] ARE MILLIMETERS

J16A (REV L)

NAD0016A

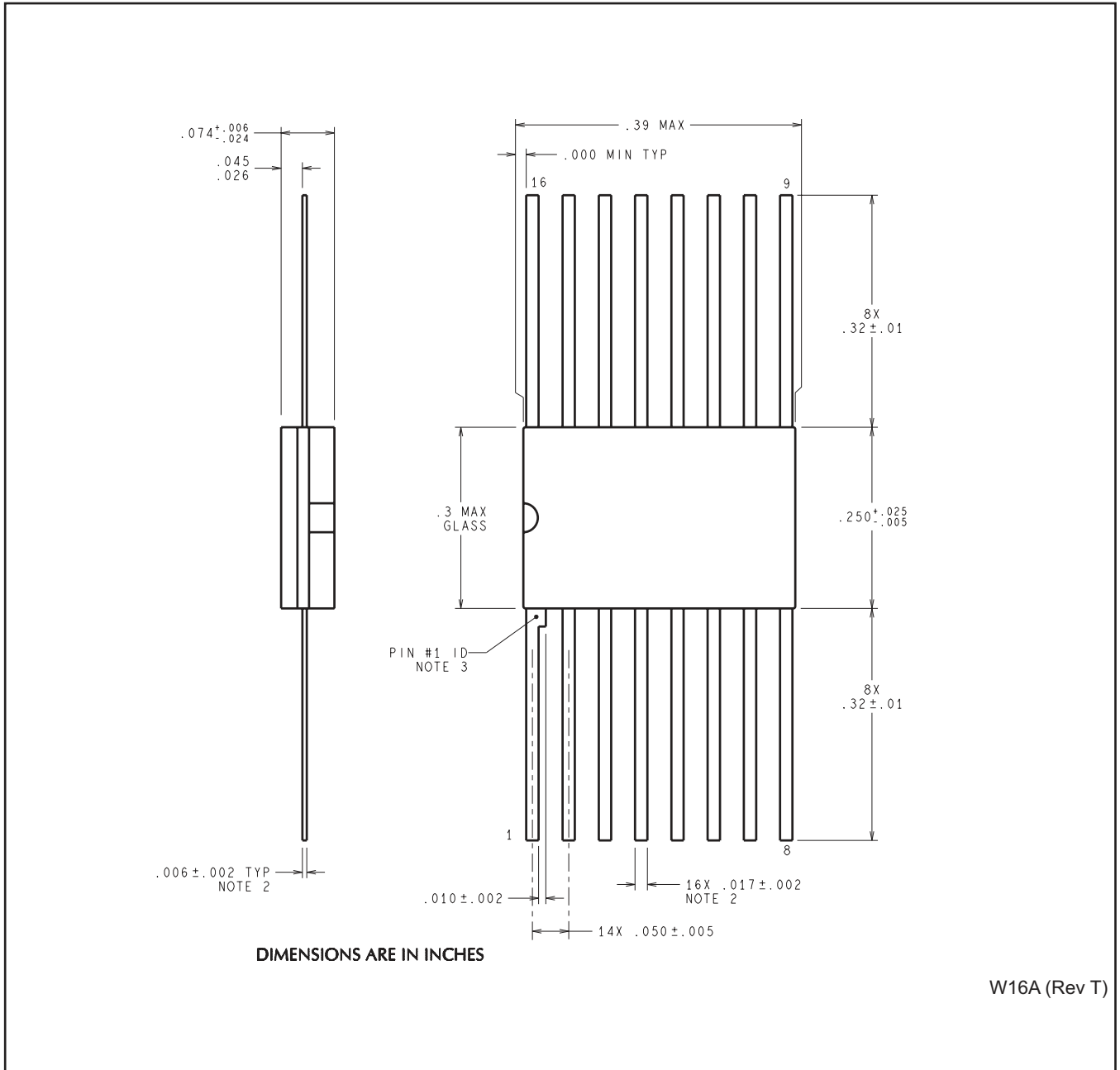

## IMPORTANT NOTICE AND DISCLAIMER

TI PROVIDES TECHNICAL AND RELIABILITY DATA (INCLUDING DATA SHEETS), DESIGN RESOURCES (INCLUDING REFERENCE DESIGNS), APPLICATION OR OTHER DESIGN ADVICE, WEB TOOLS, SAFETY INFORMATION, AND OTHER RESOURCES "AS IS" AND WITH ALL FAULTS, AND DISCLAIMS ALL WARRANTIES, EXPRESS AND IMPLIED, INCLUDING WITHOUT LIMITATION ANY IMPLIED WARRANTIES OF MERCHANTABILITY, FITNESS FOR A PARTICULAR PURPOSE OR NON-INFRINGEMENT OF THIRD PARTY INTELLECTUAL PROPERTY RIGHTS.

These resources are intended for skilled developers designing with TI products. You are solely responsible for (1) selecting the appropriate TI products for your application, (2) designing, validating and testing your application, and (3) ensuring your application meets applicable standards, and any other safety, security, regulatory or other requirements.

These resources are subject to change without notice. TI grants you permission to use these resources only for development of an application that uses the TI products described in the resource. Other reproduction and display of these resources is prohibited. No license is granted to any other TI intellectual property right or to any third party intellectual property right. TI disclaims responsibility for, and you will fully indemnify TI and its representatives against, any claims, damages, costs, losses, and liabilities arising out of your use of these resources.

TI's products are provided subject to [TI's Terms of Sale](#) or other applicable terms available either on [ti.com](https://www.ti.com) or provided in conjunction with such TI products. TI's provision of these resources does not expand or otherwise alter TI's applicable warranties or warranty disclaimers for TI products.

TI objects to and rejects any additional or different terms you may have proposed.

Mailing Address: Texas Instruments, Post Office Box 655303, Dallas, Texas 75265  
Copyright © 2023, Texas Instruments Incorporated