

FEATURES

Internally matched to 50 Ω input and output

Internally biased

Operating frequency: 700 MHz to 1000 MHz

Gain: 20 dB

OIP3: 45 dBm

P1 dB: 27 dBm

Noise figure: 5 dB

3 mm \times 3 mm LFCSP

Power supply: 5 V

APPLICATIONS

CDMA2000, WCDMA, and GSM base station transceivers and high power amplifiers

FUNCTIONAL BLOCK DIAGRAM

Figure 1.

06957-001

GENERAL DESCRIPTION

The **ADL5322** is a high linearity GaAs driver amplifier that is internally matched to 50 Ω for operation in the 700 MHz to 1000 MHz frequency range. The amplifier, which has a gain of 20 dB, is specially designed for use in the output stage of a cellular base station radio or as an input preamplifier in a multicarrier base station power amplifier. Matching and biasing are all on-chip. The **ADL5322** is available in a Pb-free, 3 mm \times 3 mm, 8-lead LFCSP package with an operating temperature from -40°C to $+85^{\circ}\text{C}$.

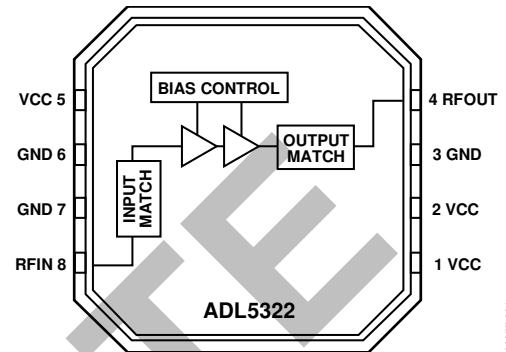
Rev. A

[Document Feedback](#)

Information furnished by Analog Devices is believed to be accurate and reliable. However, no responsibility is assumed by Analog Devices for its use, nor for any infringements of patents or other rights of third parties that may result from its use. Specifications subject to change without notice. No license is granted by implication or otherwise under any patent or patent rights of Analog Devices. Trademarks and registered trademarks are the property of their respective owners.

TABLE OF CONTENTS

Features	1	Pin Configuration and Function Descriptions.....	5
Applications.....	1	Typical Performance Characteristics	6
Functional Block Diagram	1	Basic Connections	8
General Description	1	CDMA2000 Driving Application.....	8
Revision History	2	Evaluation Board	10
Specifications.....	3	Outline Dimensions	11
Absolute Maximum Ratings.....	4	Ordering Guide	11
ESD Caution.....	4		

REVISION HISTORY**1/14—Rev. 0 to Rev. A:**

Changes to Figure 2.....	5
Added Figure 12, Renumbered Sequentially	7
Added Exposed Pad Notation to Outline Dimensions	11
Changes to Ordering Guide	11

7/06—Revision 0: Initial Version

OBSOLETE

SPECIFICATIONS

$V_{CC} = 5\text{ V}$, $T_A = 25^\circ\text{C}$.

Table 1.

Parameter	Test Conditions/Comments	Min	Typ	Max	Unit
FREQUENCY RANGE		700		1000	MHz
GAIN	Frequency = 850 MHz	19	20.3	21.4	dB
vs. Frequency	832 MHz to 870 MHz		± 0.125		dB
vs. Temperature	-40°C to $+85^\circ\text{C}$		± 1		dB
vs. Voltage	5 V, @ 5% (4.75 V to 5.25 V)		± 0.1		dB
vs. Frequency	Frequency = 900 MHz	18.6	19.9	21.1	dB
vs. Temperature	869 MHz to 894 MHz		± 0.125		dB
vs. Temperature	-40°C to $+85^\circ\text{C}$		± 1		dB
vs. Voltage	5 V, @ 5% (4.75 V to 5.25 V)		± 0.1		dB
vs. Frequency	Frequency = 950 MHz	18.3	19.6	20.8	dB
vs. Temperature	925 MHz to 960 MHz		± 0.125		dB
vs. Temperature	-40°C to $+85^\circ\text{C}$		± 1.1		dB
vs. Voltage	5 V, @ 5% (4.75 V to 5.25 V)		± 0.1		dB
P1 dB	Frequency = 850 MHz	27.0	27.7		dBm
vs. Frequency	832 MHz to 870 MHz		± 0.1		dBm
vs. Temperature	-40°C to $+85^\circ\text{C}$		± 1		dBm
vs. Voltage	5 V, @ 5% (4.75 V to 5.25 V)		± 0.3		dBm
vs. Frequency	Frequency = 900 MHz	27.3	27.9		dBm
vs. Frequency	869 MHz to 894 MHz		± 0.1		dBm
vs. Temperature	-40°C to $+85^\circ\text{C}$		± 1		dBm
vs. Voltage	5 V, @ 5% (4.75 V to 5.25 V)		± 0.4		dBm
vs. Frequency	Frequency = 950 MHz	26.7	27.5		dBm
vs. Frequency	925 MHz to 960 MHz		± 0.2		dBm
vs. Temperature	-40°C to $+85^\circ\text{C}$		± 1		dBm
vs. Voltage	5 V, @ 5% (4.75 V to 5.25 V)		± 0.4		dBm
NOISE FIGURE	Frequency = 830 MHz to 960 MHz		5		dB
INPUT RETURN LOSS	Frequency = 830 MHz to 960 MHz		-10		dB
OUTPUT RETURN LOSS	Frequency = 830 MHz to 960 MHz		-10		dB
OIP3	Carrier spacing = 1 MHz, $P_{OUT} = 5\text{ dBm}$ per carrier				
vs. Frequency	Frequency = 850 MHz		44.8		dBm
vs. Frequency	832 MHz to 870 MHz		± 0.25		dBm
vs. Temperature	-40°C to $+85^\circ\text{C}$		± 3.0		dBm
vs. Voltage	5 V, @ 5% (4.75 V to 5.25 V)		± 0.5		dBm
vs. Frequency	Frequency = 900 MHz		45.3		dBm
vs. Frequency	869 MHz to 894 MHz		± 0.25		dBm
vs. Temperature	-40°C to $+85^\circ\text{C}$		± 2.7		dBm
vs. Voltage	5 V, @ 5% (4.75 V to 5.25 V)		± 0.8		dBm
vs. Frequency	Frequency = 950 MHz		44.4		dBm
vs. Frequency	925 MHz to 960 MHz		± 0.25		dBm
vs. Temperature	-40°C to $+85^\circ\text{C}$		± 2.2		dBm
vs. Voltage	5 V, @ 5% (4.75 V to 5.25 V)		± 0.8		dBm
POWER SUPPLY					
Supply Voltage		4.75	5	5.25	V
Supply Current	$P_{OUT} = 5\text{ dBm}$		320		mA
Operating Temperature		-40		+85	$^\circ\text{C}$

ABSOLUTE MAXIMUM RATINGS

Table 2.

Parameter	Rating
Supply Voltage, VPOS	6 V
Input Power (re: 50 Ω)	18 dBm
Equivalent Voltage	1.8 V rms
θ_{JC} (Soldered)	28.5°C/W
Maximum Junction Temperature	150°C
Operating Temperature Range	-40°C to +85°C
Storage Temperature Range	-65°C to +150°C
Soldering Temperature	260°C

Stresses above those listed under Absolute Maximum Ratings may cause permanent damage to the device. This is a stress rating only; functional operation of the device at these or any other conditions above those indicated in the operational section of this specification is not implied. Exposure to absolute maximum rating conditions for extended periods may affect device reliability.

ESD CAUTION



ESD (electrostatic discharge) sensitive device. Charged devices and circuit boards can discharge without detection. Although this product features patented or proprietary protection circuitry, damage may occur on devices subjected to high energy ESD. Therefore, proper ESD precautions should be taken to avoid performance degradation or loss of functionality.

OBSOLETE

PIN CONFIGURATION AND FUNCTION DESCRIPTIONS

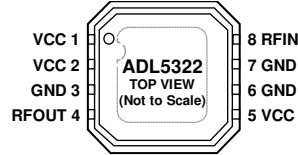

NOTES

- CONNECT THE EXPOSED PADDLE TO THE GROUND PLANE VIA A LOW IMPEDANCE PADDLE.

06057-002

Figure 2. Pin Configuration

Table 3. Pin Function Descriptions

Pin No.	Mnemonic	Description
1, 2, 5	VCC	Positive 5 V Supply Voltage. Bypass these three pins with independent power supply decoupling networks (100 pF, 10 nF, and 10 μ F).
3, 6, 7	GND	Device Ground.
4	RFOUT	RF Output. Internally matched to 50 Ω .
8	RFIN	RF Input. Internally matched to 50 Ω .
N/A	EP	Exposed Paddle. Connect to the ground plane via a low impedance path.

Table 4. S-Parameters

Frequency	ADL5322 (1, 1)	ADL5322 (1, 2)	ADL5322 (2, 1)	ADL5322 (2, 2)
700.0 MHz	0.210/109.457	0.002/97.018	+11.221/–158.622	0.436/150.470
720.0 MHz	0.195/104.437	0.002/93.284	+11.108/–166.579	0.392/145.211
740.0 MHz	0.179/99.101	0.002/87.856	+11.013/–174.596	0.345/137.443
760.0 MHz	0.165/93.363	0.002/86.137	10.931/177.282	0.295/133.051
780.0 MHz	0.151/86.953	0.002/78.668	10.856/169.006	0.242/125.612
800.0 MHz	0.138/79.928	0.002/74.072	10.781/160.613	0.187/116.434
820.0 MHz	0.125/71.950	0.002/68.940	10.698/152.065	0.130/102.897
840.0 MHz	0.114/62.829	0.002/62.269	10.605/143.342	0.079/76.154
860.0 MHz	0.103/52.162	0.002/56.742	10.493/134.489	0.061/18.090
880.0 MHz	0.095/39.531	0.002/56.696	10.361/125.433	+0.098/–26.962
900.0 MHz	0.090/24.952	0.003/43.549	10.210/116.239	+0.153/–46.741
920.0 MHz	0.088/9.188	0.003/37.254	10.033/106.889	+0.211/–58.300
940.0 MHz	+0.090/–7.350	0.003/29.904	9.837/97.326	+0.269/–66.606
960.0 MHz	+0.095/–23.642	0.003/24.334	9.614/87.600	+0.324/–73.265
980.0 MHz	+0.104/–39.131	0.003/16.521	9.364/77.609	+0.376/–78.914
1.000 GHz	+0.115/–53.477	0.003/8.139	9.081/67.342	+0.424/–83.911

TYPICAL PERFORMANCE CHARACTERISTICS

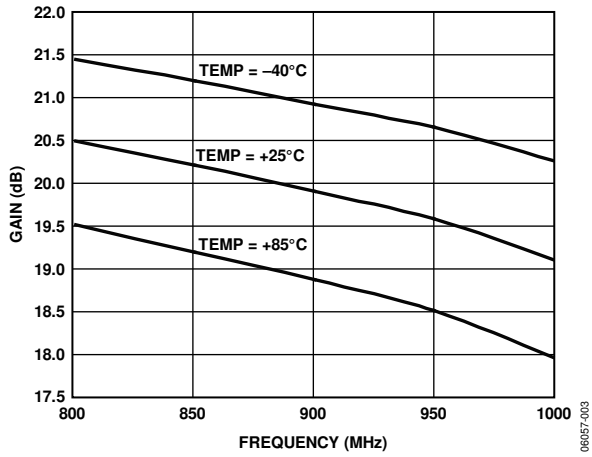

Figure 3. Gain vs. Frequency, $V_{CC} = 5\text{ V}$, $T_A = -40^\circ\text{C}$, $+25^\circ\text{C}$, and $+85^\circ\text{C}$

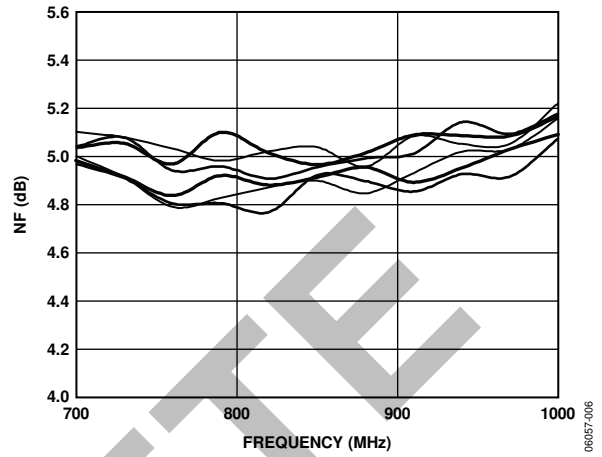

Figure 6. Noise Figure vs. Frequency, Multiple Devices, $V_S = 5\text{ V}$, $T_A = 25^\circ\text{C}$

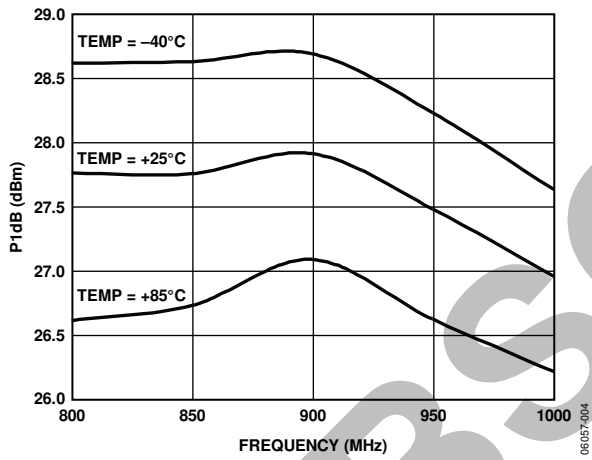

Figure 4. P1 dB vs. Frequency, $V_{CC} = 5\text{ V}$, $T_A = -40^\circ\text{C}$, $+25^\circ\text{C}$, and $+85^\circ\text{C}$

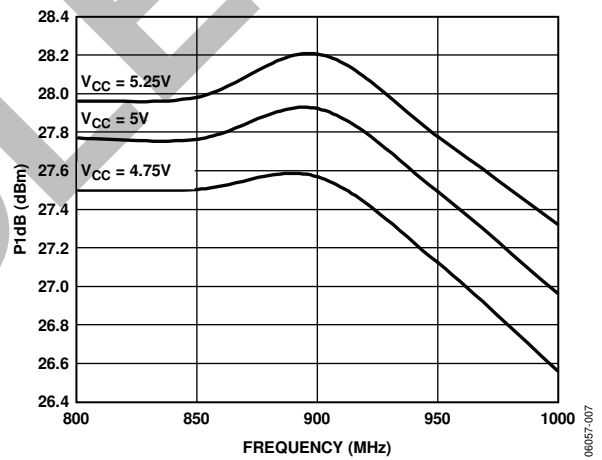

Figure 7. P1 dB vs. Frequency, $V_{CC} = 4.75\text{ V}$, 5 V , and 5.25 V , $T_A = 25^\circ\text{C}$

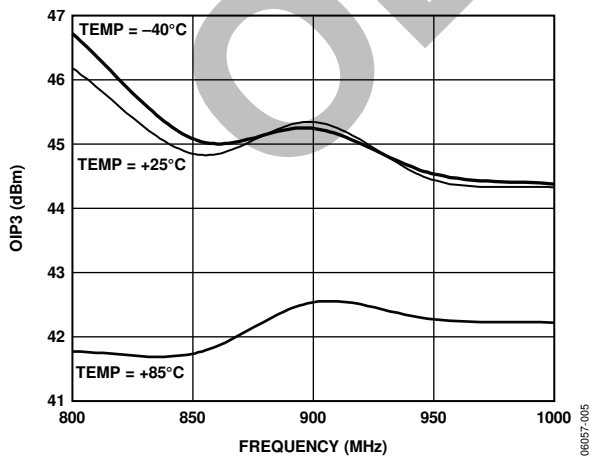

Figure 5. OIP3 vs. Frequency, $V_{CC} = 5\text{ V}$, $T_A = -40^\circ\text{C}$, $+25^\circ\text{C}$, and $+85^\circ\text{C}$

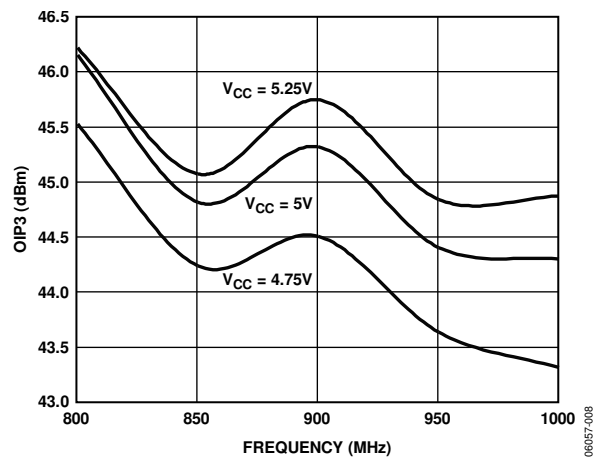

Figure 8. OIP3 vs. Frequency, $V_{CC} = 4.75\text{ V}$, 5 V , and 5.25 V , $T_A = 25^\circ\text{C}$

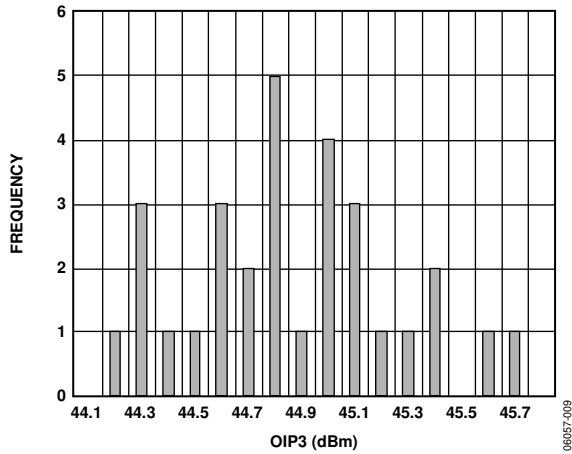

Figure 9. Distribution of OIP3 at 850 MHz

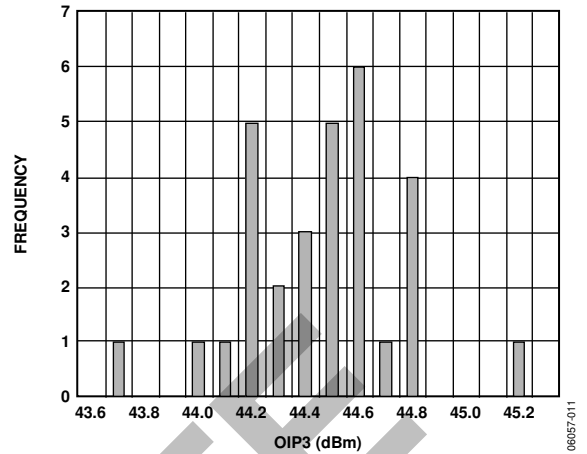

Figure 11. Distribution of OIP3 at 950 MHz

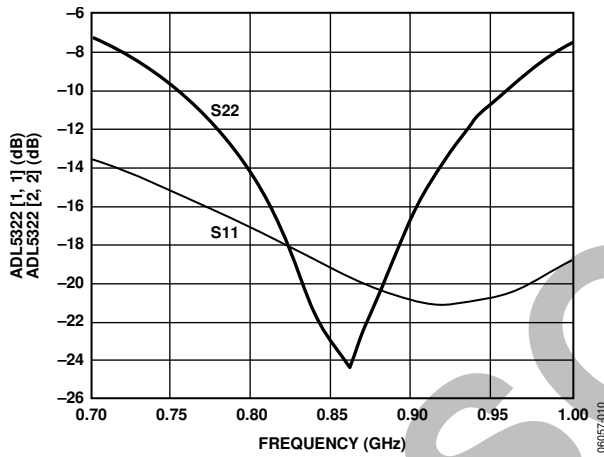

Figure 10. Input S11 and Output S22 Return Loss vs. Frequency

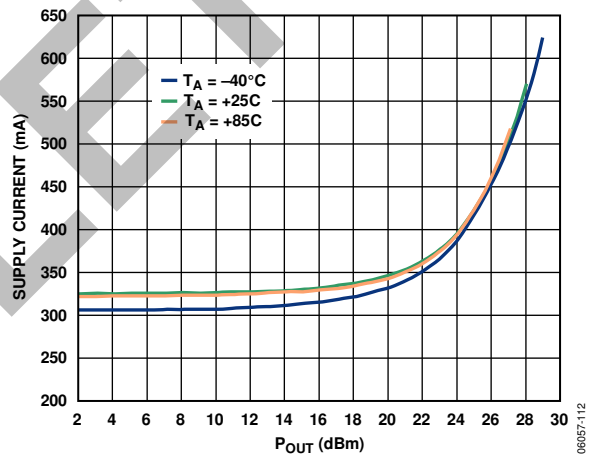

Figure 12. Supply Current vs. P_{OUT} and Temperature $V_{CC} = 5\text{ V}$, $T_A = -40^\circ\text{C}$, $+25^\circ\text{C}$, and $+85^\circ\text{C}$

BASIC CONNECTIONS

Figure 15 shows the basic connections for operating the ADL5322. Each of the three power supply lines should be decoupled with 10 μ F, 10 nF, and 100 pF capacitors. Pin 3, Pin 6, Pin 7, and the exposed paddle under the device should all be connected to a low impedance ground plane. If multiple ground planes are being used, these should be stitched together with vias under the device to optimize thermal conduction. See recommended land pattern in Figure 13.

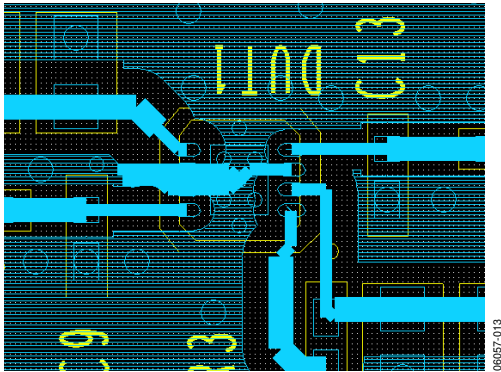

Figure 13. Recommended Land Pattern

CDMA2000 DRIVING APPLICATION

Figure 14 shows a plot of the spectrum of an ADL5322 driving at 4-carrier CDMA2000 signal at 0 dBm per carrier (total carrier power = 6 dBm), centered at 880 MHz. At 750 kHz and 1.98 MHz offset, adjacent channel power ratios of -59 dBc and -84 dBc (measured in 30 kHz with respect to the 1.22 MHz carrier) are observed. At 4 MHz carrier offset, -73 dBc is measured in a 1 MHz bandwidth (-133 dBm/Hz). Note that the spectrum of the four carriers is slightly rounded due to the frequency response of the cavity-tuned filter that was used to filter out the noise and distortion of the source signal.

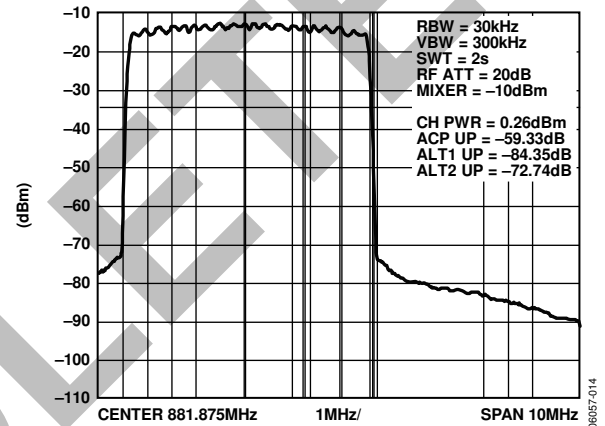

Figure 14. Spectrum of 4 Adjacent CDMA2000 Carriers Centered at 880 MHz; Total Carrier Power = 6 dBm (0 dBm per Carrier)

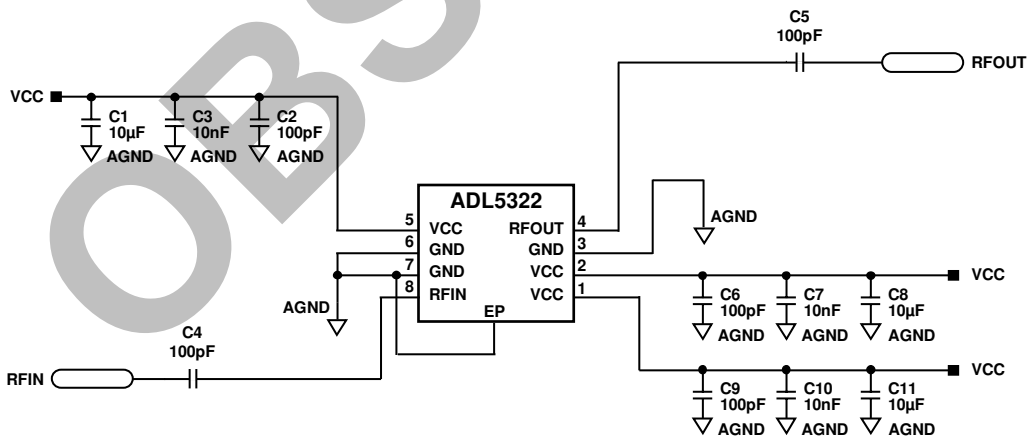

Figure 15. Basic Connections

Figure 16 shows how ACP varies with output power level. The close-in ACP is a function of the signal coding and is unaffected by output headroom at these power levels. The ACP measured at 1.98 MHz carrier offset is -72 dBc at 10 dBm output power (12 dB below the required 60 dBc). At 4 MHz carrier offset, the noise and distortion measured in a 1 MHz bandwidth is -75 dBm at 6 dBm (total) output power (0 dBm per carrier). In a 50 dBm transmitter, this corresponds to an antenna-referred output power of -31 dBm (1 MHz), which is 18 dB below what is required by the CDMA2000 standard.

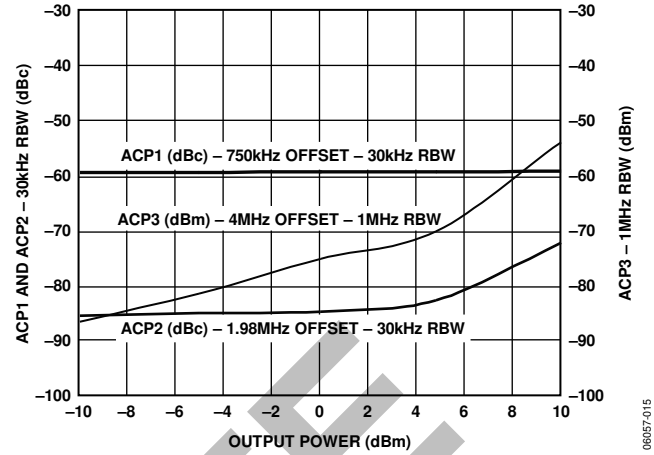

Figure 16. CDMA2000 ACP vs. Output Power per Carrier; 4 Adjacent Carriers

OBSOLETE

EVALUATION BOARD

Figure 18 shows the schematic of the **ADL5322** evaluation board. The board is powered by a single supply in the 4.75 V to 5.25 V range. The power supply is decoupled on each of the three power supply pins by 10 μ F, 10 nF, and 100 pF capacitors. See Table 5 for exact evaluation board component values. Note that all three VCC pins (Pin 1, Pin 2, and Pin 5) should be independently bypassed as shown in Figure 18 for proper operation.

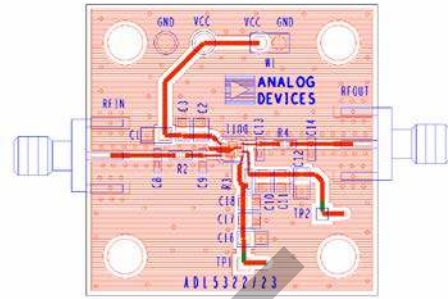

Figure 17. Evaluation Board Component Side View

Table 5. Evaluation Board Components

Component	Function	Default Value
DUT1	Driver amplifier	ADL5322
C1, C12, C16	Low frequency bypass capacitors	10 μ F, 0603
C3, C11, C17	Low frequency bypass capacitors	10 nF, 0402
C2, C10, C18	High frequency bypass capacitors	100 pF, 0402
C8, C9, C13, C14, R3	Open	Open, 0402
R2, R4	AC coupling capacitors	100 pF, 0402

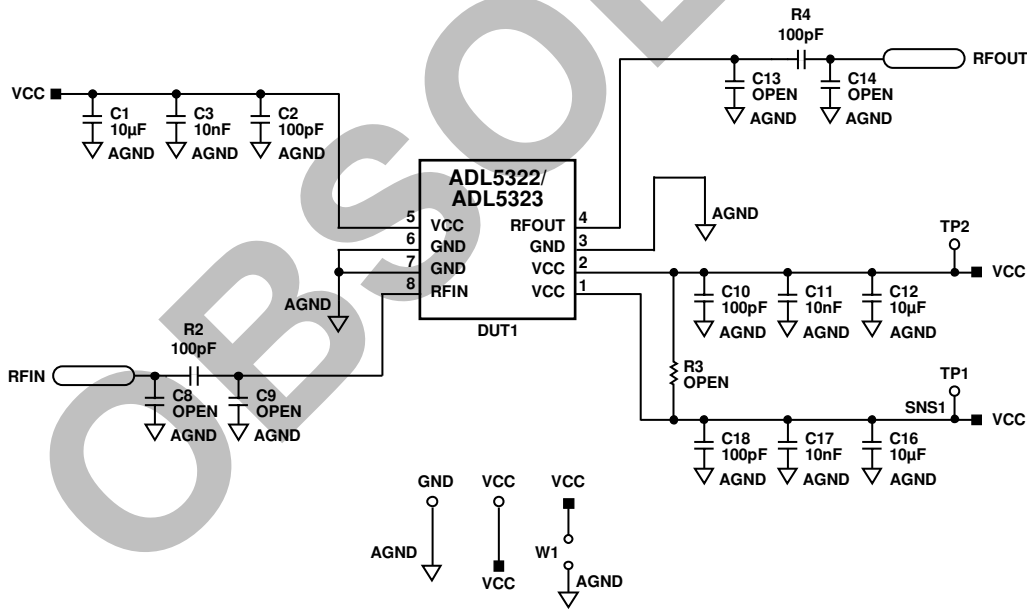

Figure 18. Evaluation Board Schematic

OUTLINE DIMENSIONS

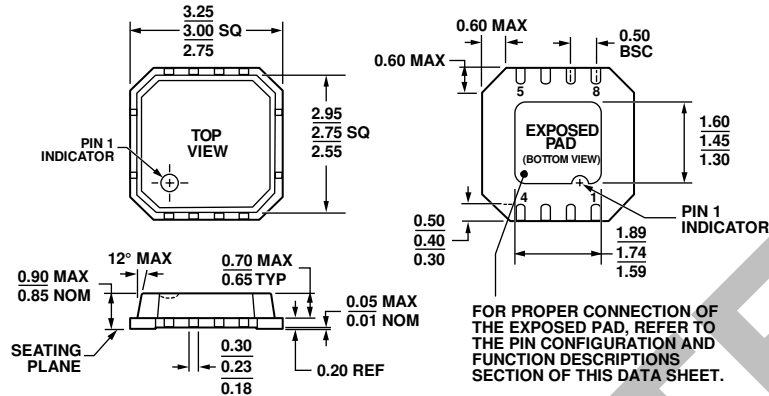

Figure 19. 8-Lead Lead Frame Chip Scale Package [LFCSP_VD]
 3 mm × 3 mm Body, Very Thin, Dual Lead
 (CP-8-2)
 Dimensions shown in millimeters

ORDERING GUIDE

Model ¹	Temperature Range	Package Description	Package Option	Branding	Ordering Quantity
ADL5322ACPZ-R7	-40°C to +85°C	8-Lead LFCSP_VD, 7" Tape and Reel	CP-8-2	OP	1500
ADL5322ACPZ-WP	-40°C to +85°C	8-Lead LFCSP_VD, Waffle Pack	CP-8-2	OP	50
ADL5322-EVALZ		Evaluation Board			1

¹ Z = RoHS Compliant Part.

NOTES

OBSOLETE