

**HV Single
Discrete IGBT
60 Amperes/4500 Volts**

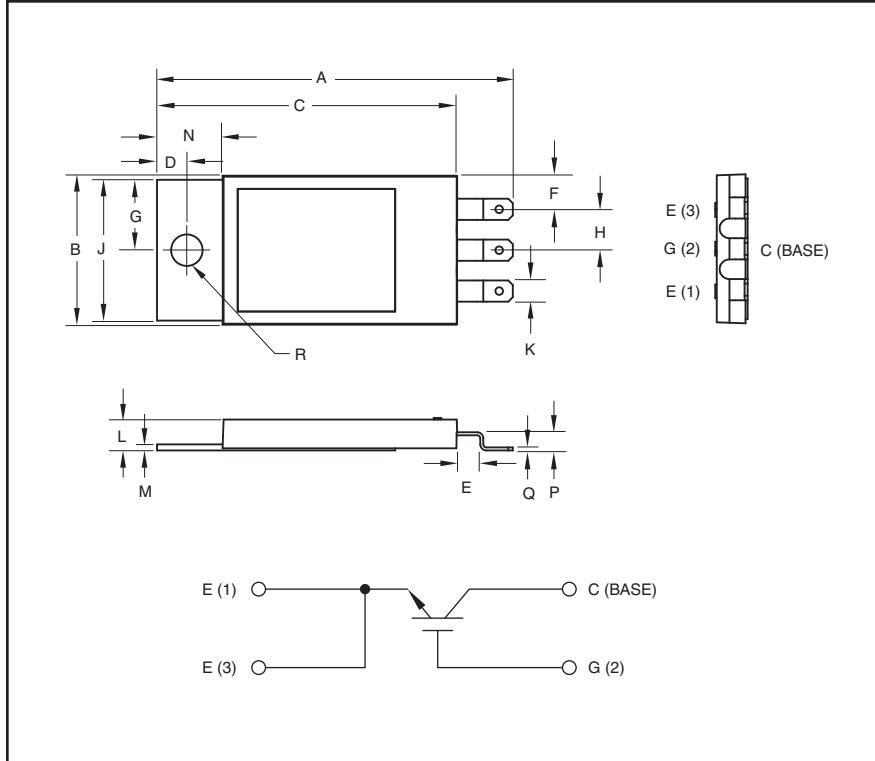

Description:

Powerex Single Non-isolated Discrete is designed specially for customer high voltage switching and pulse power applications.

Features:

- Low Drive Requirement
- Low $V_{CE(sat)}$
- Non-Isolated Molybdenum Mounting Plate
- IGBT is designed to be used by being immersed in oil or conformal coated in assembly

Outline Drawing and Circuit Diagram

Dimensions	Inches	Millimeters
A	2.35	59.7
B	0.98	25.0
C	1.98	50.3
D	0.197	5.0
E	0.22	5.5
F	0.22	5.6
G	0.465	11.8
H	0.27	6.9

Dimensions	Inches	Millimeters
J	0.93	23.6
K	0.14	3.6
L	0.20	5.2
M	0.40	1.0
N	0.43	11.0
P	0.20	0.5
Q	0.12	3.0
R	0.208 Dia.	5.3 Dia.

QIS4506002
HV Single Discrete IGBT
 60 Amperes/4500 Volts

Maximum Ratings, $T_j = 25\text{ }^\circ\text{C}$ unless otherwise specified

Ratings	Symbol	QIS4506002	Units
Collector Emitter Voltage	V_{CES}	4500	Volts
Gate Emitter Voltage	V_{GES}	± 20	Volts
Collector Current (DC, $T_C = 127^\circ\text{C}$)	I_C	60	Amperes
Peak Collector Current (Pulsed)	I_{CM}	120*	Amperes
Junction Temperature	T_j	-55 to 150	$^\circ\text{C}$
Storage Temperature	T_{stg}	-55 to 125	$^\circ\text{C}$
Mounting Torque, M5 Mounting Screws	—	30	in-lb
Weight (Typical)	—	20	Grams

Static Electrical Characteristics, $T_j = 25\text{ }^\circ\text{C}$ unless otherwise specified

Characteristics	Symbol	Test Conditions	Min.	Typ.	Max.	Units
Collector Cutoff Current	I_{CES}	$V_{CE} = V_{CES}, V_{GE} = 0V$	—	—	1.0	mA
Gate Leakage Current	I_{GES}	$V_{GE} = V_{GES}, V_{CE} = 0V$	—	—	0.5	μA
Gate-Emitter Threshold Voltage	$V_{GE(th)}$	$I_C = 7\text{mA}, V_{CE} = 10V$	4.5	6.0	7.5	Volts
Collector-Emitter Saturation Voltage	$V_{CE(sat)}$	$I_C = 60\text{A}, V_{GE} = 15V, T_j = 25^\circ\text{C}$	—	3.0	3.9**	Volts
		$I_C = 60\text{A}, V_{GE} = 15V, T_j = 125^\circ\text{C}$	—	3.6	—	Volts
Total Gate Charge	Q_G	$V_{CC} = 2250V, I_C = 60\text{A}, V_{GE} = 15V$	—	450	—	nC

Dynamic Electrical Characteristics, $T_j = 25\text{ }^\circ\text{C}$ unless otherwise specified

Characteristics	Symbol	Test Conditions	Min.	Typ.	Max.	Units
Input Capacitance	C_{ies}	$V_{GE} = 0V, V_{CE} = 10V$	—	9.0	—	nF
Output Capacitance	C_{oes}		—	0.65	—	nF
Reverse Transfer Capacitance	C_{res}		—	0.2	—	nF
Resistive	Turn-on Delay Time	$V_{CC} = 2250V,$ $I_C = 60\text{A},$	—	—	2.4	μs
	Rise Time		t_r	—	—	2.4
Switching	Turn-off Delay Time	$V_{GE1} = V_{GE2} = 15V,$ $R_G = 120\Omega$	—	—	6.0	μs
	Fall Time		t_f	—	—	1.2
Turn-on Switching Energy	E_{on}	$T_j = 125^\circ\text{C}, I_C = 60\text{A}, V_{CC} = 2250V,$	—	250	—	mJ/P
Turn-off switching Energy	E_{off}	$V_{GE} = \pm 15V, R_G = 120\Omega, L_S = 180\text{nH}$	—	170	—	mJ/P

Thermal and Mechanical Characteristics, $T_j = 25\text{ }^\circ\text{C}$ unless otherwise specified

Characteristics	Symbol	Test Conditions	Min.	Typ.	Max.	Units
Thermal Resistance, Junction to Case	$R_{th(j-c)}$	IGBT	—	0.10	0.12	$^\circ\text{C/W}$
Thermal Resistance, Case to Sink	$R_{th(c-s)}$	$\lambda_{grease} = 1\text{W/mK}$	—	0.10	—	$^\circ\text{C/W}$
Thermal Grease Applied						

* Pulse width and repetition rate should be such that device junction temperature (T_j) does not exceed device rating.
 ** Pulse width and repetition rate should be such that device junction temperature rise is negligible.

QIS4506002
HV Single Discrete IGBT
 60 Amperes/4500 Volts

OUTPUT CHARACTERISTICS (TYPICAL)

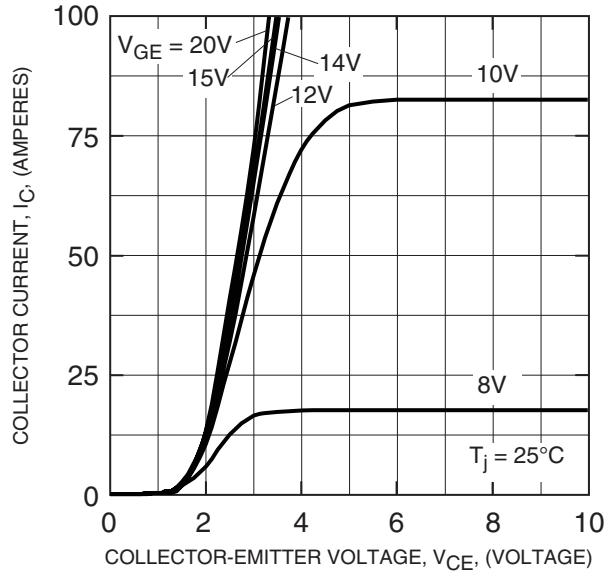

TRANSFER CHARACTERISTICS (TYPICAL)

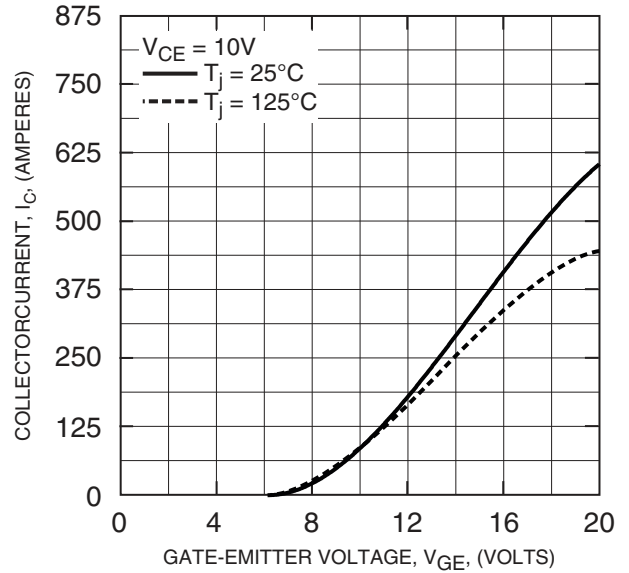

COLLECTOR-EMITTER SATURATION VOLTAGE CHARACTERISTICS (TYPICAL)

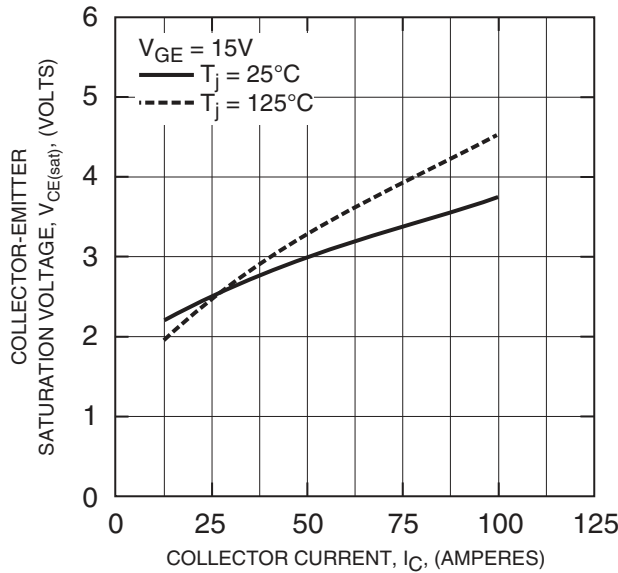

COLLECTOR-EMITTER SATURATION VOLTAGE CHARACTERISTICS (TYPICAL)

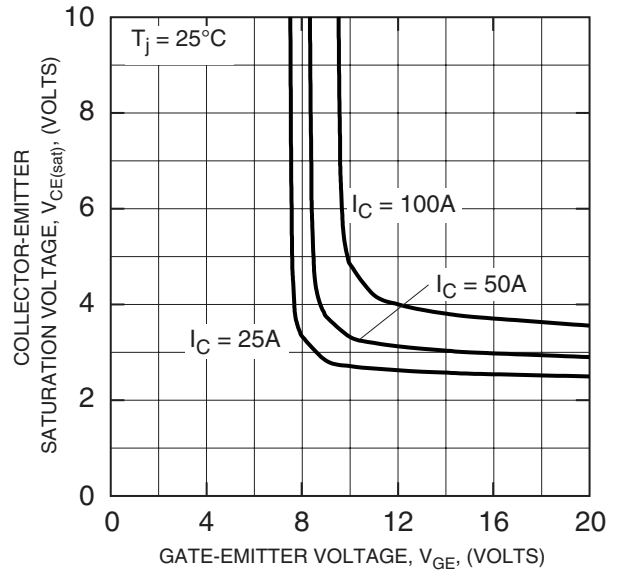

Information presented is based upon manufacturers testing and projected capabilities. This information is subject to change without notice. The manufacturer makes no claim as to the suitability of use, reliability, capability, or future availability of this product.

QIS4506002
HV Single Discrete IGBT
 60 Amperes/4500 Volts

TURN-ON SWITCHING ENERGY CHARACTERISTICS (TYPICAL)

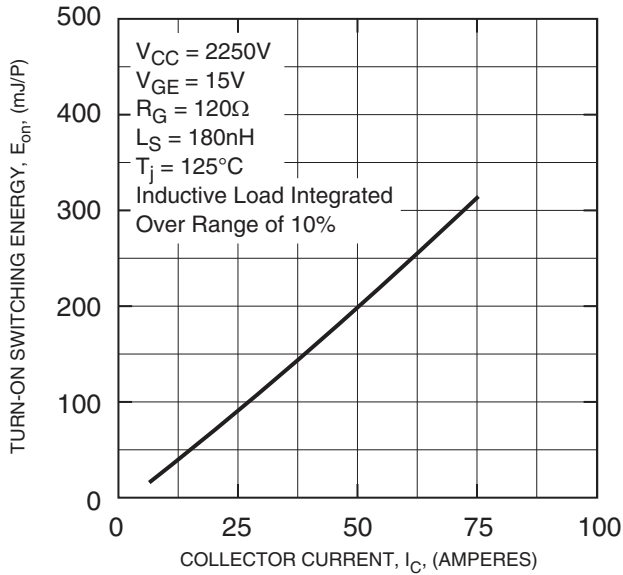

TURN-OFF SWITCHING ENERGY CHARACTERISTICS (TYPICAL)

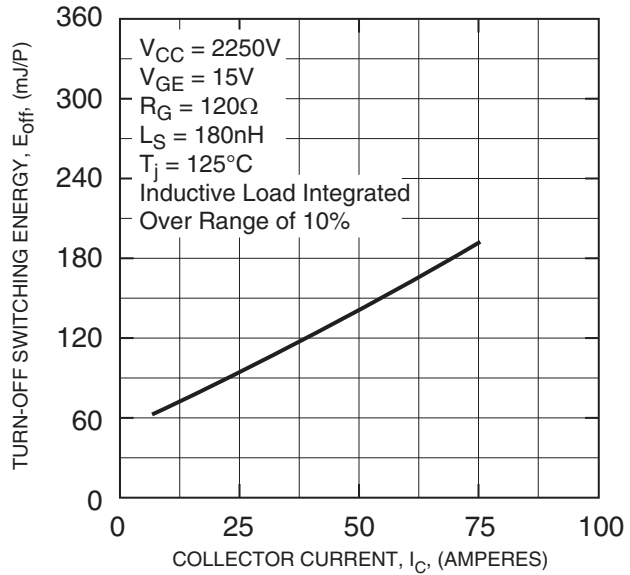

GATE CHARGE CHARACTERISTICS (TYPICAL)

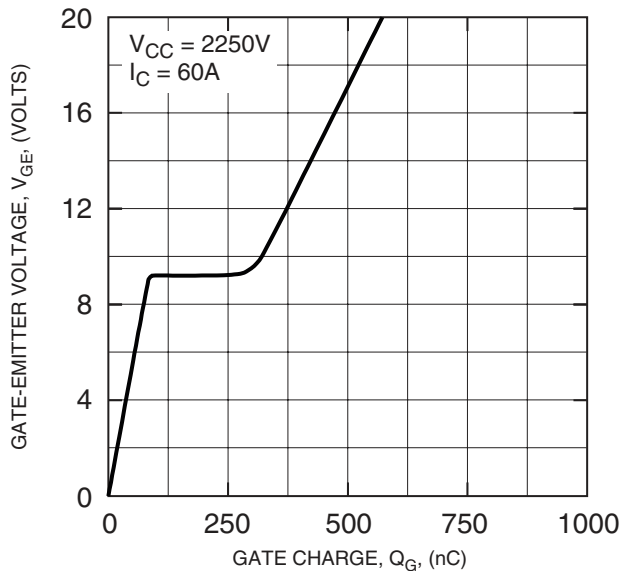

CAPACITANCE CHARACTERISTICS (TYPICAL)

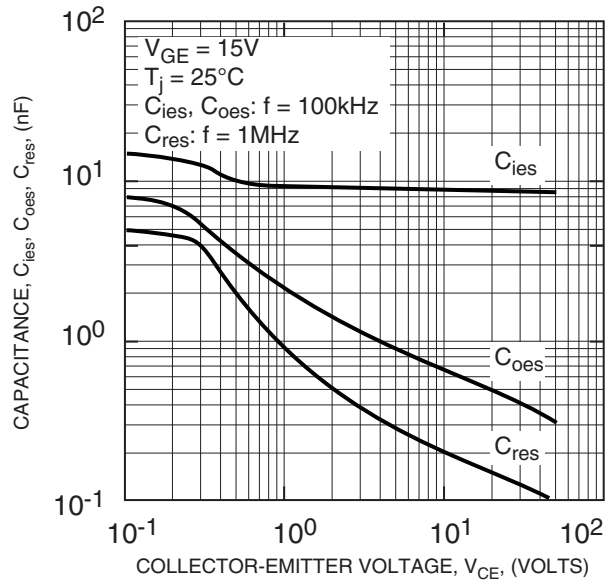

Information presented is based upon manufacturers testing and projected capabilities. This information is subject to change without notice. The manufacturer makes no claim as to the suitability of use, reliability, capability, or future availability of this product.

QIS4506002
HV Single Discrete IGBT
 60 Amperes/4500 Volts

**REVERSE BIAS
 SAFE OPERATING AREA (RBSOA)
 (TYPICAL)**

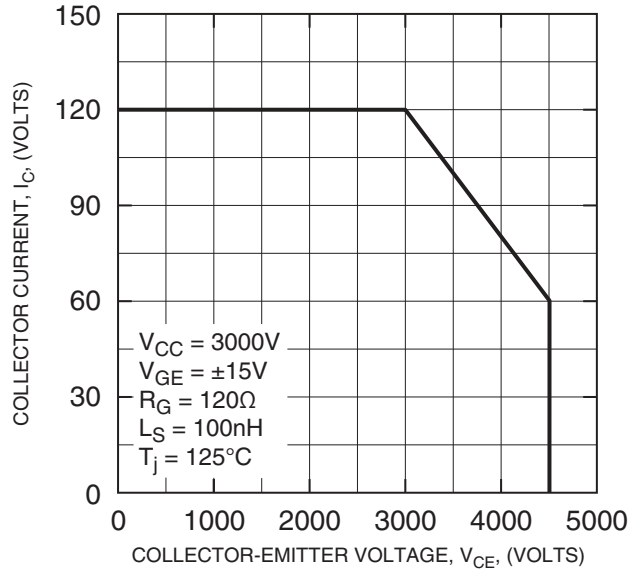

**TRANSIENT THERMAL
 IMPEDANCE CHARACTERISTICS
 (TYPICAL)**

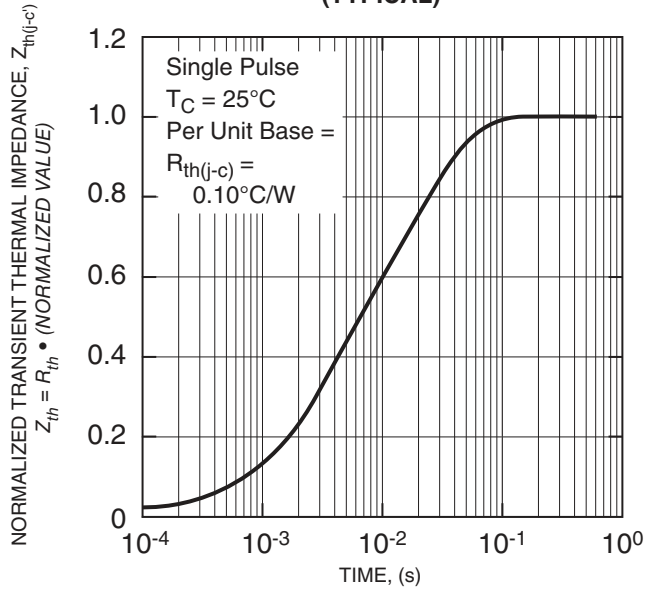

$$Z_{th(j-c)}(t) = \sum_{i=1}^n R_i \left\{ 1 - \exp\left(\frac{-t}{\tau_i}\right) \right\}$$

	1	2	3	4
R_i ($^\circ C/W$)	6.55E-03	1.66E-02	6.24E-03	8.32E-02
τ_i (sec)	3.33E-04	7.57E-04	2.34E-03	1.34E-02