

# 8D Series Power Contacts



## Power Supply in Harsh Environments

Contacts designed to be used in severe environments. Resistant to fluids, high shock and vibration.

**A wide range** ■ All shell materials and platings: from composite to stainless steel.  
Hermetic version available.

**Contact performance** ■ High current: 20% more intensity compared to standard contacts.  
#4 contact: 80A typical, #8 contact: 45A typical.  
High vibration and temperature level.

**Large choice of layouts** ■ 7 layouts with only #4 or only #8 contacts.  
12 mixed layouts available with power contacts.

**User friendly** ■ Easy maintenance with removable contacts.  
Bus bar termination available.



## Description

- Quick screw coupling connector with removable crimp contact
- Shell available in aluminum, composite, Stainless steel, Titanium & Bronze
- Six layouts with different current rating
- Consult us for power hermetic version
- High Power offer available on demand
- Derating curves available for #4 and #8.



## Technical features

### Mechanical

- **Shell:** Aluminum alloy, Composite, Bronze, Stainless steel, Titanium
- **Plating:**
  - . Olive green cadmium (W/J)
  - . Nickel (F/M/TF/S)
  - . Without plating (X for composite, TT for titanium and JVS for Bronze)
  - . Passivated (K)
- **Grommet and seal:** Silicon elastomer
- **Insulator:** Thermoset
- **Contact body:** Copper Alloy
- **Contact retention:**
  - . #4 = 200N
  - . #8 = 111N
- **Shock:** 300g during 3ms
- **Endurance:** 500 mating / unmating operations
- **Vibration:** As per MIL DTL 38999

### Electrical

- **Dielectric withstanding:** Test voltage rating (Vrms)

Service	Sea level	at 21 000 m
M	1 300	800
I	1 800	1 000

- **Insulation Resistance:** 5000 MΩ under 500 Vdc
- **Max current rating per contact:**
  - . #4 = 80A
  - . #8 = 45A
- **Contact resistance:**
  - . #4 = 2mΩ
  - . #8 = 3mΩ
- **Shielding:** As per MIL DTL 38999
- **Shell continuity:**
  - . W = 2.5 mΩ
  - . F = 1mΩ
  - . J, M = 3 mΩ
  - . JVS = 5 mΩ

### Environmental

- **Temperature range:**
  - . W, J, X, JVS = - 65°C +175°C
  - . F, M, K, S, TT, TF = - 65°C +200°C
- **Sealing:** As per MIL DTL 38999
- **Damp Heat:** As per MIL DTL 38999
- **Salt Spray:**
  - . W, TT, TF, K, JVS = 500 hours
  - . F, S = 48 hours
  - . J,M,X = 2000 hours
- **Fire resistance:** As per EN 2591 - C 17 method A
- **Resistance to fluid:** As per MIL DTL 38999

## Connector part numbers

### Aluminum, Composite, Stainless steel & Titanium connector

<b>Basic Series</b>	8D	0	-	11	W	80	P	N	251
<b>Style:</b>									
0: Square flange receptacle									
5: Plug with RFI shielding									
7: Jam nut receptacle									
<b>Type:</b> Crimp contact									
<b>Shell size:</b> 11 - 17 - 19 - 21 - 23 - 25									
<b>Plating:</b>									
<b>Aluminum shell:</b>									
W: Olive drab cadmium									
F: Nickel									
ZC: Green zinc cobalt									
Z: Black zinc nickel									
<b>Composite shell:</b>									
J: Olive green cadmium									
M: Nickel									
X: Without plating									
<b>Stainless steel shell:</b>									
K: Corrosion resistant									
S: Nickel									
<b>Titanium shell:</b>									
TT: Without plating									
TF: Nickel									
<b>Contact layouts:</b> See next page									
<b>Contact style:</b>									
P: Pin contact                      A: Male connector supplied without contact									
S: Socket contact                B: Female connector supplied without contact									
<b>Orientation:</b> N - A - B - C - D - E									
<b>Specification:</b>									
251: Mandatory for some layouts supplied with power contacts (see next page)									

### Bronze connector





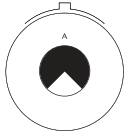
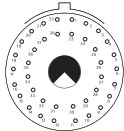
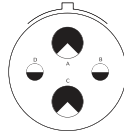
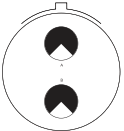
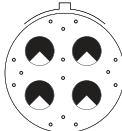

<b>Basic Series</b>	JVS	16	A	11	80	P	N	251
<b>Style:</b>								
00: Square flange receptacle								
07: Jam nut receptacle								
16: Plug								
<b>Material:</b>								
A: Bronze shell material								
<b>Shell size:</b> 11 - 17 - 19 - 21 - 23 - 25								
<b>Contact layouts:</b> See next page								
<b>Contact style:</b>								
P: Pin contact                      A: Male connector supplied without contact								
S: Socket contact                B: Female connector supplied without contact								
<b>Orientation:</b> N - A - B - C - D - E								
<b>Specification:</b>								
251: Mandatory for some layouts supplied with power contacts (see next page)								

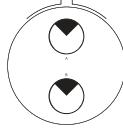
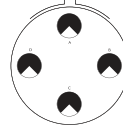
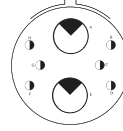
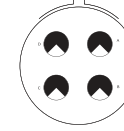
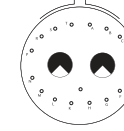
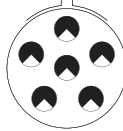
### Contact layouts

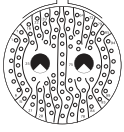
-  Contact #22D
-  Contact #12
-  Contact #20
-  Contact #8 Power
-  Contact #16
-  Contact #4 Power

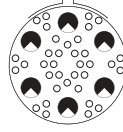
<b>11</b>				<b>17</b>				<b>19</b>
80 Spec 251				02 Spec 251	22 Spec 251	75 Spec 251		
								
1#8				38#22D 1#8	2#12 2#8	2#8		
						18 Spec 251		
								
						14#22D 4#8		

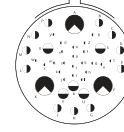
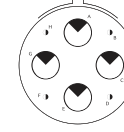
<b>21</b>							<b>23</b>
20 Spec 251	42*	48*	72*	75 Spec 251	77 Spec 251	06 Spec 251	
							
18#20 2#8	2#4	4#8	6#16 2#4	4#8	17#22D 2#8	6#8	

<b>25</b>						
07 Spec 251	08 Spec 251	17 Spec 251	20 Spec 251	41 Spec 251	44*	46 Spec 251
						
97#22D 2#8	8#8	36 #22D 6 #8	10#20 13#16 4#12 3#8	22#22D, 3#20 11#16, 2#12 3#8	4#16 4#4	40#20 4#16 2#8

\* Power contacts on standard, no spec. 251 needed.

### Power contacts

Contact size	Contact type	Part number	Reducer	Cable size max.		Boot
				AWG	mm <sup>2</sup>	
#4	Male	85997598900*	Without	N/A	25 mm <sup>2</sup>	N/A not sealed
	Female	85997599900*				
	Male	85997534		AWG 4	16 to 21 mm <sup>2</sup>	85994594 for cable 16mm <sup>2</sup>
	Female	85997535				
	Male	85997524		AWG8	9 mm <sup>2</sup>	N/A not sealed
	Female	85997525				
	Male	85997534	84002352A	AWG6	10 mm <sup>2</sup>	85994593
	Female	85997535				
	Male	85997528900	Without	AWG6	10 mm <sup>2</sup>	
	Female	85997529900				
#8	Male	85997580	Without	AWG8	9 mm <sup>2</sup>	85994542
	Female	85997581				
	Male	85997580	85997645	AWG10	6 mm <sup>2</sup>	85994547
	Female	85997581				
#8 according to EN 3155	Male	85996215900	Without	AWG8	9 mm <sup>2</sup>	85994542
	Female	85996217900				
	Male	85996216900		AWG10	6 mm <sup>2</sup>	85994547
	Female	85996218900				
#8 JVS only	Male	85997544	Without	AWG8	9 mm <sup>2</sup>	85994542
	Female	85997541				
	Male	85997544	85997645	AWG10	6 mm <sup>2</sup>	85994547
	Female	85997541				

Cable section AWG	#22	#20	#16	#12	#10	#8	#4
mm <sup>2</sup> maxi	0.34	0.6	1.34	3.18	5.8	9	21
mm <sup>2</sup> mini	0.095	0.21	0.6	1.91	3.8	5.8	16

\* Not included in connector P/N. Must be ordered separately.

### Bus bar contact

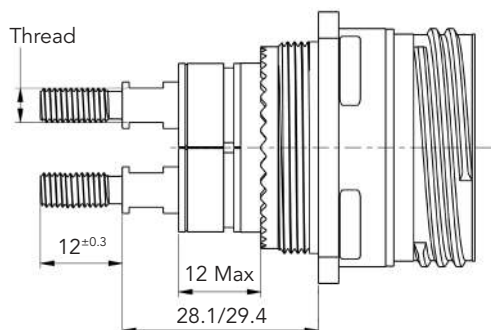

Contact size	Thread	Part number			Lug Ø
		Male	Female	Boots	
#4	M5x0.8	85930873A900	85930875A900	85994594	5.2
#8	M3x0.5	85930872A900	85930874A900	85994542	3.2

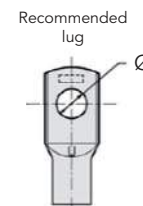

Contacts available separately only. Lug: tin over copper recommended. Dimensions for indication only.

Note: All dimensions are in millimeters (mm)

**Power tools**

Contact size	Contact type	Contact reference	Cable AWG	Crimping tool			Contact extraction tool (metallic)	Contact extraction tool (plastic)
				Automatic tool: M22520/23-01		Manual hand tool: M300 BT		
				Die set	Locator	Locator		
#4	Male	8599-7534	#4-5 or #10-16mm <sup>2</sup>	M22520/23-04	M22520/23-11	N/A	8533-8175	M81969/14-07
	Female	8599-7535						
#8 JVS only	Male	8599-7544	#8 or #10	M22520/23-02	8599-9601	SP 593	8660-197	M81969/14-12
	Female	8599-7541						
#8	Male	8599-7580						
	Female	8599-7581						

**Automatic tool for contacts #4 & #8**



Crimping tool M22520/23-01



Die set



Locator

**Manual hand tool for contacts #8**



Crimping tool M300 BT



Locator

**Extraction tool**



Metallic tool

For further information contact us at [technical.emear@souriau.com](mailto:technical.emear@souriau.com) (Europe - Asia - Africa)  
[technical.americas@souriau.com](mailto:technical.americas@souriau.com) (North America)  
 or visit our web site [www.souriau.com](http://www.souriau.com)