

# CLP0412 Open Frame Power Supply

90 - 265Vac Input; 12Vdc Output; 450W Output Power;  
Trapezoidal 75-130Vac Input; 12Vdc Output

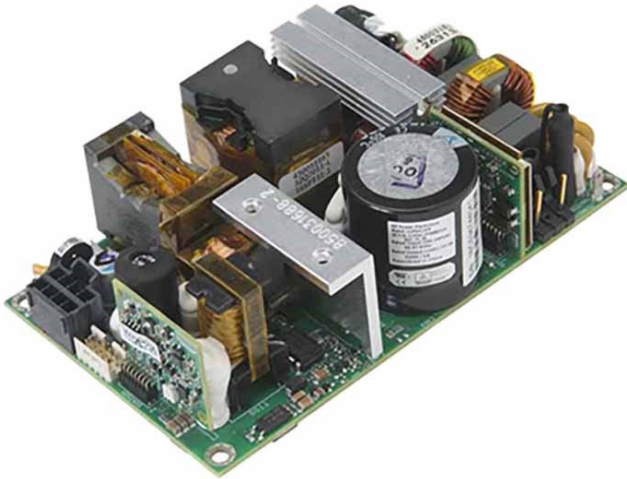

In a small 3 x 5-inch footprint, the 12Vdc single-output CLP0412 open frame power supply delivers 92 percent typical power efficiency at 42° C and 1m/s airflow. With its small size, the CLP series is specifically designed to handle power challenges associated with tight space and low airflow.

## Description

Offering a high 20.7W/in<sup>3</sup> power density in a 1U high, fan-less form factor, the CLP series addresses a broad range of applications in new products from industrial equipment and communications original equipment manufacturers (OEMs). Higher temperature operation is possible at derated output. The CLP series utilizes a unique design approach at this power level, leveraging zero voltage switching techniques in conjunction with quasi-resonant power factor correction (PFC) circuits. Protection features include overcurrent (OCP), overvoltage (OVP), and overtemperature (OTP). Applications include: Industrial Equipment | Telecommunications Equipment | CATV Equipment (Trapezoidal Input)

## Features

- Compact size 76.2 mm x 127 mm x 36.8 mm (3 in x 5 in x 1.45 in) with density of 20.7 W/in<sup>3</sup>
- Universal AC Input Range (90 - 265VAC)
- Trapezoid AC Input Range (75V - 130VAC)
- Output voltage of 12V or 54V (adjustable ±3%)
- Standby output of 5V @ 1A (standard versions)
- Maximum output current of 37.5A @ 12Vout (450W)
- High efficiency (92% at Full Load, 230VAC in)
- 450W capability at 42° C and 1m/s airflow with derating at higher temperatures or lower airflows
- Capable of 320W output in sealed enclosure applications, with enclosure ambient at 55° C
- Capable of 225W at 75Vin Trapezoidal inside sealed enclosure with enclosure outside ambient at 55° C
- Output overcurrent protection (non-latching)
- Overtemperature and output over-voltage protections
- Minimum of 11ms of holdup time at 450W out
- Parallelable with output current sharing
- Active power factor corrected input
- Conducted EMI - meets CISPR22 (EN55022) and FCC Class B requirements
- Meets IEC61000-4-5, Level 4 (2kV/4kV)
- UL and cUL approved to UL/CSA60950-1, TUV (EN60950-1), CE Mark (for LVD) and CB Report available
- ISO\*\* 9001 and ISO 14001 certified manufacturing facilities

See footnotes on page 4

# Technical Specifications

## Absolute Maximum Ratings

Stresses over the absolute maximum ratings can cause permanent damage to the device. These are absolute stress ratings only. Functional operation of the device is not implied at these or any other conditions over those given in the operations sections of the data sheet. Exposure to absolute maximum ratings for extended periods can adversely affect the device reliability.

Parameter	Device	Min	Max	Unit
Input Voltage - Continuous Operation	All	90	265	Vac
For up to 10 seconds operation	All	90	275	Vac
Input Voltage-continuous-CATV Powering trapezoidal wave-form (Note: Output power is limited to 254W when 75V input, 275W when 90V input, 320W when 130V input)	CLP0412-FPXXX-Z05A	75	130	V <sub>RMS</sub>
Operating Ambient Temperature (see Thermal Considerations section)	All	-40	85	°C
Storage Temperature	All	-40	85	°C
Humidity (non-condensing)	All	5	95	%
Altitude	All		5000	m
Isolation Voltage—Input to output	All		3000	Vac
Input to safety ground	All		1500	Vac
Outputs to safety ground	All		50	Vac

## Electrical Specifications

Parameter	Device	Min	Typ	Max	Unit
Operating Input Voltage	All	90	115/230	265	Vac
	CLP0412FPXXXZ05A	75	90	130	V <sub>RMS</sub>
Input Source Frequency	All	47	50/60	63	Hz
Input Current (V <sub>IN</sub> = 90Vac)	All		5.57		A <sub>RMS</sub>
Input Power Factor (230Vac, Full Load)	All	0.95			
Inrush Transient Current (V <sub>IN</sub> = 265Vac, T <sub>amb</sub> = 25°C)	All			60	A Peak
Leakage Current to earth ground (V <sub>IN</sub> = 265Vac)	All			3.5	mA
Output Voltage Setpoint	All		12		Vdc
Output Voltage Tolerance (due to set point, temperature variations, load and line regulation)	All	-2		2	%
Output Voltage Adjustment Range (adjust potentiometer see page 9)	Z01A	45		51	Vdc
Output Remote Sense Range	All			250	mVdc
Output Load Regulation	All			1	%Vout
Output Line Regulation	All			0.5	%Vout
Output Ripple and Noise – measured with 0.1µF ceramic capacitor and 470µF polymer capacitor in parallel. <sup>1</sup> Peak-to-peak (20MHz Bandwidth)	All			240	mV p-p
Dynamic Load Response – 50% to 100% load transient, 1°/µs slew rate					
Output voltage deviation	All			5%	%
Settling Time	All			500	µs
Output Current	Z01A	0		37.5	Adc
	Z03A	0		37.5	Adc
	Z05A	0		26.7	Adc
Output Current Limit Inception	All	105		140	% I <sub>O,max</sub>
Maximum Output Capacitance	All			1000	µF
Standby Output Voltage	All		5		Vdc
Standby Output Current	All			1	Adc

-continued on next page-

See footnotes on page 4

# Technical Specifications (continued)

## Electrical Specifications con't.

Parameter	Device	Min	Typ	Max	Unit
Efficiency: $V_{IN} = 230V_{ac}$ —	20% load	All	86.8		%
	50% load	All	91.7		%
	100% load	All	91.9		%
Efficiency: $V_{IN} = 115V_{ac}$ —	20% load	All	85.8		%
	50% load	All	89.9		%
	100% load	All	89.7		%
Efficiency: $V_{IN} = 115V_{ac}$ —	20% load		76.8		%
	50% load	Z05A	88.1		%
	100% load		90.2		%
Holdup Time <sup>2</sup> — $V_{IN} = 115$ or $230V_{ac}$ , 450W load	All	11			ms

## General Specifications

Parameter	Device	Symbol	Typ	Unit
Calculated Reliability based on Telcordia SR-332 Issue 3: Method 1 Case 3 ( $V_{IN}=230V_{ac}$ , $I_o = 30A$ , $T_A = 40^{\circ}C$ , airflow 200LFM, 90% confidence)	All	MTBF	2,938,636	Hours
Weight	All		382 13.5	g oz.

## Feature Specifications

Parameter	Device	Min	Typ	Max	Unit
<b>On/Off Signal Interface – signal referenced to zero</b>					
<b>Logic Low (Power Supply ON)</b>					
Input Low Current	All			7	mA
Input Low Voltage	All			1	V
<b>Logic High (Power Supply OFF)</b>					
Input High Current	All			600	$\mu A$
Input Voltage	All			5.5	V
Delay from ON/OFF being enabled to start of output voltage rise	All			50	ms
Output Voltage Rise Time (from 10 to 90% of final value)	All		20		ms
Delay from Input being applied to all outputs being in regulation	All			1	S
Output Overvoltage Protection	All	13.8		16	Vdc
<b>Input Undervoltage lockout<sup>3</sup></b>					
Turn-on Threshold (100% load)	Z01A	85.0	87.6	90	Vac
	Z03A	85.0	87.6	90	Vac
	Z05A		72		$V_{RMS}$
Turn-off Threshold (100% load)	Z01A	82.0	83.9	88	Vac
	Z03A	82.0	83.9	88	Vac
	Z05A		69		$V_{RMS}$
<b>DC OK – open collector, High when output available</b>					
Sink Current	All			4	mA
Maximum Collector Voltage	All			12	V

See footnotes on page 4

## Technical Specifications (continued)

### Safety Specifications

Parameter	Device	Specification
Dielectric Withstand Voltage (between input and output)	All	Minimum of 4,250Vdc for 1 minute
Insulation Resistance (between input and output)	All	Minimum of 5 MΩ
Safety Standards	All	Class 1, IEC60950, EN60950, with the following deviations: Nemko, UL 60950 (Recognized Component), cUL (Canadian Approval by UL)

### Environmental Specifications

Parameter	Device	Specification
Radiated Emissions <sup>4</sup>	All	CISPR22 Class B with 3dB margin
Conducted Emissions	All	CISPR22 Class B with 6dB margin
ESD	All	IEC 61000-4-2, Level 4 Performance Criteria
Radiated Susceptibility <sup>5</sup>	All	IEC 61000-4-3, Level 3
Electrical Fast Transient Common Mode	All	IEC 61000-4-4, Level 3
Surge Immunity	All	IEC 61000-4-5, Level 4
Conducted RF Immunity	All	IEC 61000-4-6, Level 3
Input Voltage Dips	All	Output stays within regulation for either ½ cycle interruption or 25% dip from nominal line for 1 second
Input Harmonics	All	IEC61000-3-2
Shock and Vibration	All	Per IPC-9592B, Class II

#### FOOTNOTES

\*UL is a registered trademark of Underwriters Laboratories, Inc.

†CSA is a registered trademark of Canadian Standards Association.

‡VDE is a registered trademark of Verband Deutscher Elektrotechniker e.V.

\*\*ISO is a registered trademark of the International Organization of Standard

<sup>1</sup> Output ripple specification is met over 25 to 85°C

<sup>2</sup> Holdup time may be lower at cold temperatures

<sup>3</sup> Undervoltage lockout threshold may vary with output load current level – decreasing as load goes lower

<sup>4</sup> Meets when tested in a suitable enclosure

<sup>5</sup> Meets when tested in a suitable enclosure

# Technical Specifications (continued)

## Characteristic Curves (CLP0412)

The following figures provide typical characteristics for the CLP0412 power supply.

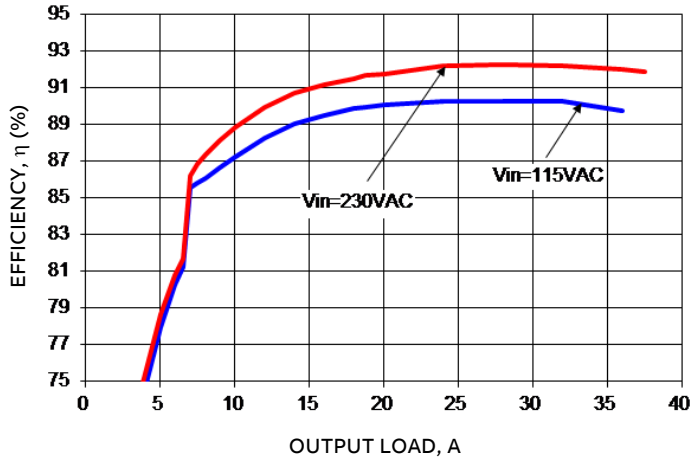

Figure 1: Power Supply Efficiency Versus Out Current

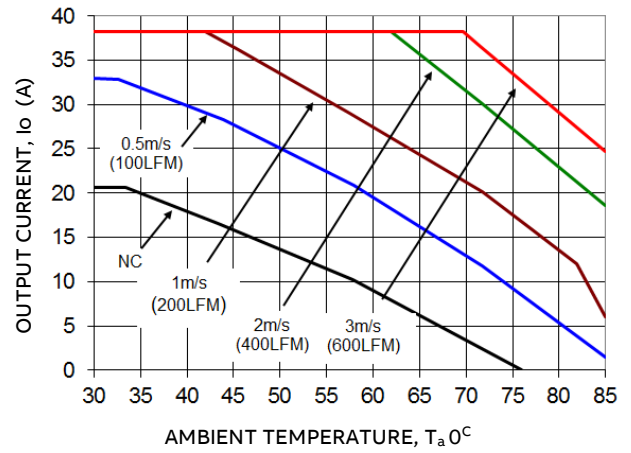

Figure 2: Power. Data shown for model CLP0412FPXXXZ03A, 115VAC in. At 230VAC in derating is the same or better. Standby output is loaded at 0.25A. For derating at other input voltages and other models, consult the GE Technical representative.

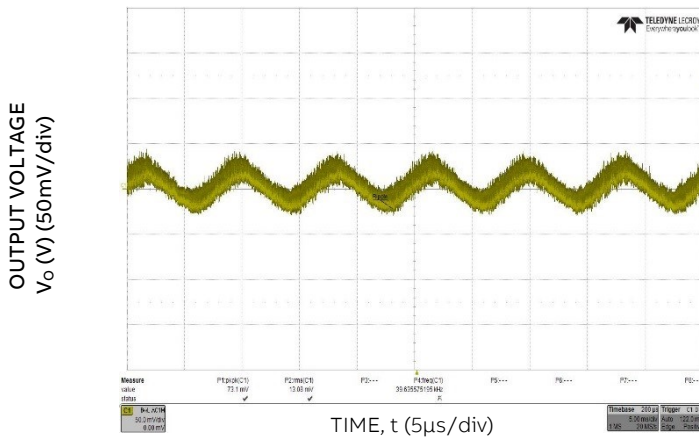

Figure 3. Typical output ripple and noise ( $V_{IN} = 115\text{Vac}$ , 100% load)

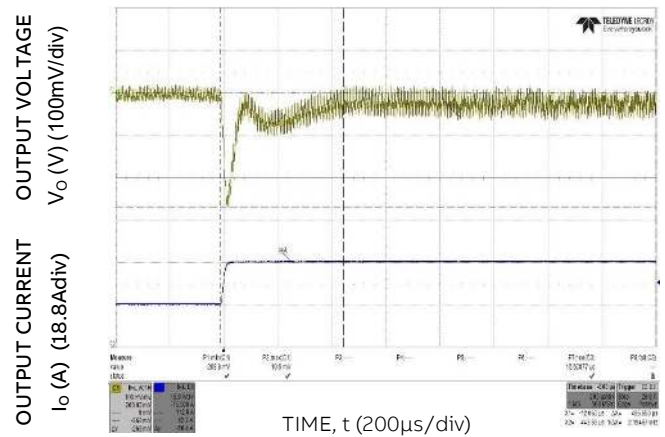

Figure 4. Transient Response to Dynamic Load Change from 50% to 100% at  $V_{IN} = 115\text{Vac}$

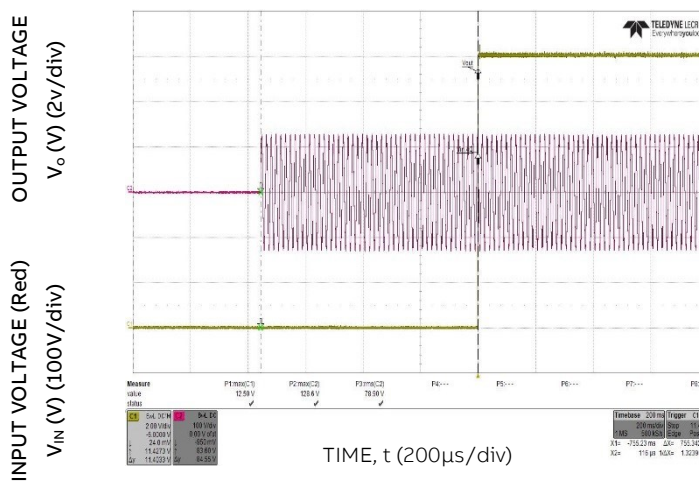

Figure 5. Typical Start-up ( $V_{IN} = 90\text{Vac}$ , Full Load)

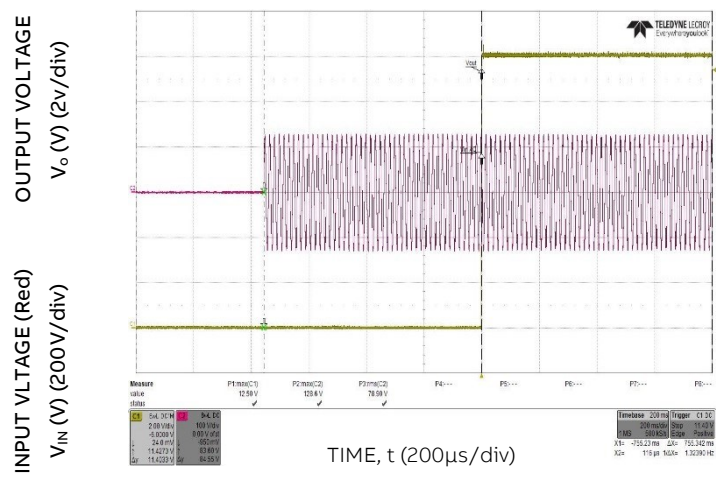

Figure 6. Typical Start-up ( $V_{IN} = 230\text{Vac}$ , Full Load)

# Technical Specifications (continued)

## Characteristic Curves con't. (CLP0412)

The following figures provide typical characteristics for the CLP0412 power supply.

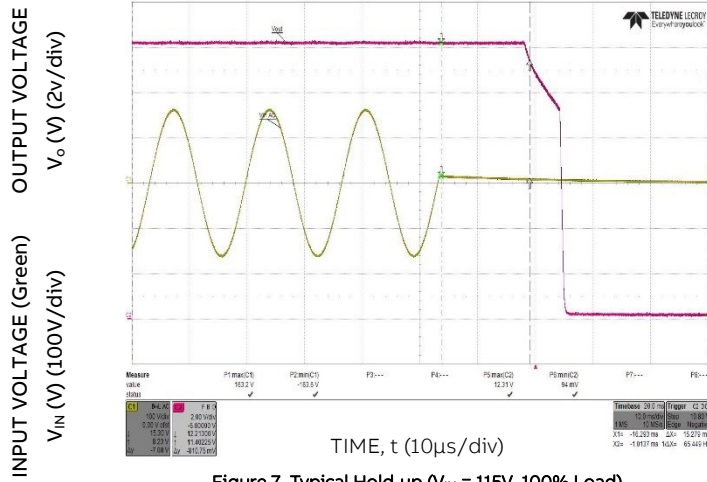

Figure 7. Typical Hold-up ( $V_{IN} = 115V$ , 100% Load)

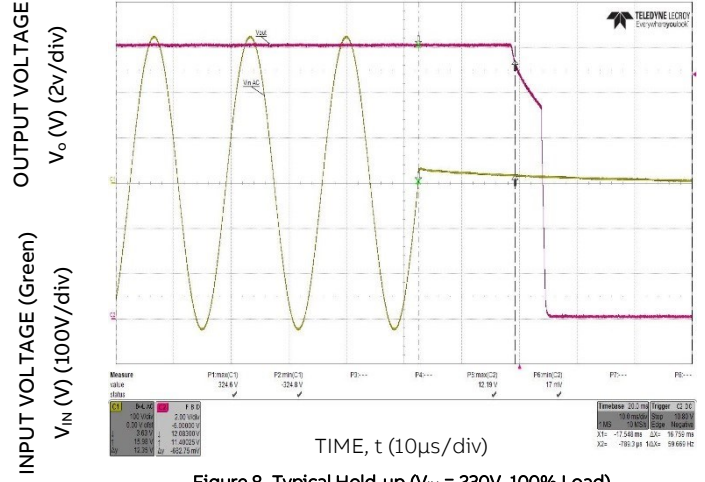

Figure 8. Typical Hold-up ( $V_{IN} = 230V$ , 100% Load)

# Technical Specifications (continued)

## Safety Considerations

The CLP0412 embedded power supply is intended for inclusion in end product equipment and shall be installed in compliance with the enclosure, mounting, spacing, casualty and segregation requirements of the end-use application. A suitable Electrical and Fire enclosure shall be provided and is not intended to be operated as a stand-alone product. It is cURus, TUV approved using the applicable requirements in the Safety of Information Technology Equipment – Safety – Part 1: General Requirements, ANSI/UL60950-1-2014 and CAN/CSA C22.2 No. 60950-1-07, Second Edition + A2:2014 (MOD), dated October 14, 2014 and EN60950-1:2006+A2:2013. A CB report to the requirement of IEC60950-1 2<sup>nd</sup> Ed. + Am1 + Am2 with global national deviations has been issued.

## Feature Descriptions

### Standby Power Supply

A standby output of 5V in the CLP0412 power supply, comes on when AC input in the operating range is applied.

### Remote On/Off

The CLP0412 power supply features a TTL-compatible On/Off control input. The power supply turns ON when the On/Off input goes low, and turns OFF when the input goes high. Note that if the On/Off pin is left unconnected, the power supply main output will turn ON when AC input is present.

### Output Voltage Adjustment

For all units, the output voltage can be adjusted between 11.4V and 12.6V using a potentiometer on the power supply.

### Remote Sense

For all versions, the power supply has both positive and negative remote sense connections that can be connected to the positive and negative rails of the main output near the load. The power supply operates even without the remote sense connections being made.

### Overcurrent Protection

To provide protection in a fault condition (output overload), the power supply is equipped with internal current-limiting circuitry and can endure current limiting continuously. At the point of current-limit inception, the unit enters hiccup mode. The power supply operates normally once the output current is brought back into its specified range.

### Overvoltage Protection

Overvoltage protection is a feature of the CLP0412 power supply that protects both the load and the power supply from an output overvoltage condition. When an overvoltage occurs, the power supply shuts down and latches off until the

overvoltage condition is removed. It is necessary to recycle the input to restart the power supply when this protection is activated.

### Overtemperature Protection

For additional protection in a fault condition the CLP0412 is equipped with a thermal shutdown circuit which detects excessive internal temperatures and shuts the unit down. Once the power supply goes into overtemperature shutdown, it will cool before attempting to restart. The overtemperature protection circuit will typically kick in when the unit is operated at 450W output with an ambient temperature of 53°C and 1m/s (200LFM) airflow. In a sealed enclosure OTP will depend on enclosure design and cooling.

### Input Undervoltage Lockout

At input voltages below the input under-voltage lockout limit, power supply operation is disabled. The power supply will begin to operate at an input voltage above the under-voltage lockout turn-on threshold.

### DC OK

The CLP0412 provides a DC OK signal that indicates when the output has come up and is in regulation. This is an open-collector type signal that goes high when the output is available and within regulation.

### Power Good LED

A green LED on board the power supply illuminates when the main output voltage is above 10V.

### Paralleling with Active Output Current Sharing

The CLP0412 is capable of being employed in a paralleling scheme, following are some design attributes that need to be carefully considered prior to attempting a parallel operation with multiple CLP0412's. With the following design criteria the CLP0412 will load share at an accuracy of +/-5%, when the total current draw is at levels above 20% of max overall loading.

Current share signals of each power supply to be connected.

An external Oring function needs to be employed at the Vout(+) signal. An oring diode or a Mosfet & controller scheme can be used.

The 5V Standby Return SHOULD NEVER be connected with the VOUT-(RETURN). 5V stby returns will need to be connected together, the 5V stby Vout(+) leg remain separate. The 5V stby output is not designed to be paralleled, if there is a desire for these to be paralleled for load sharing, then other considerations need to be included as well. Contact your local GE sales rep for FAE involvement.

In the parallel scheme the remote sense function needs to be unused and remote sense signals left floating.

# Technical Specifications (continued)

## Thermal Considerations

The power supply can be operated in a variety of thermal environments; however sufficient cooling should be provided to ensure reliable operation.

Considerations include ambient temperature, airflow, power supply dissipation and the need for increased reliability.

A reduction in the operating temperature of the power supply will result in increased reliability. The thermal data presented here is based on measurements taken during testing in a wind tunnel or temperature chamber.

## Heat Transfer via Convection

Increased airflow through the power supply enhances the heat transfer via convection. Figure below shows the preferred airflow direction. Contact your ABB technical representative for derating information in other airflow directions.

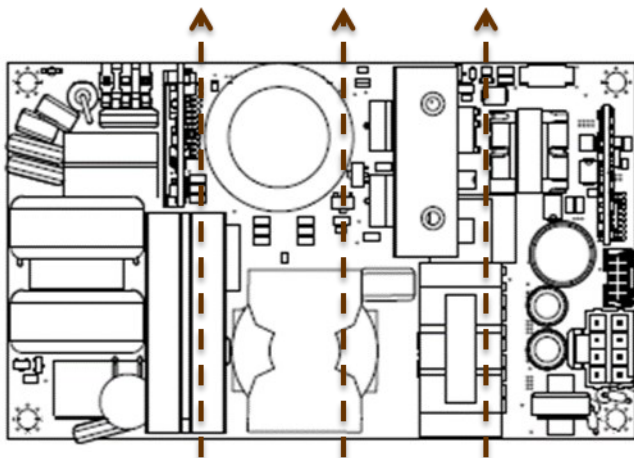

Fig.9. Preferred airflow direction for cooling.

## Operation in a Sealed Enclosure (201A and 205A)

The CLP0412 power supply can also be operated in a sealed enclosure or in an environment where cooling is primarily via conduction. Figure 11 shows an arrangement where thermally conductive pads are used to transfer heat from the top and bottom of the power supply into the enclosure. Under such conditions, the power supply is capable of reduced power operation as shown in Table 1.

Outside Ambient Temperature (°C)	Max. Output Power (W)
25	420
55	320

Table 1. Output Power Capability when the CLP0412FPXXXZ01A is cooled primarily via conduction.

Vin(T)	Max. Output Current (A)	Max. Output Power (W)	Max. Enclosure Outside Ambient (°C)
75	21.2	225	55
90	22.9	275	55
130	26.7	320	55

Table 2. Output Power Capability for Trapezoidal Input when the CLP0412FPXXXZ05A is cooled primarily via conduction.

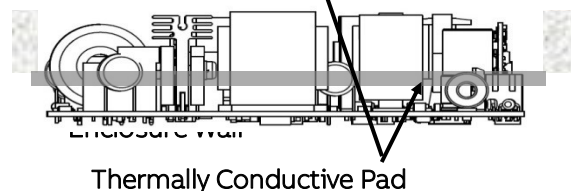
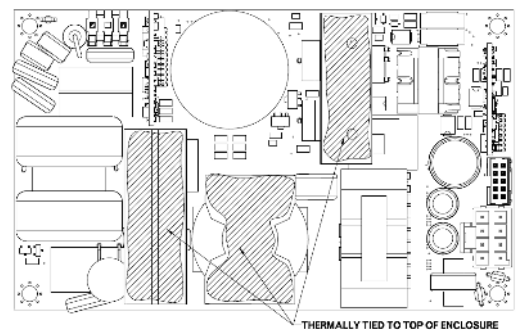
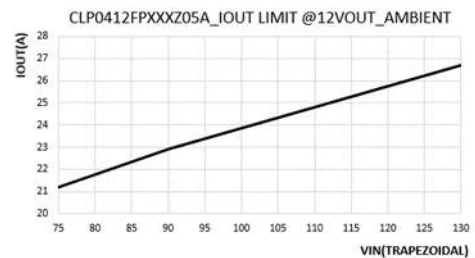

Fig. 11. Example arrangement of the CLP0412 for sealed enclosure applications.

## Difference Between Z01A and Z03A Product Codes

The only difference between Z01A (Enclosure Version) and the Z03A (Airflow Version) is the over temperature protection (OTP) setpoints. For the Z01A enclosure version, the OTP setpoints were lowered to protect the unit from excessive temperatures in the enclosure environment. For the Z03A airflow version the OTP trip points were increased to a higher temperature, while still maintaining safe component temperatures. OTP setpoints were increased on the airflow version in order to obtain better derating performance in airflow applications.



# Technical Specifications (continued)

## Mechanical Outline (CLP0412)

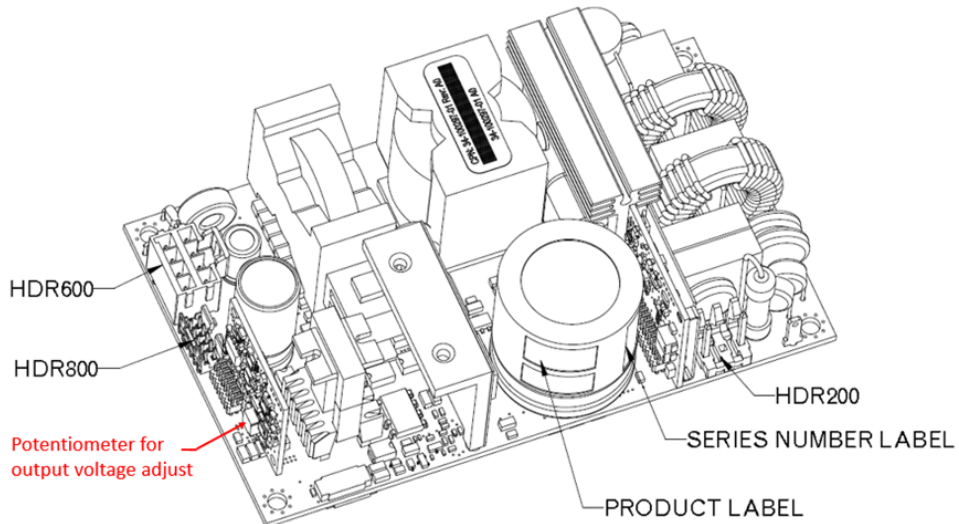
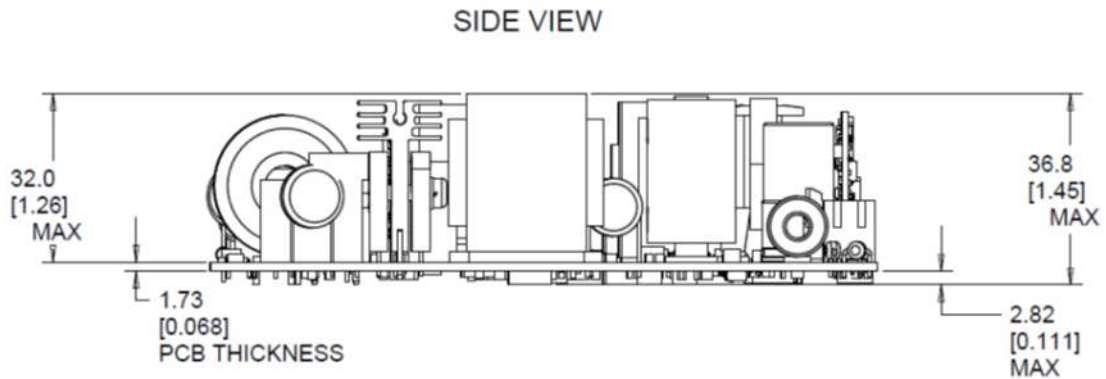
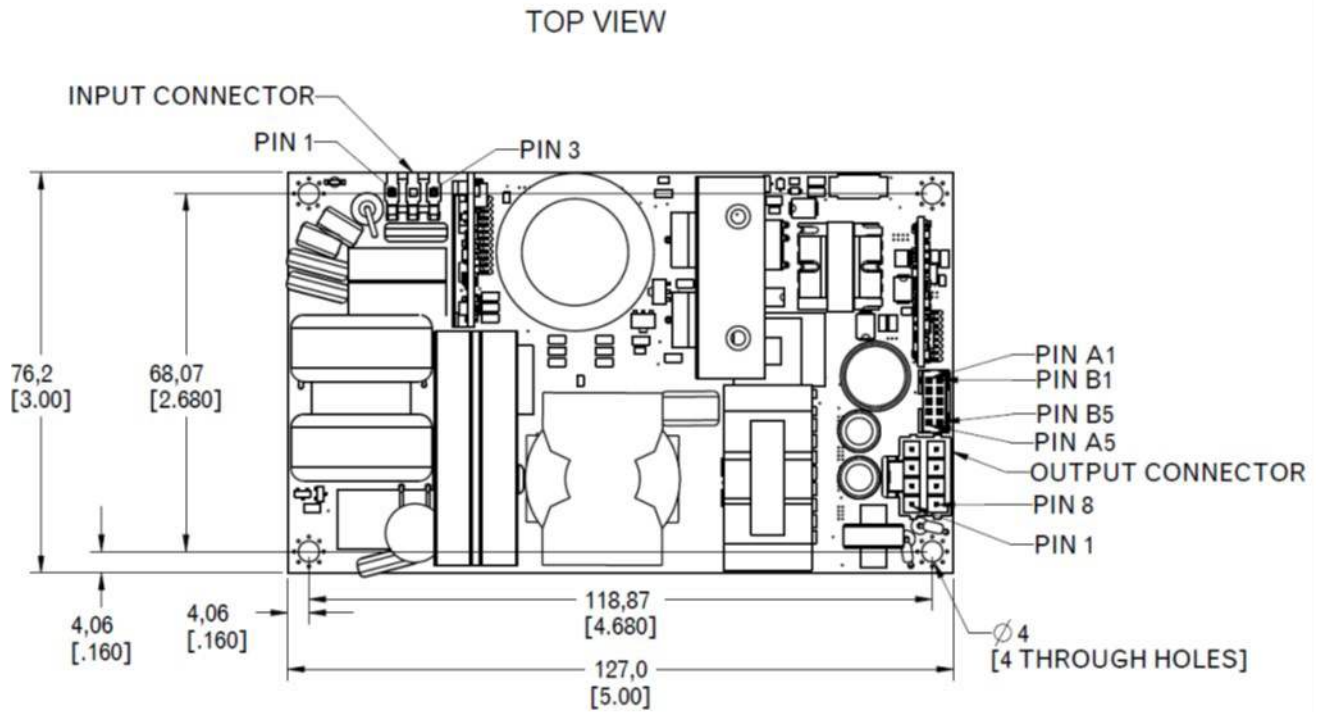

## Technical Specifications (continued)

### Connector Information

Connector	Connector on Power Supply	Mating Connector
AC Input Connector (HDR200)	Molex 41671-3473 or equivalent	Molex 09-50-8031 or equivalent
DC Output Connector (HDR600)	Molex 172298-1208 or equivalent	Molex 172258-1008 or equivalent
Auxiliary Connector (HDR800)	FCI 98414-G04-10ULF or equivalent	FCI 90311-010LF or equivalent

### Pinout Information

AC Input Connector		DC Output Connector		Auxiliary Connector	
Pin 1	Line	Pin 1, 2, 3, 4	VOUT +	Pin A1 - SV Standby	Pin B1 - PARALLEL
Pin 2	NC (removed)	Pin 5, 6, 7, 8	VOUT - (return)	Pin A2 - SV Standby	Pin B2 - SV Standby Return
Pin 3	Neutral			Pin A3 - NC	Pin B3 - SV Standby Return
				Pin A4 - REMOTE SENSE +	Pin B4 - DC_OK
				Pin A5 - REMOTE SENSE -	Pin B5 - ON/OFF

### Ordering Information

Device Code	Input Voltage Range	Output Voltage	Output Current	On/Off Control	Standby Supply	Temperature Range	Intended Application	Comcodes
CLP0412FPXX XZ01A	90-265Vac	12.0Vdc	37.5A	Negative Logic	5V@A	-40 to 85°C	Enclosed with conduction cooling*	CLP0412FPXXXZ01A
CLP0412FPXX XZ03A	90-265Vac	12.0Vdc	37.5A	Negative Logic	5V@A	-40 to 85°C	Open with external airflow	CLP0412FPXXXZ03A
CLP0412FPXX XZ03A	75 – 130V <sub>RMS</sub> Trapezoidal Waveform	12.0Vdc	26.7A	Negative Logic	5V@A	-40 to 85°C	Enclosed with conduction cooling*	CLP0412FPXXXZ05A

\*Enclosure not provided with power supply. To be designed by user. Different OTP setting than open frame version.



---

**ABB**

601 Shiloh Rd.  
Plano, TX USA

**[Go.ABB/Industrial](#)**

We reserve the right to make technical changes or modify the contents of this document without prior notice. With regard to purchase orders, the agreed particulars shall prevail. ABB does not accept any responsibility whatsoever for potential errors or possible lack of information in this document.

We reserve all rights in this document and in the subject matter and illustrations contained therein. Any reproduction, disclosure to third parties or utilization of its contents – in whole or in parts – is forbidden without prior written consent of ABB.

Copyright© 2020 ABB  
All rights reserved