



Parameter	Rating	Units
Blocking Voltage	350	V <sub>p</sub>
Load Current	120	mA <sub>rms</sub> / mA <sub>DC</sub>
On-Resistance (max)	30	Ω
LED Current to operate	2	mA

### Features

- 1500V<sub>rms</sub> Input/Output Isolation
- Small 8-Pin SOIC Package
- No EMI/RFI Generation
- Immune to radiated EM fields
- Tape & Reel Version Available
- Flammability Rating UL 94 V-0

### Applications

- Telecommunication
- Security
  - Passive Infrared Detectors (PIR)
  - Data Signalling
  - Sensor Circuitry
- Instrumentation
- Multiplexers
- Data Acquisition
- Electronic Switching
- I/O Subsystems
- Medical Equipment—Patient/Equipment Isolation
- Industrial Controls

### Pin Configuration

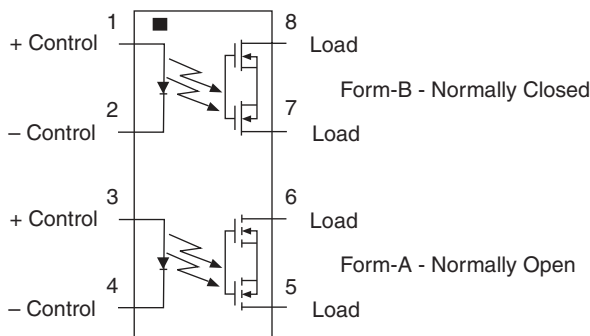

### Description

The CPC2330N is a miniature device with two independent solid state relays, one normally-open (1-Form-A) and the other normally-closed (1-Form-B), in an 8-pin SOIC package with 1500V<sub>rms</sub> of input to output isolation.

The optically coupled outputs, which use IXYS Integrated Circuits' patented OptoMOS architecture, are controlled by a highly efficient infrared LED.

Using IXYS Integrated Circuits' state of the art, double-molded vertical construction packaging, the CPC2330N is ideal for replacing larger, less-reliable reed and electromechanical relays.

### Approvals

- UL Recognized Component: File E76270
- TUV EN 62368-1: Certificate # B 082667 0008

### Ordering Information

Part #	Description
CPC2330N	8-Pin SOIC (50/tube)
CPC2330NTR	8-Pin SOIC (2000/reel)

Switching Characteristics of Normally-Open Devices

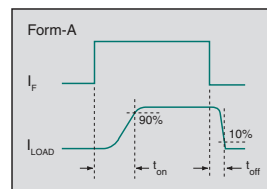

Switching Characteristics of Normally-Closed Devices

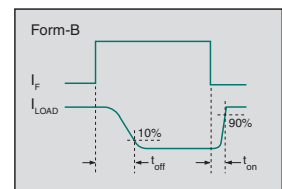

### Absolute Maximum Ratings @ 25°C

Parameter	Ratings	Units
Blocking Voltage	350	V <sub>P</sub>
Reverse Input Voltage	5	V
Input Control Current Peak (10ms)	50	mA
	1	A
Total Power Dissipation <sup>1</sup>	600	mW
Isolation Voltage, Input to Output	1500	V <sub>rms</sub>
ESD Rating, Human Body Model	8	kV
Operational Temperature, Ambient	-40 to +85	°C
Storage Temperature	-40 to +125	°C
Soldering Temperature (10 Seconds)	260	°C

<sup>1</sup> Derate linearly 5mW / °C

Absolute Maximum Ratings are stress ratings. Stresses in excess of these ratings can cause permanent damage to the device. Functional operation of the device at conditions beyond those indicated in the operational sections of this data sheet is not implied.

Typical values are characteristic of the device at +25°C, and are the result of engineering evaluations. They are provided for information purposes only, and are not part of the manufacturing testing requirements.

### Electrical Characteristics @ 25°C

Parameter	Conditions	Symbol	Min	Typ	Max	Units
<b>Output Characteristics</b>						
Blocking Voltage	I <sub>L</sub> =1μA	V <sub>DRM</sub>	350	-	-	V
Load Current Form-A, Continuous <sup>1</sup> Form-B, Continuous <sup>1</sup> Peak	I <sub>F</sub> =2mA	I <sub>L</sub>	-	-	120	mA <sub>rms</sub> / mA <sub>DC</sub>
	I <sub>F</sub> =0mA					
	t=10ms	I <sub>LPK</sub>	-	-	±350	mA <sub>P</sub>
On-Resistance <sup>2</sup>	I <sub>L</sub> =120mA	R <sub>ON</sub>	-	-	30	Ω
<b>Switching Speeds</b>						
Turn-On Turn-Off	I <sub>F</sub> =5mA, V <sub>L</sub> =10V	t <sub>on</sub>	-	-	3	ms
		t <sub>off</sub>	-	-	3	
<b>Off-State Leakage Current</b>						
Form-A Form-B	I <sub>F</sub> =0mA, V <sub>L</sub> =350V <sub>P</sub>	I <sub>LEAK</sub>	-	0.001	1	μA
	I <sub>F</sub> =2mA, V <sub>L</sub> =350V <sub>P</sub>		-	2	5	
<b>Output Capacitance</b>						
Form-A Form-B	I <sub>F</sub> =0mA, V <sub>L</sub> =50V, f=1MHz	C <sub>OUT</sub>	-	9	-	pF
	I <sub>F</sub> =2mA, V <sub>L</sub> =50V, f=1MHz			6		
<b>Input Characteristics</b>						
Input Control Current to Activate <sup>3</sup>	I <sub>L</sub> =120mA	I <sub>F</sub>	-	-	2	mA
Input Control Current to Deactivate	-	I <sub>F</sub>	0.1	-	-	mA
Input Voltage Drop	I <sub>F</sub> =5mA	V <sub>F</sub>	0.9	1.36	1.5	V
Reverse Input Current	V <sub>R</sub> =5V	I <sub>R</sub>	-	-	10	μA
<b>Common Characteristics</b>						
Capacitance, Input to Output	V <sub>IO</sub> =0V, f=1MHz	C <sub>IO</sub>	-	1	-	pF

<sup>1</sup> Load current derates linearly from 120mA @ 25°C to 60mA @ 85°C, and must be derated for both poles operating simultaneously.

<sup>2</sup> Measurement taken within 1 second of on-time.

<sup>3</sup> For applications requiring high temperature operation (greater than 60°C) a minimum LED drive current of 4mA is recommended.

**Common Performance Data\***

**Typical LED Forward Voltage Drop  
(N=50, I<sub>F</sub>=5mA)**

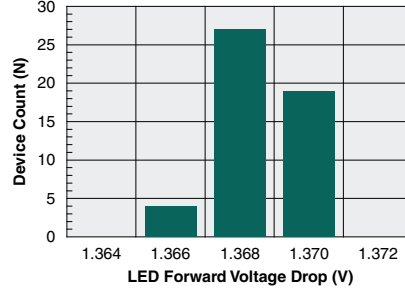

**Typical LED Forward Voltage Drop vs. Temperature**

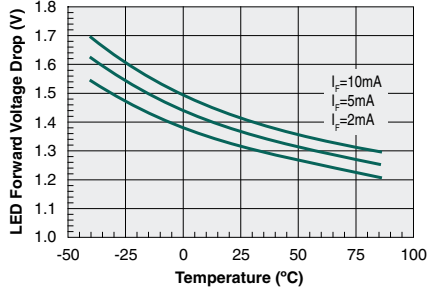

**Maximum Load Current vs. Temperature**

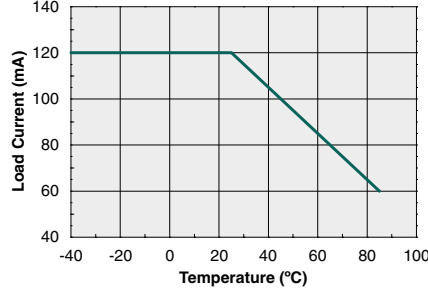

**Energy Rating Curve**

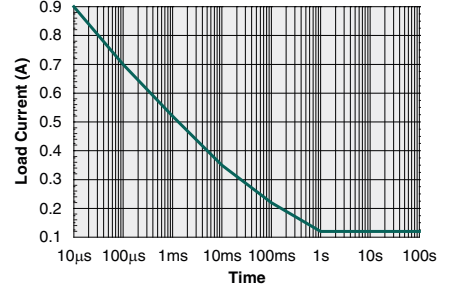

**FORM-A Performance Data\***

**Typical I<sub>F</sub> for Switch Operation  
(N=50, I<sub>L</sub>=120mA)**

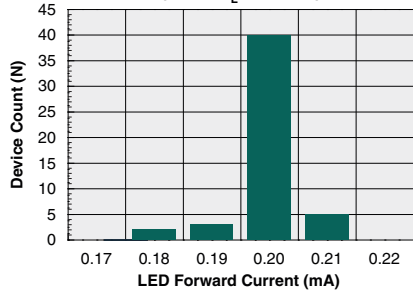

**Typical Turn-On Time  
(N=50, I<sub>F</sub>=5mA, I<sub>L</sub>=60mA)**

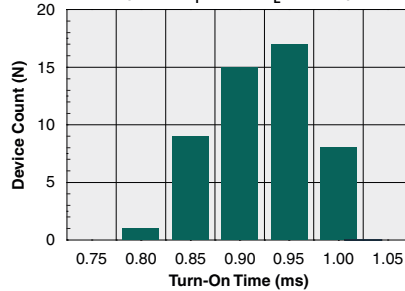

**Typical Turn-Off Time  
(N=50, I<sub>F</sub>=5mA, I<sub>L</sub>=60mA)**

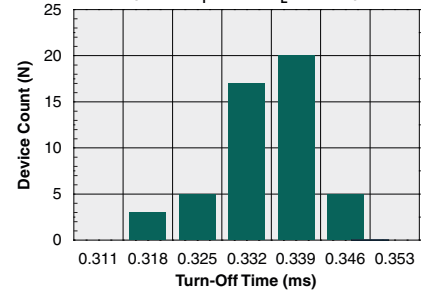

**Typical On-Resistance Distribution  
(N=50, I<sub>F</sub>=2mA, I<sub>L</sub>=120mA)**

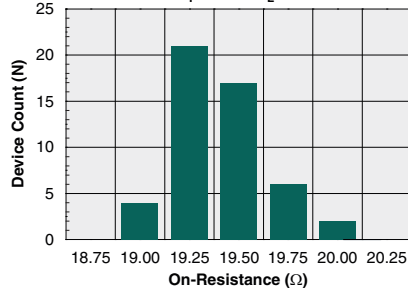

**Typical Blocking Voltage Distribution  
(N=50, I<sub>F</sub>=0mA)**

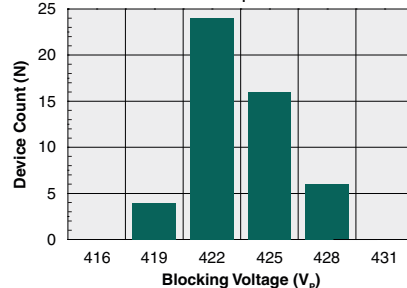

\*Unless otherwise noted, data presented in these graphs is typical of device operation at 25°C.

FORM-A Performance Data (Cont.)\*

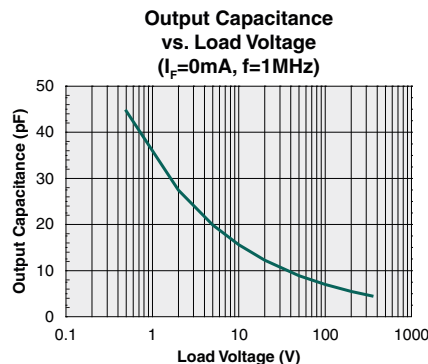
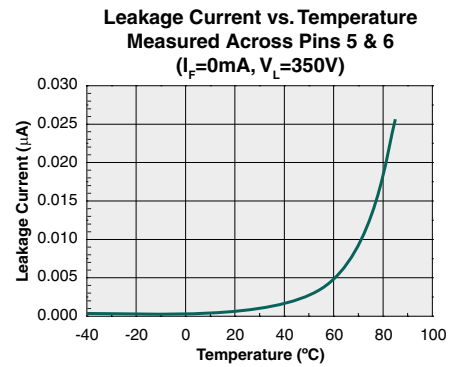
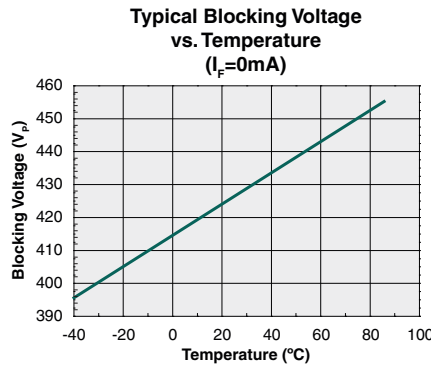
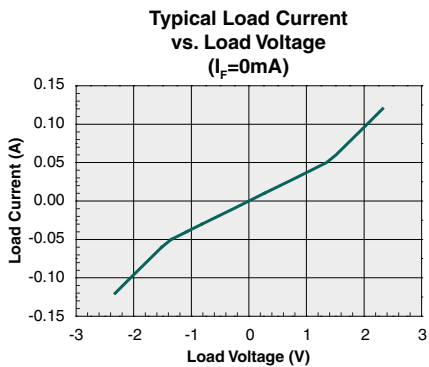
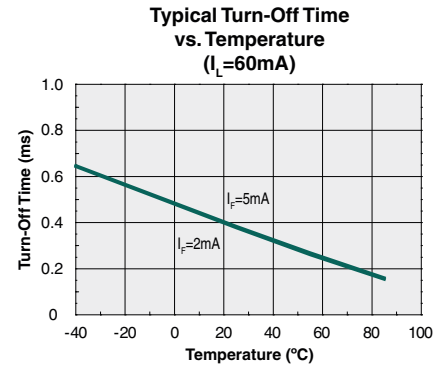
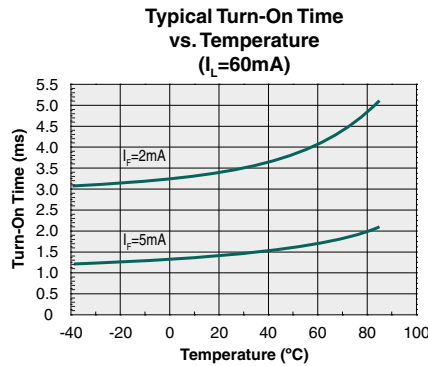
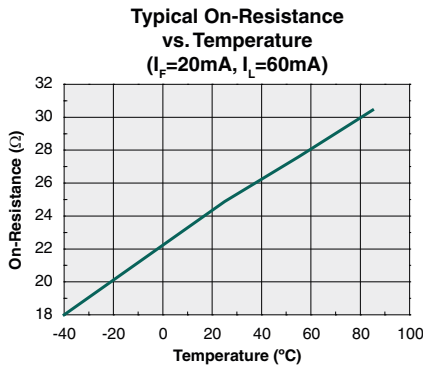
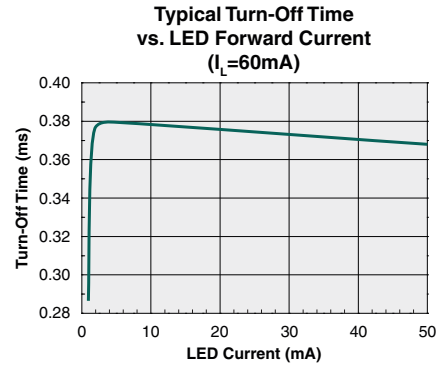
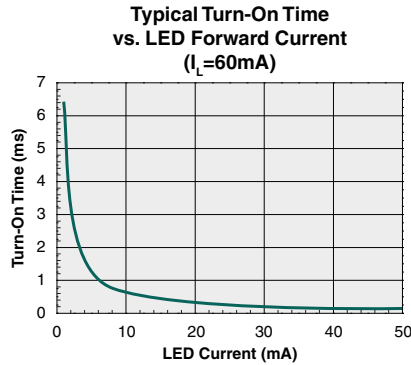
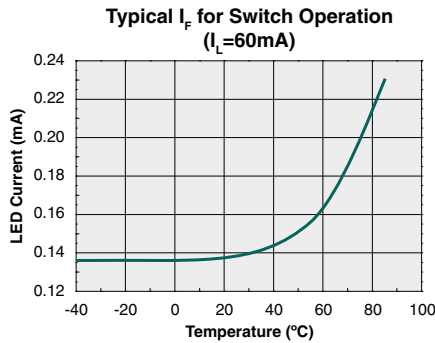

\*Unless otherwise noted, data presented in these graphs is typical of device operation at 25°C.

**FORM-B Performance Data\***

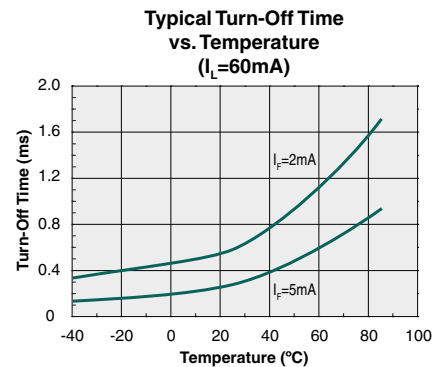
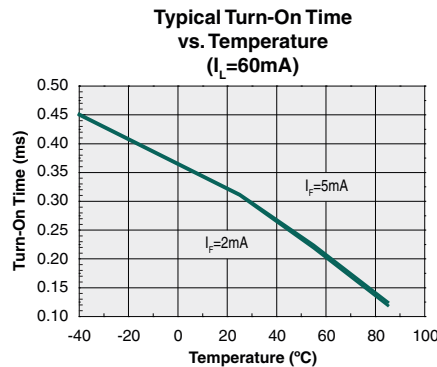
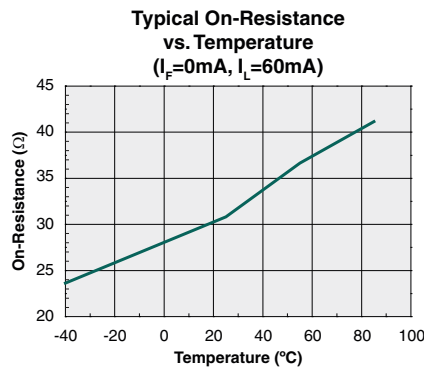
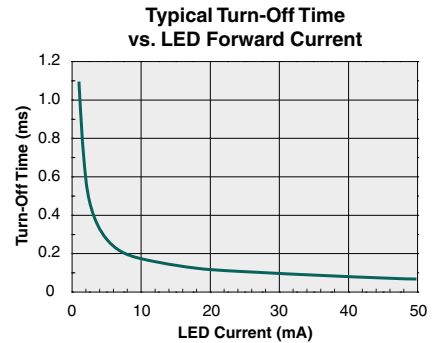
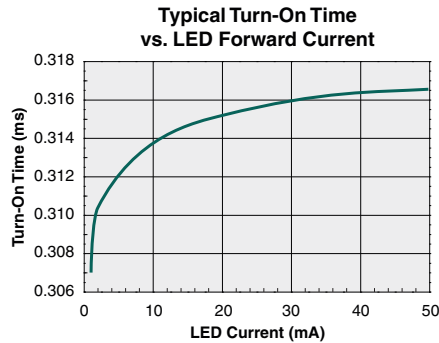
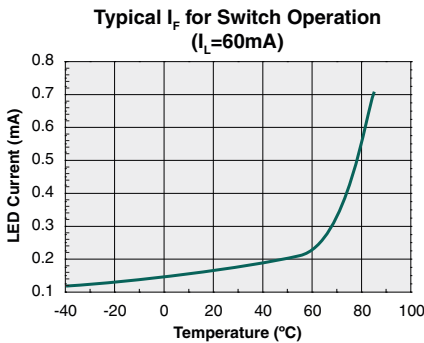
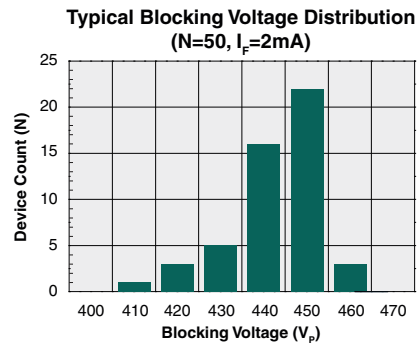
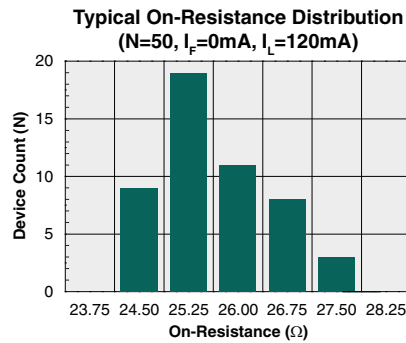
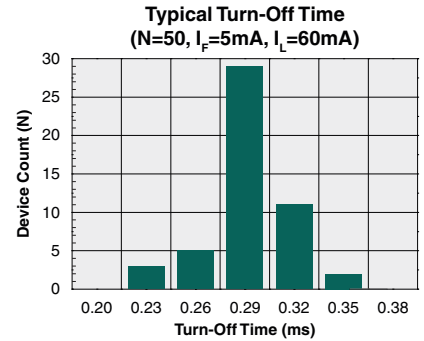
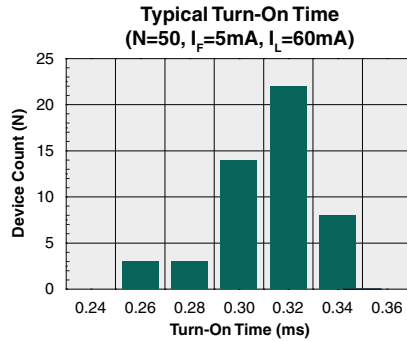
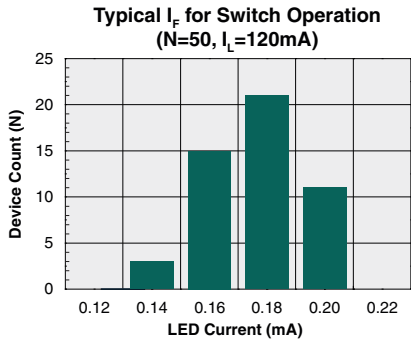

\*Unless otherwise noted, data presented in these graphs is typical of device operation at 25°C.

**FORM-B PERFORMANCE DATA (Cont.)\***

**Typical Load Current vs. Load Voltage**  
( $I_F=0mA$ )

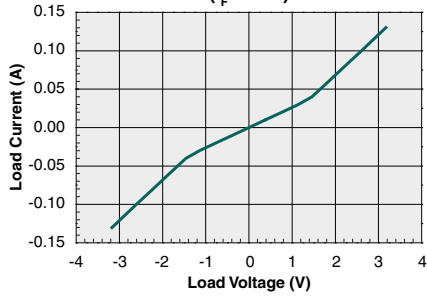

**Typical Blocking Voltage vs. Temperature**  
( $I_F=5mA$ )

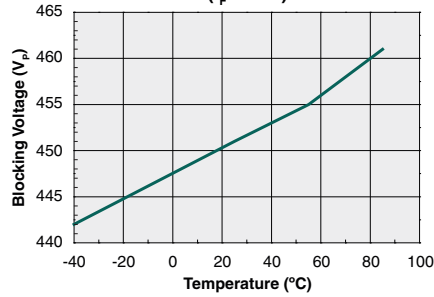

**Leakage Current vs. Temperature Measured Across Pins 7 & 8**  
( $I_F=2mA, V_L=350V$ )

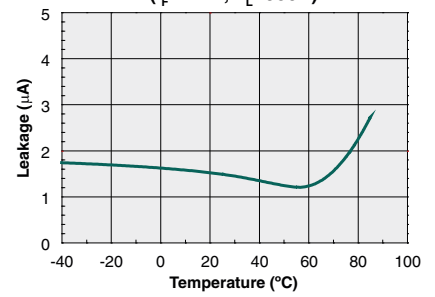

**Output Capacitance vs. Load Voltage**  
( $I_F=2mA, f=1MHz$ )

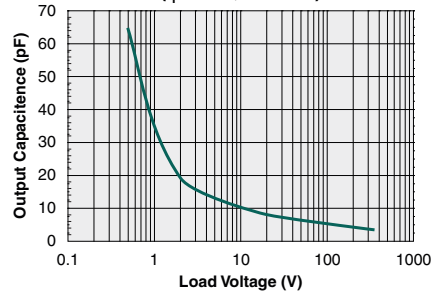

\*Unless otherwise noted, data presented in these graphs is typical of device operation at 25°C.

## Manufacturing Information

### Moisture Sensitivity



All plastic encapsulated semiconductor packages are susceptible to moisture ingress. IXYS Integrated Circuits classifies its plastic encapsulated devices for moisture sensitivity according to the latest version of the joint industry standard, **IPC/JEDEC J-STD-020**, in force at the time of product evaluation. We test all of our products to the maximum conditions set forth in the standard, and guarantee proper operation of our devices when handled according to the limitations and information in that standard as well as to any limitations set forth in the information or standards referenced below.

Failure to adhere to the warnings or limitations as established by the listed specifications could result in reduced product performance, reduction of operable life, and/or reduction of overall reliability.

This product carries a **Moisture Sensitivity Level (MSL)** classification as shown below, and should be handled according to the requirements of the latest version of the joint industry standard **IPC/JEDEC J-STD-033**.

Device	Moisture Sensitivity Level (MSL) Classification
CPC2330N	MSL 3

### ESD Sensitivity



This product is ESD Sensitive, and should be handled according to the industry standard **JESD-625**.

### Soldering Profile

Provided in the table below is the **IPC/JEDEC J-STD-020** Classification Temperature ( $T_C$ ) and the maximum dwell time the body temperature of these surface mount devices may be ( $T_C - 5$ )°C or greater. The Classification Temperature sets the Maximum Body Temperature allowed for these devices during reflow soldering processes.

Device	Classification Temperature ( $T_C$ )	Dwell Time ( $t_p$ )	Max Reflow Cycles
CPC2330N	260°C	30 seconds	3

### Board Wash

IXYS Integrated Circuits recommends the use of no-clean flux formulations. Board washing to reduce or remove flux residue following the solder reflow process is acceptable provided proper precautions are taken to prevent damage to the device. These precautions include but are not limited to: using a low pressure wash and providing a follow up bake cycle sufficient to remove any moisture trapped within the device due to the washing process. Due to the variability of the wash parameters used to clean the board, determination of the bake temperature and duration necessary to remove the moisture trapped within the package is the responsibility of the user (assembler). Cleaning or drying methods that employ ultrasonic energy may damage the device and should not be used. Additionally, the device must not be exposed to halide flux or solvents.



### Mechanical Dimensions

#### CPC2330N

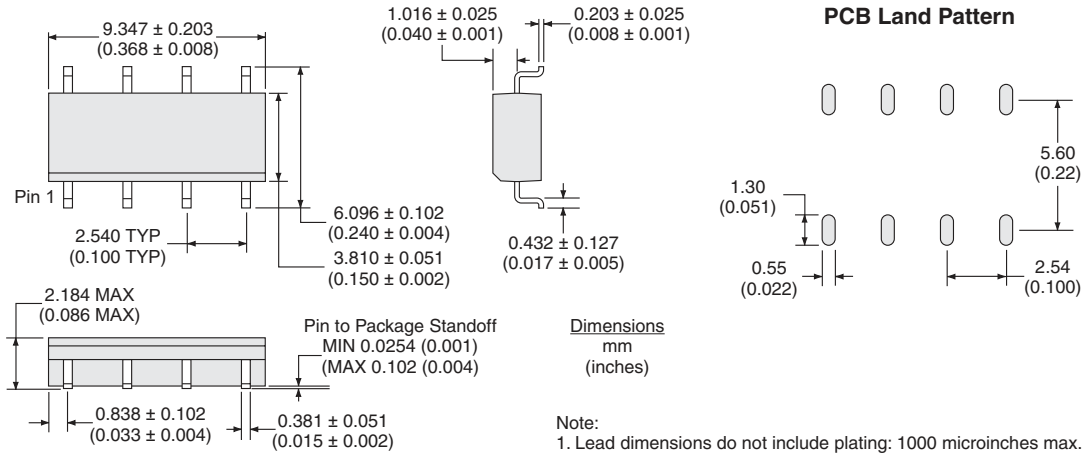

#### CPC2330NTR Tape & Reel

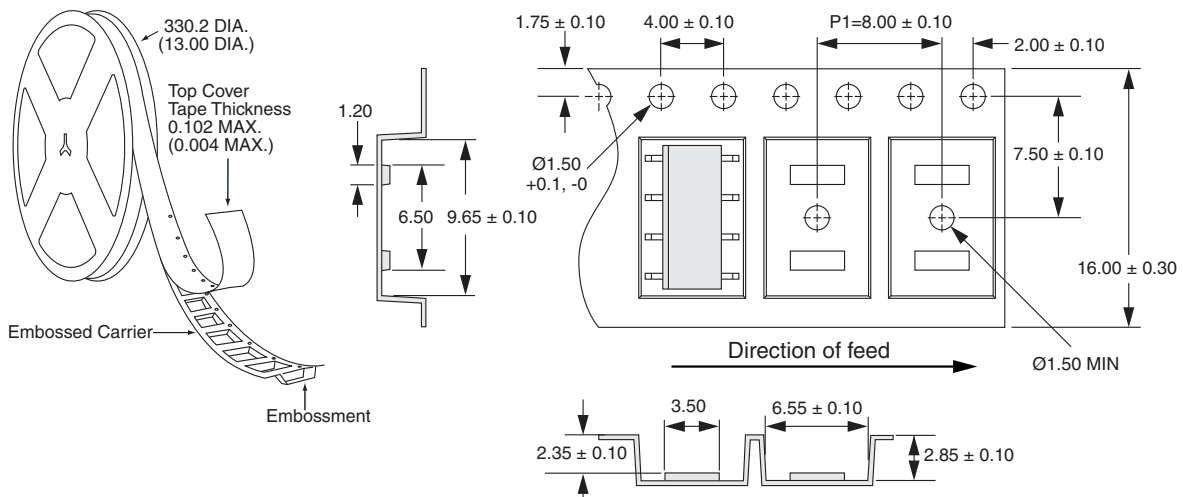

- NOTES:
1. All dimensions in millimeters
  2. 10 sprocket hole pitch cumulative tolerance  $\pm 0.20$ .
  3. Carrier camber is within 1mm in 250mm.
  4. Tape material : Black Conductive Polystyrene Alloy.
  5. All dimensions meet EIA-481-C requirements.
  6. Thickness : 0.30  $\pm$  0.05mm.

For additional information please visit our website at: <https://www.ixysic.com>