

| | | |
|---|---|-------|
| GlobTek, Inc. www.globtek.com 186 Veterans Drive, Northvale, NJ 07647 Tel. (201) 784-1000 Fax (201) 784-0111 | Drawing Title: GTM961800P18024-T2, Medical/ICT/ITE/Household use Power Supply, Efficiency Level: USA DOE Level VI / Eco-design Directive 2009/125/EC, (EU) 2019/1782, Case Color/Style: GlobTek Black, Desktop/External, Regulated Switchmode AC-DC Power Supply AC Adaptor, Input Rating: 100-240V~, 50-60 Hz, IEC 60320/C8 , Output Rating: 180W, 24.0V@7.5A, Output Configuration: 1200 mm, 16 (Large ground 40/0.20) OD:4.3mm/1C + Shield Cond, UL 1185, 4 Pin Kycon Snap and Lock Plug KPP-4P, NO equal, Male contacts, Ferrite: None, GlobTek Black, GT Cord # C21419, Pin Out: Pin 2,4: +V, Pin 1,3, Shell: -V, Blades/Input Cord: (Order Separately), Approvals: CB 60601-1-11; CB 60601-1; S-Mark IEC/EN 60601-1; cETLus; EAC; CB 60950; CB 60335; cETLus 60601-1 3rd; RCM; UKCA; Conforms to 62368-1; CCC; CB 62368; S-Mark 60950; cETLus 60950-1; cETLus 60601-1-11; cETLus 60950-1; ETL 62368; Morocco; IRAM; FCC; HKSM; PSE; CE; China RoHS; Double Insulation; PSE; PSE; Level VI; RoHS; Ukraine; VCCI; WEEE; | |
| | Model No. GTM961800P18024-T2 | |
| | Part No./Ordering No. TR9KI7500YL4IMR6B | Rev A |

In Addition to GlobTek Inc.'s renewed ISO9001:2015 - Quality Management System Certification, GlobTek Inc. is now certified to:

ISO13485:2016 - Medical Devices Quality Management System Certification

ISO14001:2015 - Environmental Management System Certification

ISO Certificates are available online at <https://www.globtek.com/iso-certificates/>

The acceptance of this specification and use of the product described in this document indicates the acceptance and binding of the customer to Globtek TERMS AND CONDITIONS (attached to the end of this document), which supersede all other agreements, terms, and conditions (<https://en.globtek.com/terms-and-conditions/>).

The purchaser of this product (Customer) agrees that it is their sole responsibility to determine suitability/fitness of the product described in this specification for their application and to take precautions for protection against any hazards attendant to the handling and use of the product.

Footnote:

GlobTek Inc. will not be liable for the safety and performance of these power supplies/battery packs if unauthorized access and repair occurs. End user should consult applicable UL, CSA or EN standards for proper installation instruction.

Limitation of Use:

GlobTek products are intended for use with commercial, medical, and/or industrial equipment only. GlobTek product are not authorized for use as mission critical components in life support hazardous environment, nuclear or aircraft applications without prior written approval from the CEO of GlobTek Inc.

Contents of this document are subject to change without prior notice.

Customer Approval of Specification:

Please approve, sign and send back to GlobTek so we can complete order processing.

A delay in receipt of this form will delay delivery schedule.

| | |
|---------------------------------------|--|
| Company Name: _____ | Customer P/N: _____ |
| Quote Number: _____ | Date: _____ |
| Authorized Representative Name: _____ | Authorized Representative Signature: _____ |

| | | |
|---|---|-------|
| GlobTek, Inc. www.globtek.com 186 Veterans Drive, Northvale, NJ 07647 Tel. (201) 784-1000 Fax (201) 784-0111 | Drawing Title: GTM961800P18024-T2, Medical/ICT/ITE/Household use Power Supply, Efficiency Level: USA DOE Level VI / Eco-design Directive 2009/125/EC, (EU) 2019/1782, Case Color/Style: GlobTek Black, Desktop/External, Regulated Switchmode AC-DC Power Supply AC Adaptor, Input Rating: 100-240V~, 50-60 Hz, IEC 60320/C8 , Output Rating: 180W, 24.0V@7.5A, Output Configuration: 1200 mm, 16 (Large ground 40/0.20) OD:4.3mm/1C + Shield Cond, UL 1185, 4 Pin Kycon Snap and Lock Plug KPP-4P, NO equal, Male contacts, Ferrite: None, GlobTek Black, GT Cord # C21419, Pin Out: Pin 2,4: +V, Pin 1,3, Shell: -V, Blades/Input Cord: (Order Separately), Approvals: CB 60601-1-11; CB 60601-1; S-Mark IEC/EN 60601-1; cETLus; EAC; CB 60950; CB 60335; cETLus 60601-1 3rd; RCM; UKCA; Conforms to 62368-1; CCC; CB 62368; S-Mark 60950; cETLus 60950-1; cETLus 60601-1-11; cETLus 60950-1; ETL 62368; Morocco; IRAM; FCC; HKSM; PSE; CE; China RoHS; Double Insulation; PSE; PSE; Level VI; RoHS; Ukraine; VCCI; WEEE; | |
| | Model No. GTM961800P18024-T2 | |
| | Part No./Ordering No. TR9KI7500YL4IMR6B | Rev A |

REVISION HISTORY

| REV | DESCRIPTION | SUB | DATE | APPROVED |
|-----|-----------------|-----|------------|----------|
| A | Initial release | QA | 06/18/2018 | QA |

POWER SUPPLY INFORMATION

| | |
|--------------------------------|---|
| TYPE | Desktop/External |
| TECHNOLOGY | Regulated Switchmode AC-DC Power Supply AC Adaptor |
| CASE COLOR | GlobTek Black |
| NAMEPLATE RATED INPUT | 100-240V~, 50-60 Hz, 2.2A |
| INPUT CONFIG | IEC 60320/C8 |
| WATTS | 180.00 |
| VOLTS OUT | 24.0 |
| CURRENT OUT (Amps) | 7.5 |
| BLADE/CORD INCLUDED | None (Order Separately) |
| BLADE/CORD INSTALLED | None :(Order Separately) |
| INGRESS PROTECTION | IP41 |
| GROUNDING CONFIGURATION | (F1) Class II / Double Insulated |
| EFFICIENCY LEVEL | USA DOE Level VI / Eco-design Directive 2009/125/EC, (EU) 2019/1782 |
| OUTPUT CONFIGURATION | 1200 mm, 16 (Large ground 40/0.20) OD:4.3mm/1C + Shield Cond, UL 1185, 4 Pin Kycon Snap and Lock Plug KPP-4P, NO equal, Male contacts, Ferrite: None, GlobTek Black, GT Cord # C21419 |
| OVERMOLDED | Yes |
| CONNECTOR PIN OUT | Pin 2,4: +V, Pin 1,3, Shell: -V |
| LABEL SPECS | Standard GT,L-1186 |
| SPECIAL BARCODE LABEL MATERIAL | No |
| PACK SPEC | Standard DT, Cellular packaging, User manual |
| USER MANUAL | 809-DESKTOPUSERMANUAL on A4 paper |

PROPRIETARY INFORMATION

PROPRIETARY OF GLOBTEK, INC. ANY REPRODUCTION, DISCLOSURE OR USE OF THIS DRAWING, IN WHOLE OR IN PART, IS HEREBY PROHIBITED EXCEPT AS SPECIFIED IN WRITING BY GLOBTEK, INC. © GlobTek, Inc. 2018 - 2023

| | | |
|---|---|-------|
| GlobTek, Inc. www.globtek.com 186 Veterans Drive, Northvale, NJ 07647 Tel. (201) 784-1000 Fax (201) 784-0111 | Drawing Title: GTM961800P18024-T2, Medical/ICT/ITE/Household use Power Supply, Efficiency Level: USA DOE Level VI / Eco-design Directive 2009/125/EC, (EU) 2019/1782, Case Color/Style: GlobTek Black, Desktop/External, Regulated Switchmode AC-DC Power Supply AC Adaptor, Input Rating: 100-240V~, 50-60 Hz, IEC 60320/C8 , Output Rating: 180W, 24.0V@7.5A, Output Configuration: 1200 mm, 16 (Large ground 40/0.20) OD:4.3mm/1C + Shield Cond, UL 1185, 4 Pin Kycon Snap and Lock Plug KPP-4P, NO equal, Male contacts, Ferrite: None, GlobTek Black, GT Cord # C21419, Pin Out: Pin 2,4: +V, Pin 1,3, Shell: -V, Blades/Input Cord: (Order Separately), Approvals: CB 60601-1-11; CB 60601-1; S-Mark IEC/EN 60601-1; cETLus; EAC; CB 60950; CB 60335; cETLus 60601-1 3rd; RCM; UKCA; Conforms to 62368-1; CCC; CB 62368; S-Mark 60950; cETLus 60950-1; cETLus 60601-1-11; cETLus 60950-1; ETL 62368; Morocco; IRAM; FCC; HKSM; PSE; CE; China RoHS; Double Insulation; PSE; PSE; Level VI; RoHS; Ukraine; VCCI; WEEE; | |
| | Model No. GTM961800P18024-T2 | |
| | Part No./Ordering No. TR9KI7500YL4IMR6B | Rev A |

Notes/Modifications/Customizations (notes in this section supersede the values shown in the standard spec)

DIMENSIONS ARE IN MM UNLESS SPECIFIED OTHERWISE

| | | |
|---|---|-------|
| GlobTek, Inc. www.globtek.com 186 Veterans Drive, Northvale, NJ 07647 Tel. (201) 784-1000 Fax (201) 784-0111 | Drawing Title: GTM961800P18024-T2, Medical/ICT/ITE/Household use Power Supply, Efficiency Level: USA DOE Level VI / Eco-design Directive 2009/125/EC, (EU) 2019/1782, Case Color/Style: GlobTek Black, Desktop/External, Regulated Switchmode AC-DC Power Supply AC Adaptor, Input Rating: 100-240V~, 50-60 Hz, IEC 60320/C8 , Output Rating: 180W, 24.0V@7.5A, Output Configuration: 1200 mm, 16 (Large ground 40/0.20) OD:4.3mm/1C + Shield Cond, UL 1185, 4 Pin Kycon Snap and Lock Plug KPP-4P, NO equal, Male contacts, Ferrite: None, GlobTek Black, GT Cord # C21419, Pin Out: Pin 2,4: +V, Pin 1,3, Shell: -V, Blades/Input Cord: (Order Separately), Approvals: CB 60601-1-11; CB 60601-1; S-Mark IEC/EN 60601-1; cETLus; EAC; CB 60950; CB 60335; cETLus 60601-1 3rd; RCM; UKCA; Conforms to 62368-1; CCC; CB 62368; S-Mark 60950; cETLus 60950-1; cETLus 60601-1-11; cETLus 60950-1; ETL 62368; Morocco; IRAM; FCC; HKSM; PSE; CE; China RoHS; Double Insulation; PSE; PSE; Level VI; RoHS; Ukraine; VCCI; WEEE; | |
| | Model No. GTM961800P18024-T2 | |
| | Part No./Ordering No. TR9KI7500YL4IMR6B | Rev A |

ELECTRICAL SPECIFICATIONS

Input

| | |
|----------------------|--|
| Input Voltage: | Specified: 90-264VAC, Nameplate: 100-240VAC 100% rated load current for 90-264VAC 90% rated load current for 85-264VAC |
| Input Frequency: | Specified: 47-63Hz, Nameplate: 50-60Hz |
| Power Factor: | 0.90 (min.) @ 230VAC, 0.97 (min.) @ 115VAC |
| No Load Input Power: | <150mW @ 230VAC (EU CoC Tier 2 compliant) |
| Inrush Current: | 30A/60A max. (cold start @ 115V/230VAC) |
| Efficiency: | DoE Level VI and EU CoC Tier 2 compliant |

Output

| | |
|----------------------|--|
| Turn-on Delay: | 1 second typ. @ 115VAC and full load |
| Output Regulation: | ± 4% (measured at output connector) |
| Line Regulation: | ± 0.5% typ. (measured at output connector, full load) |
| Ripple: | 1% or 200mV, whichever is greater (using a 47µF low-ESR cap + 0.1µF ceramic capacitor, measured @ 20MHz BW, at output connector) |
| Turn-On Overshoot: | 5% max. |
| Transient Response: | 5% max. deviation, 1ms recovery time (with 25% to 50% load step) |
| Hold-up Time: | 20ms min. |
| Switching Frequency: | 25 - 125KHz, depending on model and load condition |
| Power Indicator: | Green LED |

Protections

| | |
|---------------------------|--|
| Input Protection: | MOV transient suppressor, dual input line fusing |
| Over-Current Protection: | 105 - 140% of rated output current, auto-restart |
| Short-Circuit Protection: | Auto-restart |
| Over-Voltage Protection: | 110 - 135% (60V max. for output voltage ≥ 45V), latched off, cycle AC to reset |

Environmental

| | |
|------------------------|---|
| MTBF: | 1,500,000 hours @ 25°C ambient, full load (Telcordia SR-332, Issue 3) |
| Operating Temperature: | -10°C to 40°C (full load) |
| Storage Temperature: | -30°C to 80°C |
| Humidity: | 0% to 95% relative humidity, non-condensing |
| Altitude: | 5000m |
| Cooling: | Convection |

PROPRIETARY INFORMATION

PROPRIETARY OF GLOBTEK, INC. ANY REPRODUCTION, DISCLOSURE OR USE OF THIS DRAWING, IN WHOLE OR IN PART, IS HEREBY PROHIBITED EXCEPT AS SPECIFIED IN WRITING BY GLOBTEK, INC. © GlobTek, Inc. 2018 - 2023

| | | |
|---|--|-------|
| GlobTek, Inc. www.globtek.com 186 Veterans Drive, Northvale, NJ 07647 Tel. (201) 784-1000 Fax (201) 784-0111 | Drawing Title: GTM961800P18024-T2, Medical/ICT/ITE/Household use Power Supply, Efficiency Level: USA DOE Level VI / Eco-design Directive 2009/125/EC, (EU) 2019/1782, Case Color/Style: GlobTek Black, Desktop/External, Regulated Switchmode AC-DC Power Supply AC Adaptor, Input Rating: 100-240V~, 50-60 Hz, IEC 60320/C8, Output Rating: 180W, 24.0V@7.5A, Output Configuration: 1200 mm, 16 (Large ground 40/0.20) OD:4.3mm/1C + Shield Cond, UL 1185, 4 Pin Kycon Snap and Lock Plug KPP-4P, NO equal, Male contacts, Ferrite: None, GlobTek Black, GT Cord # C21419, Pin Out: Pin 2,4: +V, Pin 1,3, Shell: -V, Blades/Input Cord: (Order Separately), Approvals: CB 60601-1-11; CB 60601-1; S-Mark IEC/EN 60601-1; cETLus; EAC; CB 60950; CB 60335; cETLus 60601-1 3rd; RCM; UKCA; Conforms to 62368-1; CCC; CB 62368; S-Mark 60950; cETLus 60950-1; cETLus 60601-1-11; cETLus 60950-1; ETL 62368; Morocco; IRAM; FCC; HKSM; PSE; CE; China RoHS; Double Insulation; PSE; PSE; Level VI; RoHS; Ukraine; VCCI; WEEE; | |
| | Model No. GTM961800P18024-T2 | |
| | Part No./Ordering No. TR9KI7500YL4IMR6B | Rev A |

| | |
|---------|--|
| RoHS: | Complies with EU 2011/65/EU and China SJ/T 11363-2006 |
| Note 1: | Regarding operating temperature a. See below de-rating table for output power capability at alternate temperature b. Extended low-end temperature range available as a custom option |

Safety

| | |
|-------------------------------|--|
| Dielectric Withstand Voltage: | 4000VAC or 5656VDC from input to output 3000VAC or 4242VDC from input to earth (Class I models only) |
| Touch Current: | Standard models (No suffix): Class I: 20µA max. Class II: 70µA max. Class II with Functional Earth (F2): 20µA max. Low-leakage models (-CF suffix): Class II with Functional Earth (F2): 10µA max. |
| Note 2: | Standard models are designed for use in Type-B/BF medical applications. Low-leakage models are designed for use in Type-CF medical applications. (See IEC60601-1, Clause 16.6.1) |
| Earth Leakage Current | Class I: 300µA max. Class II: N/A |
| Means of Protection: | 2 x MOPP |
| Output Isolation Options: | Class I: C6 or C14 inlet (output negative tied to Earth contact) Class II: C8 or C18 inlet Class II FE: C6 or C14 inlet (output isolated from Earth contact) Review isolation options by reading our white paper PSU Isolation and Identity . |
| Earth Continuity Test: | < 0.1Ω between earth pin (on AC inlet) and PCB termination point (Class I models only) |
| Compliant Standards: | See listing at end of this datasheet for specific standards |

EMC

| | |
|--|--|
| Applicable Standards: | Medical: EN60601-1-2, 4th edition Emissions: EN55032, EN61000-6-3, EN61000-6-4, CISPR11, CISPR22 Immunity: EN55024, EN61000-6-1, EN61000-6-2 |
| Conducted Emissions: | Class B, FCC Part 15, Class B (with resistive load) |
| Radiated Emissions: | Class B, FCC Part 15, Class B (with resistive load) |
| Harmonic Current Voltage Distortion: | EN61000-3-2, Class A |
| Voltage Fluctuations/Flicker: | EN61000-3-3 |
| Electrostatic Discharge (ESD) Immunity: | EN61000-4-2, 10KV contact discharge, 18KV air discharge |
| Radiated RF Immunity: | EN61000-4-3, 10V/m 80-2700MHz, 80% 1KHz AM |
| EFT/Burst Immunity: | EN61000-4-4, 4KV/100kHz. |
| Line Surge Immunity: | EN61000-4-5, 2KV differential, 4KV common-mode |
| Conducted RF Immunity: | EN61000-4-6, 3VRMS, 80% 1KHz AM |
| Power Frequency Magnetic Field Immunity: | EN61000-4-8, 3A/m |

PROPRIETARY INFORMATION

PROPRIETARY OF GLOBTEK, INC. ANY REPRODUCTION, DISCLOSURE OR USE OF THIS DRAWING, IN WHOLE OR IN PART, IS HEREBY PROHIBITED EXCEPT AS SPECIFIED IN

WRITING BY GLOBTEK, INC. © GlobTek, Inc. 2018 - 2023

quest / 08/02/2023 6:21:24 PM GMT CLONED FROM TR9CI6666MF6C1MR6B

| | | |
|---|---|--------------|
| <p>GlobTek, Inc. www.globtek.com 186 Veterans Drive, Northvale, NJ 07647 Tel. (201) 784-1000 Fax (201) 784-0111</p> | <p>Drawing Title: GTM961800P18024-T2, Medical/ICT/ITE/Household use Power Supply, Efficiency Level: USA DOE Level VI / Eco-design Directive 2009/125/EC, (EU) 2019/1782, Case Color/Style: GlobTek Black, Desktop/External, Regulated Switchmode AC-DC Power Supply AC Adaptor, Input Rating: 100-240V~, 50-60 Hz, IEC 60320/C8, Output Rating: 180W, 24.0V@7.5A, Output Configuration: 1200 mm, 16 (Large ground 40/0.20) OD:4.3mm/1C + Shield Cond, UL 1185, 4 Pin Kycon Snap and Lock Plug KPP-4P, NO equal, Male contacts, Ferrite: None, GlobTek Black, GT Cord # C21419, Pin Out: Pin 2,4: +V, Pin 1,3, Shell: -V, Blades/Input Cord: (Order Separately), Approvals: CB 60601-1-11; CB 60601-1; S-Mark IEC/EN 60601-1; cETLus; EAC; CB 60950; CB 60335; cETLus 60601-1 3rd; RCM; UKCA; Conforms to 62368-1; CCC; CB 62368; S-Mark 60950; cETLus 60950-1; cETLus 60601-1-11; cETLus 60950-1; ETL 62368; Morocco; IRAM; FCC; HKSM; PSE; CE; China RoHS; Double Insulation; PSE; PSE; Level VI; RoHS; Ukraine; VCCI; WEEE;</p> | |
| | <p>Model No. GTM961800P18024-T2</p> | |
| | <p>Part No./Ordering No. TR9KI7500YL4IMR6B</p> | <p>Rev A</p> |

Voltage Dip Immunity: EN61000-4-11

Enclosure

Material/Construction: High impact plastic, 94V0 polycarbonate, non-vented

Size: 176.5 * 74.0 * 40.0mm (±1.0mm)

AC Input Mechanical Options: Desktop: C6, C7, C14, or C18 inlet

Markings: Label and/or pad printed and/or laser-etched into case

Special Options

1. Custom cordsets, cord types, and connector types
2. Custom markings
3. Custom housing and cordset colors
4. Constant current/constant voltage (CC/CV) output behavior, with compliance voltage between (75% * Vout) and (100% * Vout)
5. Short term output surge power capability, for motor applications and short term intermittent high power applications. (Up to 300W for 1 second.)
6. IEC61000-3-2 Class C line harmonics for LED lighting applications
7. "Back EMF" upgrade, for motor loads and other high inductance applications with reverse energy flow requirements
8. Reduced touch/leakage current for IEC60601-1 Type-CF applications. (Available in models with -CF suffix.)
9. High reliability PCB laminate with plated through-holes for IPC610 Class 2 compliance
10. Tightened output voltage tolerance
11. Reduced output ripple level
12. Reduced output power rating
13. Improved ingress protection (IP) rating

Output Connectors

- Several output connector options are available with various output current ratings. GlobTek can supply 10A rated 2.1mm and 2.5mm style DC Power Jacks, to complement our 10A output rated 2.1mm and 2.5mm DC power plugs used on our output cordsets.
- Please visit our real-time listing of mating connector product offering:
<https://en.globtek.com/news/high-current-coaxial-barrel-plug-jacks-for-high-wattage-power-supplies>

TO ADDRESS SYSTEM-LEVEL EMI CONCERNS, FERRITE CHOKES/BEADS MAY BE ADDED/REVISED UPON REQUEST. A SAMPLE KIT OF GLOBTEK'S STANDARD FERRITES IS AVAILABLE UNDER GLOBTEK P/N: EMI-MITIGATION-KIT1

FOR ADDITIONAL INFORMATION, PLEASE READ OUR WHITE PAPER AT: <https://r.globtek.info/3QeaqtD>

INGRESS PROTECTION: IP41

| | | |
|---|---|--------------|
| <p>GlobTek, Inc. www.globtek.com 186 Veterans Drive, Northvale, NJ 07647 Tel. (201) 784-1000 Fax (201) 784-0111</p> | <p>Drawing Title: GTM961800P18024-T2, Medical/ICT/ITE/Household use Power Supply, Efficiency Level: USA DOE Level VI / Eco-design Directive 2009/125/EC, (EU) 2019/1782, Case Color/Style: GlobTek Black, Desktop/External, Regulated Switchmode AC-DC Power Supply AC Adaptor, Input Rating: 100-240V~, 50-60 Hz, IEC 60320/C8 , Output Rating: 180W, 24.0V@7.5A, Output Configuration: 1200 mm, 16 (Large ground 40/0.20) OD:4.3mm/1C + Shield Cond, UL 1185, 4 Pin Kycon Snap and Lock Plug KPP-4P, NO equal, Male contacts, Ferrite: None, GlobTek Black, GT Cord # C21419, Pin Out: Pin 2,4: +V, Pin 1,3, Shell: -, Blades/Input Cord: (Order Separately), Approvals: CB 60601-1-11; CB 60601-1; S-Mark IEC/EN 60601-1; cETLus; EAC; CB 60950; CB 60335; cETLus 60601-1 3rd; RCM; UKCA; Conforms to 62368-1; CCC; CB 62368; S-Mark 60950; cETLus 60950-1; cETLus 60601-1-11; cETLus 60950-1; ETL 62368; Morocco; IRAM; FCC; HKSM; PSE; CE; China RoHS; Double Insulation; PSE; PSE; Level VI; RoHS; Ukraine; VCCI; WEEE;</p> <p>Model No. GTM961800P18024-T2</p> | <p>Rev A</p> |
| <p>Part No./Ordering No. TR9KI7500YL4IMR6B</p> | | |

3D File Download <https://www.globtek.com/dl/GTM961600-GTM961800-T2.igs>

Mechanical drawing

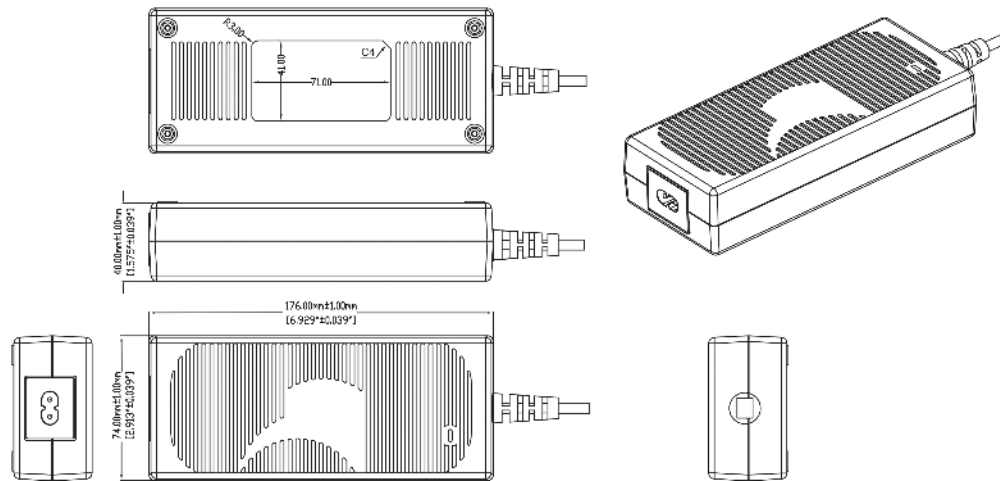

GlobTek, Inc.
 www.globtek.com
 186 Veterans Drive,
 Northvale, NJ 07647
 Tel. (201) 784-1000
 Fax (201) 784-0111

Drawing Title: GTM961800P18024-T2, Medical/ICT/ITE/Household use Power Supply, Efficiency Level: USA DOE Level VI / Eco-design Directive 2009/125/EC, (EU) 2019/1782, Case Color/Style: GlobTek Black, Desktop/External, Regulated Switchmode AC-DC Power Supply AC Adaptor, Input Rating: 100-240V~, 50-60 Hz, IEC 60320/C8, Output Rating: 180W, 24.0V@7.5A, Output Configuration: 1200 mm, 16 (Large ground 40/0.20) OD:4.3mm/1C + Shield Cond, UL 1185, 4 Pin Kycon Snap and Lock Plug KPP-4P, NO equal, Male contacts, Ferrite: None, GlobTek Black, GT Cord # C21419, Pin Out: Pin 2,4: +V, Pin 1,3, Shell: -V, Blades/Input Cord: (Order Separately), Approvals: CB 60601-1-11; CB 60601-1; S-Mark IEC/EN 60601-1; cETLus; EAC; CB 60950; CB 60335; cETLus 60601-1 3rd; RCM; UKCA; Conforms to 62368-1; CCC; CB 62368; S-Mark 60950; cETLus 60950-1; cETLus 60601-1-11; cETLus 60950-1; ETL 62368; Morocco; IRAM; FCC; HKSM; PSE; CE; China RoHS; Double Insulation; PSE; PSE; Level VI; RoHS; Ukraine; VCCI; WEEE;

Model No. GTM961800P18024-T2

Part No./Ordering No. TR9KI7500YL4IMR6B

Rev A

DERATING CURVE

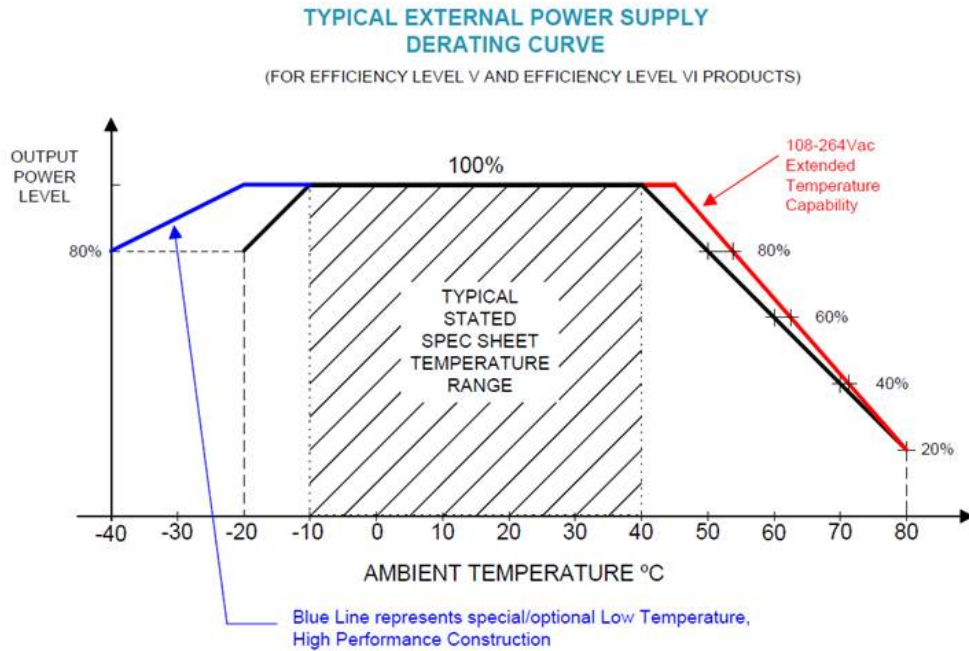

| | | |
|---|---|-------|
| GlobTek, Inc. www.globtek.com 186 Veterans Drive, Northvale, NJ 07647 Tel. (201) 784-1000 Fax (201) 784-0111 | Drawing Title: GTM961800P18024-T2, Medical/ICT/ITE/Household use Power Supply, Efficiency Level: USA DOE Level VI / Eco-design Directive 2009/125/EC, (EU) 2019/1782, Case Color/Style: GlobTek Black, Desktop/External, Regulated Switchmode AC-DC Power Supply AC Adaptor, Input Rating: 100-240V~, 50-60 Hz, IEC 60320/C8 , Output Rating: 180W, 24.0V@7.5A, Output Configuration: 1200 mm, 16 (Large ground 40/0.20) OD:4.3mm/1C + Shield Cond, UL 1185, 4 Pin Kycon Snap and Lock Plug KPP-4P, NO equal, Male contacts, Ferrite: None, GlobTek Black, GT Cord # C21419, Pin Out: Pin 2,4: +V, Pin 1,3, Shell: -V, Blades/Input Cord: (Order Separately), Approvals: CB 60601-1-11; CB 60601-1; S-Mark IEC/EN 60601-1; cETLus; EAC; CB 60950; CB 60335; cETLus 60601-1 3rd; RCM; UKCA; Conforms to 62368-1; CCC; CB 62368; S-Mark 60950; cETLus 60950-1; cETLus 60601-1-11; cETLus 60950-1; ETL 62368; Morocco; IRAM; FCC; HKSM; PSE; CE; China RoHS; Double Insulation; PSE; PSE; Level VI; RoHS; Ukraine; VCCI; WEEE; | |
| | Model No. GTM961800P18024-T2 | |
| | Part No./Ordering No. TR9KI7500YL4IMR6B | Rev A |

INPUT CONFIGURATION

(F1) Class II / Double Insulated



[Alternate grounding configurations](#) available upon request.

Blades/Cord Included:None:(Order Separately)

Blades/Cord Installed:None:(Order Separately)

IEC 60320/C8 AC Inlet connector, Class II, Non-Earth Ground (aka "Figure-8")

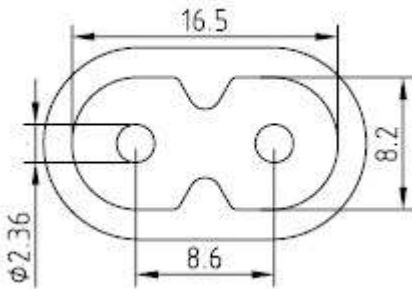

Mates with IEC 60320/C7 Plug

Below are standard cordsets which are "not included" (unless stated above); these may be purchased separately or packaged with the power supply. Please contact your Sales Engineer if the style required is not shown below. Many more available in different lengths, colors or cable material.

[Standard International IEC 320/C7 Cordsets](#)

| Part Number | Type | Standard | Connector | Length (mm) | Length (feet) |
|-------------------------------------|-------------------------------------|-----------|------------|-------------|---------------|
| 2094112M703(R) | Argentina (Type I) | IRAM 2063 | IEC 320/C7 | 2000 | 7 |
| 5014112M703A(R) | Australian (Type I) | AS 3112 | IEC 320/C7 | 2000 | 7 |
| 207B4111M8703(R) | Brazil (Type N) | NBR14136 | IEC 320/C7 | 1800 | 6 |
| 4533501M8703(R) | China (Type A) | GB 2099.1 | IEC 320/C7 | 1830 | 6 |
| 2074112M703A(R) | European (Type C) | CEE 7/16 | IEC 320/C7 | 2000 | 7 |
| 2074112M703AEUSA(R) | European/South Africa Combo(Type C) | CEE 7/16 | IEC 320/C7 | 2000 | 7 |
| 2084111M8703B(R) | India (Type D) | IS 1293 | IEC 320/C7 | 1800 | 6 |

PROPRIETARY INFORMATION

PROPRIETARY OF GLOBTEK, INC. ANY REPRODUCTION, DISCLOSURE OR USE OF THIS DRAWING, IN WHOLE OR IN PART, IS HEREBY PROHIBITED EXCEPT AS SPECIFIED IN

WRITING BY GLOBTEK, INC. © GlobTek, Inc. 2018 - 2023

quest / 08/02/2023 6:21:24 PM GMT CLONED FROM TR9CI6666MF6CIMR6B

| | | |
|---|--|--------------|
| <p>GlobTek, Inc. www.globtek.com 186 Veterans Drive, Northvale, NJ 07647 Tel. (201) 784-1000 Fax (201) 784-0111</p> | <p>Drawing Title: GTM961800P18024-T2, Medical/ICT/ITE/Household use Power Supply, Efficiency Level: USA DOE Level VI / Eco-design Directive 2009/125/EC, (EU) 2019/1782, Case Color/Style: GlobTek Black, Desktop/External, Regulated Switchmode AC-DC Power Supply AC Adaptor, Input Rating: 100-240V~, 50-60 Hz, IEC 60320/C8 , Output Rating: 180W, 24.0V@7.5A, Output Configuration: 1200 mm, 16 (Large ground 40/0.20) OD:4.3mm/1C + Shield Cond, UL 1185, 4 Pin Kycon Snap and Lock Plug KPP-4P, NO equal, Male contacts, Ferrite: None, GlobTek Black, GT Cord # C21419, Pin Out: Pin 2,4: +V, Pin 1,3, Shell: -V, Blades/Input Cord: (Order Separately), Approvals: CB 60601-1-11; CB 60601-1; S-Mark IEC/EN 60601-1; cETLus; EAC; CB 60950; CB 60335; cETLus 60601-1 3rd; RCM; UKCA; Conforms to 62368-1; CCC; CB 62368; S-Mark 60950; cETLus 60950-1; cETLus 60601-1-11; cETLus 60950-1; ETL 62368; Morocco; IRAM; FCC; HKSM; PSE; CE; China RoHS; Double Insulation; PSE; PSE; Level VI; RoHS; Ukraine; VCCI; WEEE;</p> | |
| | <p>Model No. GTM961800P18024-T2</p> | |
| | <p>Part No./Ordering No. TR9KI7500YL4IMR6B</p> | <p>Rev A</p> |

| | | | | | |
|----------------------------------|--|--------------|------------|------|---|
| 451J3401M8703(R) | Japan (Type A) | JIS 8303 | IEC 320/C7 | 1830 | 6 |
| 2044112M703A(R) | Korea (Type C) | KS C8305 | IEC 320/C7 | 2000 | 7 |
| 4511116F703A(R) | North America (Type A) | NEMA 1-15P | IEC 320/C7 | 1830 | 6 |
| 2084111M8703(R) | South Africa (Type M) | BS 546 | IEC320/C7 | 1830 | 6 |
| 4033401M8703A(R) | Taiwan (Type A) | CNS690 | IEC 320/C7 | 1830 | 6 |
| 6104112M703A(R) | UK, Hong Kong, Singapore, Gulf States (Type G) | BS1363 | IEC 320/C7 | 2000 | 7 |
| 451G1116F703A(R) | Gulf States (Kuwait, Bahrain, Oman, Qatar, Saudi Arabia, Yemen and the United Arab Emirates (UAE))(Type A) | Nema 1-15P | IEC320/C7 | 1830 | 6 |
| 6303742M5703(R) | Thailand (Type C) | TIS 166-2549 | IEC320/C7 | 2500 | 8 |

| | | |
|---|---|-------|
| GlobTek, Inc. www.globtek.com 186 Veterans Drive, Northvale, NJ 07647 Tel. (201) 784-1000 Fax (201) 784-0111 | Drawing Title: GTM961800P18024-T2, Medical/ICT/ITE/Household use Power Supply, Efficiency Level: USA DOE Level VI / Eco-design Directive 2009/125/EC, (EU) 2019/1782, Case Color/Style: GlobTek Black, Desktop/External, Regulated Switchmode AC-DC Power Supply AC Adaptor, Input Rating: 100-240V~, 50-60 Hz, IEC 60320/C8 , Output Rating: 180W, 24.0V@7.5A, Output Configuration: 1200 mm, 16 (Large ground 40/0.20) OD:4.3mm/1C + Shield Cond, UL 1185, 4 Pin Kycon Snap and Lock Plug KPP-4P, NO equal, Male contacts, Ferrite: None, GlobTek Black, GT Cord # C21419, Pin Out: Pin 2,4: +V, Pin 1,3, Shell: -V, Blades/Input Cord: (Order Separately), Approvals: CB 60601-1-11; CB 60601-1; S-Mark IEC/EN 60601-1; cETLus; EAC; CB 60950; CB 60335; cETLus 60601-1 3rd; RCM; UKCA; Conforms to 62368-1; CCC; CB 62368; S-Mark 60950; cETLus 60950-1; cETLus 60601-1-11; cETLus 60950-1; ETL 62368; Morocco; IRAM; FCC; HKSM; PSE; CE; China RoHS; Double Insulation; PSE; PSE; Level VI; RoHS; Ukraine; VCCI; WEEE; | |
| | Model No. GTM961800P18024-T2 | |
| | Part No./Ordering No. TR9KI7500YL4IMR6B | Rev A |

OUTPUT CORD AND CONNECTOR: KPP4/C21419

ACTUAL CONNECTORS, OVERMOLDS, FERRITES MAY VARY SLIGHTLY FROM THE PICTURE BELOW

| | |
|--|--|
| CABLE TYPE | UL 1185 |
| CABLE LENGTH (mm) | 1200 |
| CABLE TOLERANCE (mm) | +100, -0 |
| WIRE GAUGE (AWG) | 16 (Large ground 40/0.20) OD:4.3mm |
| CONDUCTORS | 1C + Shield |
| HANK DIMENSION (mm) | 100 ± 10 |
| CABLE / CONNECTOR OVERMOLD COLOR | GlobTek Black |
| FERRITE TYPE AND DIMENSION | None |
| FERRITE NUMBER OF TURNS (Definition) | N/A |
| FERRITE DIMENSION FROM STRAIN RELIEF | N/A |
| FERRITE DIMENSION FROM PLUG | N/A |
| PLUG TYPE | 4 Pin Kycon Snap and Lock Plug KPP-4P, NO equal, Male contacts |
| OVERMOLDED | Yes |
| OVER MOLD ORIENTATION | Straight |
| CONNECTOR PIN OUT | Pin 2,4: +V, Pin 1,3, Shell: -V |

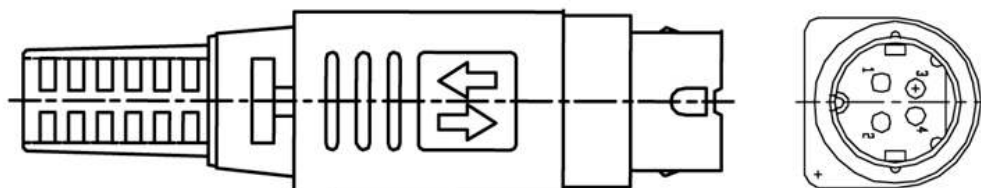

Please visit <https://en.globtek.com/news/power-din-locking-connector-cable-assemblies-and-accessories> for Power Din connector mating jacks (Shielded and unshielded), inline mating plugs, and extension cables in various custom and standard lengths available from stock in both black and white.

ADDITIONAL OUTPUT PLUG OPTIONS ARE AVAILABLE AT <https://www.globtek.com/connectors/>
STANDARD PLUGS AND CONNECTORS CAN BE SEEN ONLINE AT <https://www.globtek.com/connectors/>
CALCULATE VOLTAGE REGULATION/DROP WITH OUR ONLINE CALCULATOR: <https://en.globtek.com/output-cable-regulation-calculator/>

| | |
|---|--|
| <p>GlobTek, Inc. www.globtek.com 186 Veterans Drive, Northvale, NJ 07647 Tel. (201) 784-1000 Fax (201) 784-0111</p> | <p>Drawing Title: GTM961800P18024-T2, Medical/ICT/ITE/Household use Power Supply, Efficiency Level: USA DOE Level VI / Eco-design Directive 2009/125/EC, (EU) 2019/1782, Case Color/Style: GlobTek Black, Desktop/External, Regulated Switchmode AC-DC Power Supply AC Adaptor, Input Rating: 100-240V~, 50-60 Hz, IEC 60320/C8 , Output Rating: 180W, 24.0V@7.5A, Output Configuration: 1200 mm, 16 (Large ground 40/0.20) OD:4.3mm/1C + Shield Cond, UL 1185, 4 Pin Kycon Snap and Lock Plug KPP-4P, NO equal, Male contacts, Ferrite: None, GlobTek Black, GT Cord # C21419, Pin Out: Pin 2,4: +V, Pin 1,3, Shell: -V, Blades/Input Cord: (Order Separately), Approvals: CB 60601-1-11; CB 60601-1; S-Mark IEC/EN 60601-1; cETLus; EAC; CB 60950; CB 60335; cETLus 60601-1 3rd; RCM; UKCA; Conforms to 62368-1; CCC; CB 62368; S-Mark 60950; cETLus 60950-1; cETLus 60601-1-11; cETLus 60950-1; ETL 62368; Morocco; IRAM; FCC; HKSM; PSE; CE; China RoHS; Double Insulation; PSE; PSE; Level VI; RoHS; Ukraine; VCCI; WEEE;</p> |
| | <p>Model No. GTM961800P18024-T2</p> |
| | <p>Part No./Ordering No. TR9KI7500YL4IMR6B</p> |
| | <p>Rev A</p> |

OUTPUT CONNECTOR HOOK UP

TO ADDRESS SYSTEM-LEVEL EMI CONCERNS, FERRITE CHOKES/BEADS MAY BE ADDED/REVISED UPON REQUEST. A SAMPLE KIT OF GLOBTEK'S STANDARD FERRITES IS AVAILABLE UNDER GLOBTEK P/N: EMI-MITIGATION-KIT1

FOR ADDITIONAL INFORMATION, PLEASE READ OUR WHITE PAPER AT:

<https://en.globtek.com/technical-articles/ferrite-kit-radiated-emi-suppression-kit-for-globtek-power-supplies-cable-assemblies>

| | | |
|---|--|-------|
| GlobTek, Inc. www.globtek.com 186 Veterans Drive, Northvale, NJ 07647 Tel. (201) 784-1000 Fax (201) 784-0111 | Drawing Title: GTM961800P18024-T2, Medical/ICT/ITE/Household use Power Supply, Efficiency Level: USA DOE Level VI / Eco-design Directive 2009/125/EC, (EU) 2019/1782, Case Color/Style: GlobTek Black, Desktop/External, Regulated Switchmode AC-DC Power Supply AC Adaptor, Input Rating: 100-240V~, 50-60 Hz, IEC 60320/C8, Output Rating: 180W, 24.0V@7.5A, Output Configuration: 1200 mm, 16 (Large ground 40/0.20) OD:4.3mm/1C + Shield Cond, UL 1185, 4 Pin Kycon Snap and Lock Plug KPP-4P, NO equal, Male contacts, Ferrite: None, GlobTek Black, GT Cord # C21419, Pin Out: Pin 2,4: +V, Pin 1,3, Shell: -V, Blades/Input Cord: (Order Separately), Approvals: CB 60601-1-11; CB 60601-1; S-Mark IEC/EN 60601-1; cETLus; EAC; CB 60950; CB 60335; cETLus 60601-1 3rd; RCM; UKCA; Conforms to 62368-1; CCC; CB 62368; S-Mark 60950; cETLus 60950-1; cETLus 60601-1-11; cETLus 60950-1; ETL 62368; Morocco; IRAM; FCC; HKSM; PSE; CE; China RoHS; Double Insulation; PSE; PSE; Level VI; RoHS; Ukraine; VCCI; WEEE; | |
| | Model No. GTM961800P18024-T2 | |
| | Part No./Ordering No. TR9KI7500YL4IMR6B | Rev A |

LABEL:L-1186

| | |
|--------------------------------|--|
| LABEL P/N | Standard GT |
| MATERIAL | Flat Thermal Transfer, Imprintable, Polyester Label and/or Pad Printed and/or Molded, and/or Laser Engraved in the case |
| BACKGROUND COLOR | Black if housing is Black, White or Silver if housing is White or Gray. |
| TEXT COLOR | White or Silver if label is Black Background for Black housing. Black if label is White or Silver background and Housing is White or Gray. |
| LABEL WIDTH (mm) | 41 |
| LABEL HEIGHT (mm) | 71 |
| SPECIAL BARCODE LABEL MATERIAL | No |

Below is the minimum information which will appear on the label. NOTE: in the logo area additional/actual positioning of symbols and text is subjected to change as per agency updates/requirements or additional model approvals become available. Regulatory certifications/label markings may be in logo area on the label or molded into the case housing outside the label area. Information will be shown via label and/or pad printed and/or molded and/or laser engraved in the case. * Date code markings at GlobTek option

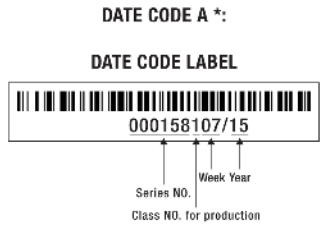

or
DATE CODE B *:
 WWYY
 WW = WEEK
 YY = YEAR

- A=Medical/ICT/ITE/Household use Power Supply
- B=P/N: (料号) TR9KI7500YL4IMR6B
- C=Model (型号) GTM961800P18024-T2
- D=Input (输入)100-240V~, 50-60 Hz, 2.2A
- E=Output (输出)24.0 V 7.5 A, 180.00W

| | | |
|---|---|-------|
| GlobTek, Inc. www.globtek.com 186 Veterans Drive, Northvale, NJ 07647 Tel. (201) 784-1000 Fax (201) 784-0111 | Drawing Title: GTM961800P18024-T2, Medical/ICT/ITE/Household use Power Supply, Efficiency Level: USA DOE Level VI / Eco-design Directive 2009/125/EC, (EU) 2019/1782, Case Color/Style: GlobTek Black, Desktop/External, Regulated Switchmode AC-DC Power Supply AC Adaptor, Input Rating: 100-240V~, 50-60 Hz, IEC 60320/C8 , Output Rating: 180W, 24.0V@7.5A, Output Configuration: 1200 mm, 16 (Large ground 40/0.20) OD:4.3mm/1C + Shield Cond, UL 1185, 4 Pin Kycon Snap and Lock Plug KPP-4P, NO equal, Male contacts, Ferrite: None, GlobTek Black, GT Cord # C21419, Pin Out: Pin 2,4: +V, Pin 1,3, Shell: -V, Blades/Input Cord: (Order Separately), Approvals: CB 60601-1-11; CB 60601-1; S-Mark IEC/EN 60601-1; cETLus; EAC; CB 60950; CB 60335; cETLus 60601-1 3rd; RCM; UKCA; Conforms to 62368-1; CCC; CB 62368; S-Mark 60950; cETLus 60950-1; cETLus 60601-1-11; cETLus 60950-1; ETL 62368; Morocco; IRAM; FCC; HKSM; PSE; CE; China RoHS; Double Insulation; PSE; PSE; Level VI; RoHS; Ukraine; VCCI; WEEE; | |
| | Model No. GTM961800P18024-T2 | |
| | Part No./Ordering No. TR9KI7500YL4IMR6B | Rev A |

| | |
|---|---|
| AGENCY ONLINE DOCUMENTS | http://www.globtek.info/certs/GTM961800P/ |
| CE EC-Declaration for Medical | http://globtek.force.com/models/ec_declaration_product?id=01t0c000008OxW6&m=1 |
| CE EC-Declaration for Industrial/Commercial/ITE | http://globtek.force.com/models/ec_declaration_product?id=01t0c000008OxW6&i=2 |
| CE EC-Declaration for Household | http://globtek.force.com/models/ec_declaration_product?id=01t0c000008OxW6&h=2 |
| UKCA-Declaration for Medical | http://globtek.force.com/models/ukca_declaration_product?id=01t0c000008OxW6&m=1 |
| UKCA-Declaration for Industrial/Commercial/ITE | http://globtek.force.com/models/ukca_declaration_product?id=01t0c000008OxW6&i=2 |
| UKCA-Declaration for Household | http://globtek.force.com/models/ukca_declaration_product?id=01t0c000008OxW6&h=2 |
| Morocco SDoC Declaration | https://globtek.secure.force.com/models/Morocco_SDoC_Declaration?id=a0Oa000000FkVmvEAF |
| RoHS/RoHS3 Declaration | https://www.globtek.com/pdf/rohs_cert/01t0c000008OxW6AAK |
| REACH Declaration | https://www.globtek.com/pdf/iso_certificates/REACH.pdf |
| Conflict Minerals Declaration | https://www.globtek.com/pdf/conflict-minerals.pdf |
| Prop 65 Statement | https://en.globtek.com/prop-65-statement.pdf |

IPXY rating is based on 3rd party testing and customers should check suitability and test system level IPXY rating before ordering.

Regulatory Certifications/Label Markings

Below follows a link to the latest regulatory certifications and marks for this specific product. National standards as well as certification schemes are constantly changing and so is the set of certification marks and symbols applicable to this product. Various standards, marks and symbols, and certificates are subject to change at any time without notice.

Additional standards or unique country certifications are available upon request. Please contact Globtek to request a quotation.

| | |
|--------------------------------------|---|
| LATEST PRODUCT/MODEL CERTIFICATIONS: | https://www.globtek.com/datasheet/w70835 |
| AGENCY ONLINE DOCUMENTS | http://www.globtek.info/certs/GTM961800P/ |

| | |
|--|----------------------------------|
|  | (F1) Class II / Double Insulated |
|--|----------------------------------|

Front View



Pin 2,4: +V, Pin 1,3, Shell: -V

| | | |
|---|---|-------|
| GlobTek, Inc. www.globtek.com 186 Veterans Drive, Northvale, NJ 07647 Tel. (201) 784-1000 Fax (201) 784-0111 | Drawing Title: GTM961800P18024-T2, Medical/ICT/ITE/Household use Power Supply, Efficiency Level: USA DOE Level VI / Eco-design Directive 2009/125/EC, (EU) 2019/1782, Case Color/Style: GlobTek Black, Desktop/External, Regulated Switchmode AC-DC Power Supply AC Adaptor, Input Rating: 100-240V~, 50-60 Hz, IEC 60320/C8 , Output Rating: 180W, 24.0V@7.5A, Output Configuration: 1200 mm, 16 (Large ground 40/0.20) OD:4.3mm/1C + Shield Cond, UL 1185, 4 Pin Kycon Snap and Lock Plug KPP-4P, NO equal, Male contacts, Ferrite: None, GlobTek Black, GT Cord # C21419, Pin Out: Pin 2,4: +V, Pin 1,3, Shell: -V, Blades/Input Cord: (Order Separately), Approvals: CB 60601-1-11; CB 60601-1; S-Mark IEC/EN 60601-1; cETLus; EAC; CB 60950; CB 60335; cETLus 60601-1 3rd; RCM; UKCA; Conforms to 62368-1; CCC; CB 62368; S-Mark 60950; cETLus 60950-1; cETLus 60601-1-11; cETLus 60950-1; ETL 62368; Morocco; IRAM; FCC; HKSM; PSE; CE; China RoHS; Double Insulation; PSE; PSE; Level VI; RoHS; Ukraine; VCCI; WEEE; | |
| | Model No. GTM961800P18024-T2 | |
| | Part No./Ordering No. TR9KI7500YL4IMR6B | Rev A |

PACKAGING

| | |
|--|---|
| Packing Spec P/N | Standard DT, Cellular packaging, User manual |
| Box Qty | 20 |
| Gift Box Size (mm) | Cellular Packaging |
| Gift Box Color | None |
| Master Carton Size (mm) | 450 x 461 x 182 |
| Master Carton Cubic Volume (m ³) | 0.04 |
| Master GW (Kg) | 16.0 kg |
| BLADES INCLUDED | None: (Order Separately) |
| BLADE/CORD INSTALLED | None: (Order Separately) |
| USER MANUAL* | 809-DESKTOPUSERMANUAL on A4 paper |
| USER MANUAL WEB LINK | https://en.globtek.com/pdf/809-DESKTOPUSERMANUAL.jpg |

* This specification sheet is considered the user manual for all applications. It is expected that the buyer of this product will use it to formulate their own user manual for their end product and a user manual specifically for the power adapter is not usually required. If a user manual is not specifically listed above then none will be provided with this unit.

If specific packaging is required, this section must specify all requirements and note "no exceptions". If this section does not specify packaging, it is subject to change without notice at GlobTek's discretion.

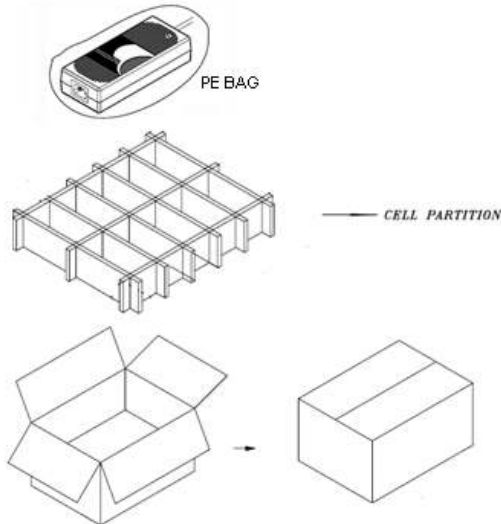

PROPRIETARY INFORMATION

| | | |
|---|---|-------|
| GlobTek, Inc. www.globtek.com 186 Veterans Drive, Northvale, NJ 07647 Tel. (201) 784-1000 Fax (201) 784-0111 | Drawing Title: GTM961800P18024-T2, Medical/ICT/ITE/Household use Power Supply, Efficiency Level: USA DOE Level VI / Eco-design Directive 2009/125/EC, (EU) 2019/1782, Case Color/Style: GlobTek Black, Desktop/External, Regulated Switchmode AC-DC Power Supply AC Adaptor, Input Rating: 100-240V~, 50-60 Hz, IEC 60320/C8 , Output Rating: 180W, 24.0V@7.5A, Output Configuration: 1200 mm, 16 (Large ground 40/0.20) OD:4.3mm/1C + Shield Cond, UL 1185, 4 Pin Kycon Snap and Lock Plug KPP-4P, NO equal, Male contacts, Ferrite: None, GlobTek Black, GT Cord # C21419, Pin Out: Pin 2,4: +V, Pin 1,3, Shell: -V, Blades/Input Cord: (Order Separately), Approvals: CB 60601-1-11; CB 60601-1; S-Mark IEC/EN 60601-1; cETLus; EAC; CB 60950; CB 60335; cETLus 60601-1 3rd; RCM; UKCA; Conforms to 62368-1; CCC; CB 62368; S-Mark 60950; cETLus 60950-1; cETLus 60601-1-11; cETLus 60950-1; ETL 62368; Morocco; IRAM; FCC; HKSM; PSE; CE; China RoHS; Double Insulation; PSE; PSE; Level VI; RoHS; Ukraine; VCCI; WEEE; | |
| | Model No. GTM961800P18024-T2 | |
| | Part No./Ordering No. TR9KI7500YL4IMR6B | Rev A |

INSTRUCTIONS TO THE OEM SYSTEMS ENGINEER

It is the responsibility of the OEM systems engineer to provide the end system user instructions and warnings for the use of this product in the end system.

If an input cord is required for this product, AC Mains voltage should be provided to the power supply by a power supply cord approved to the national standards of the country in which it will be used.

This product is not designed to be repaired. No serviceable parts inside. A blown internal fuse is an indication of catastrophic failure of circuit component(s). If a Failure Analysis is required for a failed power supply/battery charger, please return the damaged unit to GlobTek for an accurate determination of the root cause of the failure.

EMC Compliance of the complete OEM product, including the GlobTek power supply/battery charger needs to be verified by the OEM systems engineer.

INSTRUCTION SHEET

N/A

PROPRIETARY INFORMATION

| | |
|--|--|
| <p>GlobTek, Inc. www.globtek.com 186 Veterans Drive, Northvale, NJ 07647 Tel. (201) 784-1000 Fax (201) 784-0111</p> | <p>Drawing Title: GTM961800P18024-T2, Medical/ICT/ITE/Household use Power Supply, Efficiency Level: USA DOE Level VI / Eco-design Directive 2009/125/EC, (EU) 2019/1782, Case Color/Style: GlobTek Black, Desktop/External, Regulated Switchmode AC-DC Power Supply AC Adaptor, Input Rating: 100-240V~, 50-60 Hz, IEC 60320/C8 , Output Rating: 180W, 24.0V@7.5A, Output Configuration: 1200 mm, 16 (Large ground 40/0.20) OD:4.3mm/1C + Shield Cond, UL 1185, 4 Pin Kycon Snap and Lock Plug KPP-4P, NO equal, Male contacts, Ferrite: None, GlobTek Black, GT Cord # C21419, Pin Out: Pin 2,4: +V, Pin 1,3, Shell: -V, Blades/Input Cord: (Order Separately), Approvals: CB 60601-1-11; CB 60601-1; S-Mark IEC/EN 60601-1; cETLus; EAC; CB 60950; CB 60335; cETLus 60601-1 3rd; RCM; UKCA; Conforms to 62368-1; CCC; CB 62368; S-Mark 60950; cETLus 60950-1; cETLus 60601-1-11; cETLus 60950-1; ETL 62368; Morocco; IRAM; FCC; HKSM; PSE; CE; China RoHS; Double Insulation; PSE; PSE; Level VI; RoHS; Ukraine; VCCI; WEEE;</p> |
| | <p>Model No. GTM961800P18024-T2</p> |
| | <p>Part No./Ordering No. TR9KI7500YL4IMR6B</p> |
| | <p>Rev A</p> |

