

DO NOT SCALE ALL DIMENSIONS ARE FOR REFERENCE ONLY

OPERATING CRITERIA

VOLTS: 240 AMPS: 10 HZ:

OPERATING TEMPS. DEG. C

OPEN: 50 ± 3
 CLOSE: 35 ± 5

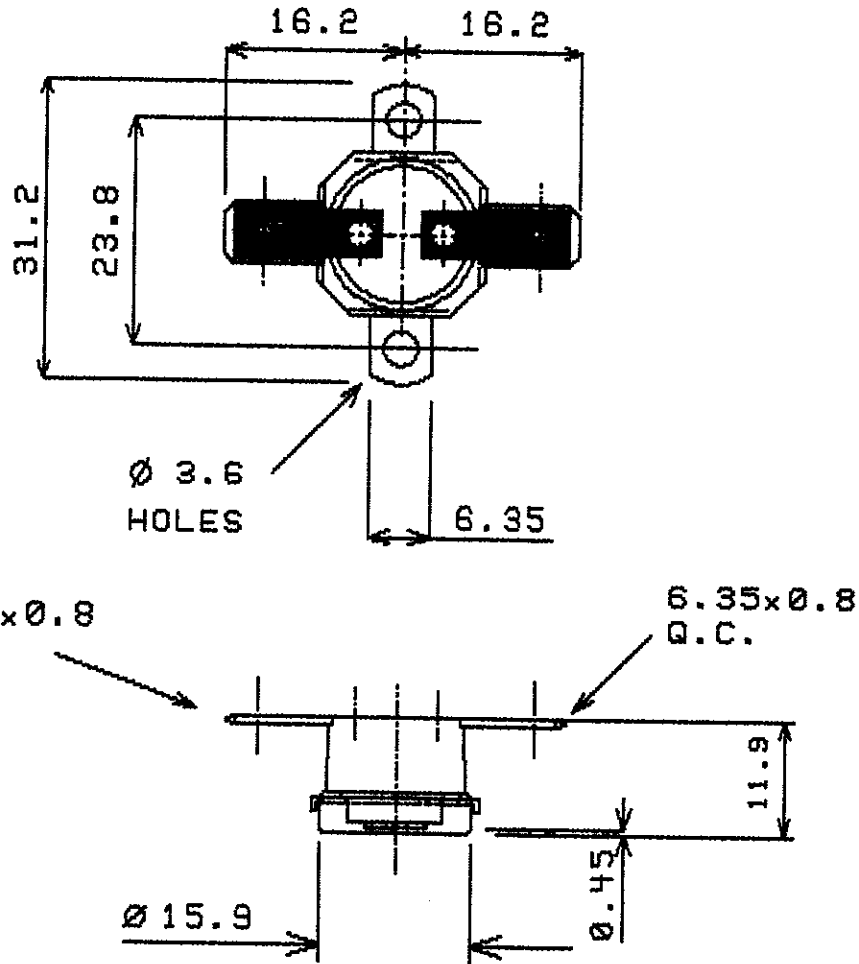

NOTE: ORIENTATION OF BRACKET IS NOT FIXED

ISSUE	A	B							
MOD No	2052	2250							
MTH/YR	3/97	7/98							

CODING REQUIREMENTS

COLOUR: LASER CODE
 L50C RP 9100 433 XXX

(XXX = DATE CODING)

CAP: B200 MAT'L: ALUMINIUM
 BRK'T: B2036 MAT'L: STEEL
 PLATING: NICKEL
 TERMINAL: T148 T148
 MATERIAL: BRASS BRASS
 PLATING:

ELMWOOD DEVICE & UNIQUE PART No.
 2455RP-9100-433

ELMWOOD DRG No.
 965201

ISSUE
 B



ELMWOOD
 SENSORS LTD

DATE OF ISSUE STAMP

7 JUL 1998