

General information

| | |
|-------------------|---------------------|
| Part number | K20KAC-P07LCC0-200S |
| Termination | solder |
| Size | 0 |
| Locking principle | break , push |
| Coding | a_key |
| Cable Diameter | cable_mini_20 |
| Cable outlet | bend_relief |

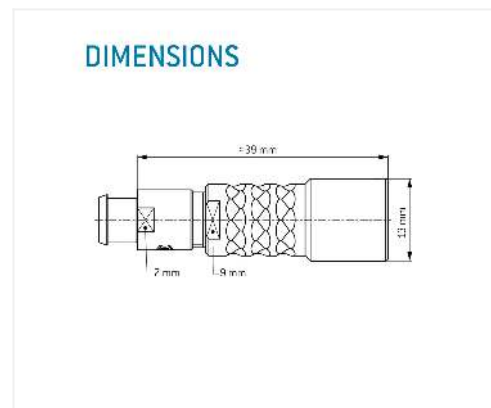
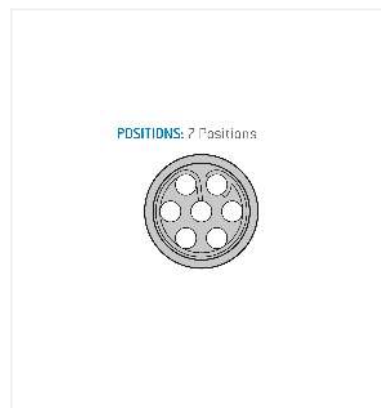

Contact insert description

| | |
|----------------------|---------|
| Number of contacts | 7 |
| Contact type | sockets |
| Contact diameter | 05mm |
| Insulator material | peek |
| Wire cross section | 28_awg |
| Termination | solder |
| Termination diameter | 04mm |

reverse_gender_on_request

Technical information

| | | |
|--|----------|---------------|
| Max. creepage and air clearance distance | 07_mm | 07_mm |
| Nominal current single contact | 04_a | iec_60512_5_2 |
| Nominal current insert | 2,6 A | vde_0298_4 |
| Test voltage | 09_kv_ac | sae_13441 |

safety_text

Mechanical and environmental data

| | |
|-----------------------|------|
| Degree of protection* | ip68 |
|-----------------------|------|

| | |
|-----------------------|----------|
| Operating temperature | 40_120_c |
|-----------------------|----------|

| | |
|---------------|------|
| Mating cycles | 5000 |
|---------------|------|

mated

Material and surface treatments

| | |
|---------|----------|
| Housing | m_chrome |
|---------|----------|

| | |
|---------|---------------|
| Contact | cu_alloy_gold |
|---------|---------------|

safety_text_2

ul_text

illustrative_text