



Power Key 5.0

TE Internal #: 2-1376392-3

Rectangular Power Connectors, Housing, Plug, Wire-to-Board, 4 Position, 5 mm [.197 in] Centerline, Printed Circuit Board, UL 94V-0, Power Key 5.0

[View on TE.com >](#)

Connectors > Power Connectors > Rectangular Power > Rectangular Power Connectors > STD Temp Power Key Plug

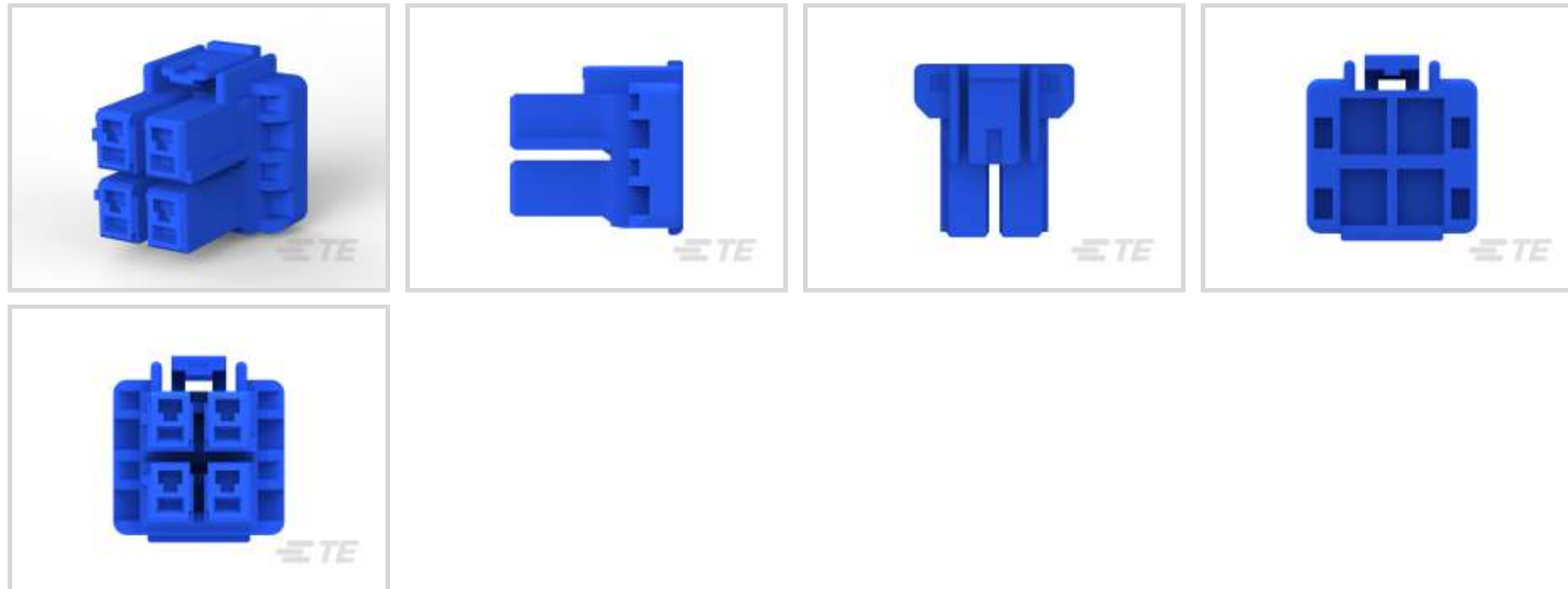

Rectangular Power Connector Type: **Housing**

Connector & Housing Type: **Plug**

Connector System: **Wire-to-Board**

Number of Positions: **4**

Centerline (Pitch): **5 mm [.197 in]**

[All STD Temp Power Key Plug \(34\)](#)

Features

Product Type Features

Rectangular Power Connector Type	Housing
Connector & Housing Type	Plug
Connector System	Wire-to-Board
Sealable	No
Connector & Contact Terminates To	Printed Circuit Board

Configuration Features

Number of Positions	4
Number of Power Positions	4
Number of Signal Positions	0
Number of Rows	2

Electrical Characteristics

Operating Voltage	300 VAC
-------------------	---------



Contact Features

Contact Retention Within Housing	Without
Contact Type	Receptacle

Termination Features

Termination Method to Wire & Cable	Crimp
------------------------------------	-------

Mechanical Attachment

Connector Mounting Type	Cable Mount (Free-Hanging)
-------------------------	----------------------------

Housing Features

Centerline (Pitch)	5 mm [.197 in]
Housing Color	Natural
Housing Material	Nylon 6/6 GF

Dimensions

Row-to-Row Spacing	6.2 mm [.244 in]
--------------------	------------------

Usage Conditions

Operating Temperature Range	-30 – 105 °C [-22 – 221 °F]
-----------------------------	-----------------------------

Operation/Application

Circuit Application	Power
---------------------	-------

Industry Standards

UL Flammability Rating	UL 94V-0
Glow Wire Rating	Standard Part - Not Glow Wire

Packaging Features

Packaging Quantity	500
Packaging Method	Bag

Product Compliance

[For compliance documentation, visit the product page on TE.com>](#)

EU RoHS Directive 2011/65/EU	Compliant
EU ELV Directive 2000/53/EC	Compliant
China RoHS 2 Directive MIIT Order No 32, 2016	No Restricted Materials Above Threshold
EU REACH Regulation (EC) No. 1907/2006	Current ECHA Candidate List: JUNE 2023 (235) Candidate List Declared Against: JUNE 2023 (235)



Does not contain REACH SVHC

Halogen Content

Not Low Halogen - contains Br or Cl > 900 ppm.

Solder Process Capability

Not applicable for solder process capability

Product Compliance Disclaimer

This information is provided based on reasonable inquiry of our suppliers and represents our current actual knowledge based on the information they provided. This information is subject to change. The part numbers that TE has identified as EU RoHS compliant have a maximum concentration of 0.1% by weight in homogenous materials for lead, hexavalent chromium, mercury, PBB, PBDE, DBP, BBP, DEHP, DIBP, and 0.01% for cadmium, or qualify for an exemption to these limits as defined in the Annexes of Directive 2011/65/EU (RoHS2). Finished electrical and electronic equipment products will be CE marked as required by Directive 2011/65/EU. Components may not be CE marked. Additionally, the part numbers that TE has identified as EU ELV compliant have a maximum concentration of 0.1% by weight in homogenous materials for lead, hexavalent chromium, and mercury, and 0.01% for cadmium, or qualify for an exemption to these limits as defined in the Annexes of Directive 2000/53/EC (ELV). Regarding the REACH Regulation, the information TE provides on SVHC in articles for this part number is based on the latest European Chemicals Agency (ECHA) 'Guidance on requirements for substances in articles' posted at this URL: <https://echa.europa.eu/guidance-documents/guidance-on-reach>

Compatible Parts



TE Part # CAT-P8704-P729
STD Temp Power Key Plug



TE Part # CAT-P8704-P729A
Glow Wire Power Key Plug



TE Part # 2-1376386-3
5mm B-T-W Conn. 4P(2row) HDR A

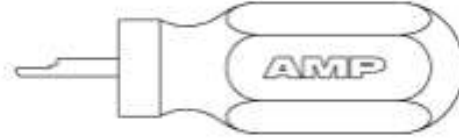

TE Part # 1463644-1
EXT-TOOL,5.0 POWER KEY CONN.



TE Part # 2-1376386-6
5.0 PK CONN. 4P(2ROW) HDR ASSY



TE Part # 2371335-3
5.0 PK SMT, 4P HDR ASSY, Blue

Also in the Series | Power Key 5.0



Insertion & Extraction Tools(1)



PCB Latches, Locks & Retainers(4)



Power Contacts(4)



Rectangular Power Connectors(107)

Customers Also Bought

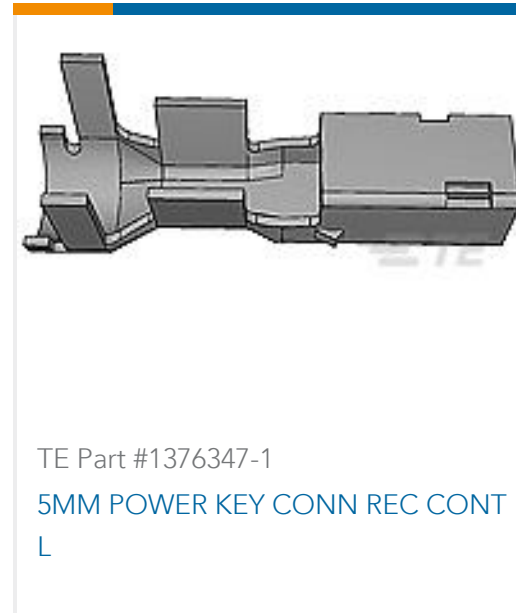
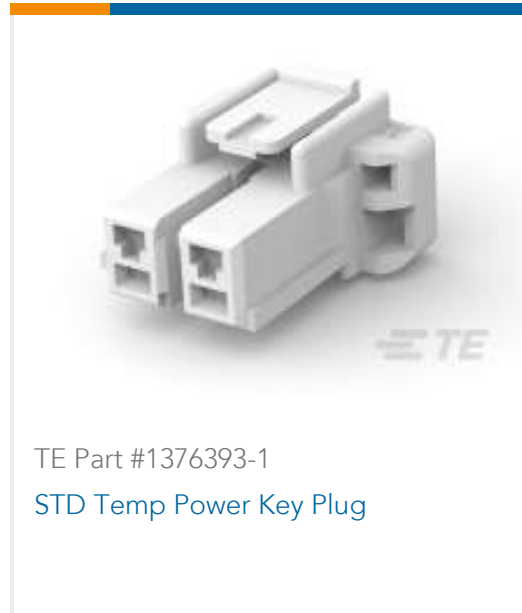

Documents

Product Drawings

[5MM POWER KEY 4P PLUG 2ROW BLU](#)

English

CAD Files

[3D PDF](#)

3D

Customer View Model

[ENG_CVM_CVM_2-1376392-3_H_c-2-1376392-3-h.2d_dxf.zip](#)

English

Customer View Model

[ENG_CVM_CVM_2-1376392-3_H_c-2-1376392-3-h.3d_igs.zip](#)

English

Customer View Model

[ENG_CVM_CVM_2-1376392-3_H_c-2-1376392-3-h.3d_stp.zip](#)

English

By downloading the CAD file I accept and agree to the [Terms and Conditions](#) of use.

Datasheets & Catalog Pages

[SOFT_SHELL_PIN_SOCKET_CONNECTORS_STANDARD_DENSITY](#)

English

[1-1773881-9 Power Key Connector Quick Reference Guide](#)

English

Product Specifications

[5.0 POWER KEY CONNECTOR](#)



Japanese

[Application Specification](#)

Japanese

[Product Environmental Compliance](#)

[TE Material Declaration](#)

English

[Instruction Sheets](#)

[The extraction tool for 5MM Power Key Contact](#)

English

[Instruction Sheet \(non U.S.\)](#)

English

[Agency Approvals](#)

[VDE Certificate](#)

English