

3M™ Pak 5 Socket

0.5 mm Straight Stacking, Surface Mount

PK5 Series

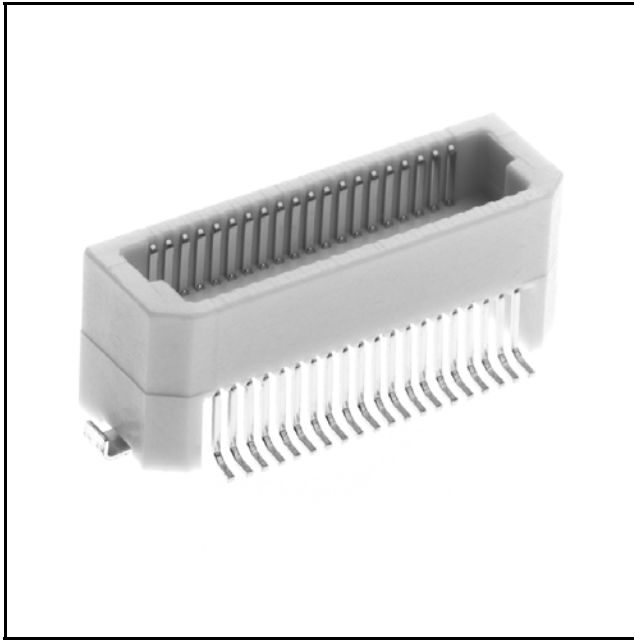

- 0.5 mm pitch high density connector conserves board space
- Mated heights available from 4 to 8 mm
- Surface mount design allows for easy inspection and repair of solder joints
- Tape and reel packaging available
- RoHS* compliant

Date Modified: July 10, 2006

TS-1149-02
Sheet 1 of 5

Physical

Insulation

Material: Glass filled LCP
Flammability: UL 94V-0
Color: White

Contact

Material: Copper Alloy

Plating

Underplating: Nickel
Wiping Area: $2 \mu\text{m}$ [$0.05 \mu\text{m}$] min. Gold over Nickel
Solder Tails: Gold over Nickel

Electrical

Current Rating: 0.3 A

Insulation Resistance: $10^3 \text{ M}\Omega$ min at 250 VDC

Withstanding Voltage: 200 VAC for 1 minute

Environmental

Temperature Rating: -55°C to $+85^\circ\text{C}$

Process Rating: 260°C (per J-STD-020C)

* RoHS = Directive 2002/95/EC, Restriction of the Use of Certain Hazardous Substances in Electrical and Electronic Equipment
"RoHS compliant" means that the product or part does not contain any of the following substances in excess of the following maximum concentration values in any homogeneous material, unless the substance is in an application that is exempt under RoHS: (a) 0.1% (by weight) for lead, mercury, hexavalent chromium, polybrominated biphenyls or polybrominated diphenyl ethers; or (b) 0.01% (by weight) for cadmium. Unless otherwise stated by 3M in writing, this information represents 3M's knowledge and belief based upon information provided by third party suppliers to 3M.

3M™ Pak 5 Socket

0.5 mm Straight Stacking, Surface Mount

PK5 Series

Socket for 4 and 6 mm stacked height.

Product Table / Dimensions

Contact Quantity	A	B	C	D	E	F	G	H
40	9.50	10.82	11.62	13.22	10.50	11.76	14.54	13.59
	[0.374]	[0.426]	[0.457]	[0.520]	[0.413]	[0.463]	[0.572]	[0.535]
50	12.00	13.32	14.12	15.72	13.00	14.26	17.04	16.09
	[0.472]	[0.524]	[0.556]	[0.619]	[0.512]	[0.561]	[0.671]	[0.633]
60	14.50	15.82	16.62	18.22	15.50	16.76	19.54	18.59
	[0.571]	[0.623]	[0.654]	[0.717]	[0.610]	[0.660]	[0.769]	[0.732]
80	19.50	20.82	21.62	23.22	20.50	21.76	24.54	23.59
	[0.768]	[0.820]	[0.851]	[0.914]	[0.807]	[0.857]	[0.966]	[0.929]
100	24.50	25.82	26.62	28.22	25.50	26.76	29.54	28.59
	[0.965]	[1.017]	[1.048]	[1.111]	[1.004]	[1.054]	[1.163]	[1.126]
120	29.50	30.82	31.62	33.22	30.50	31.76	34.54	33.59
	[1.161]	[1.213]	[1.245]	[1.308]	[1.201]	[1.250]	[1.360]	[1.322]
140	34.50	35.82	36.62	38.22	35.50	36.76	39.54	38.59
	[1.358]	[1.410]	[1.442]	[1.505]	[1.398]	[1.447]	[1.557]	[1.519]
160	39.50	40.82	41.62	43.22	40.50	41.76	44.54	43.59
	[1.555]	[1.607]	[1.639]	[1.702]	[1.594]	[1.644]	[1.754]	[1.716]

Printed Circuit Board Layout (Component Side View)

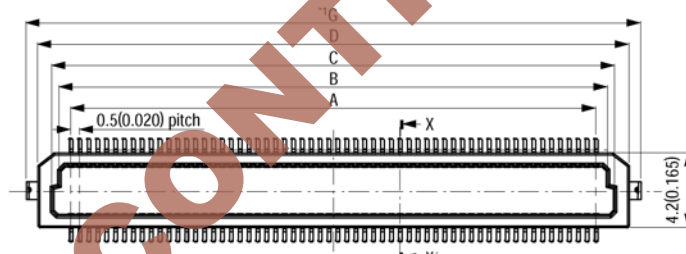
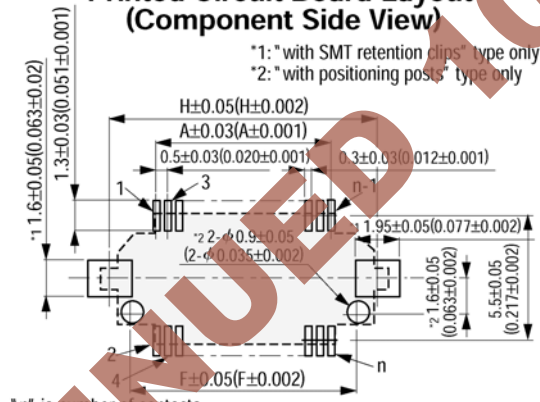

X-X' Cross Section

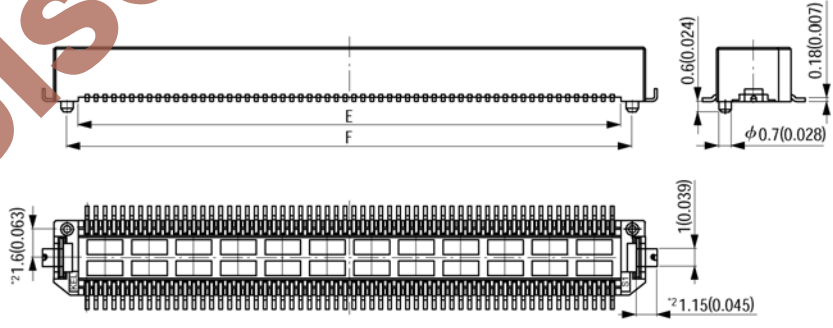
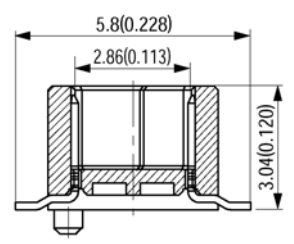

TS-1149-02
 Sheet 2 of 5

3M™ Pak 5 Socket

0.5 mm Straight Stacking, Surface Mount

PK5 Series

Socket for 5 and 7 mm stacked height.

Product Table / Dimensions

Contact Quantity	A	B	C	D	E	F	G	H
40	9.50	10.82	11.62	13.22	10.50	11.76	14.54	13.59
	[0.374]	[0.426]	[0.457]	[0.520]	[0.413]	[0.463]	[0.572]	[0.535]
50	12.00	13.32	14.12	15.72	13.00	14.26	17.04	16.09
	[0.472]	[0.524]	[0.556]	[0.619]	[0.512]	[0.561]	[0.671]	[0.633]
60	14.50	15.82	16.62	18.22	15.50	16.76	19.54	18.59
	[0.571]	[0.623]	[0.654]	[0.717]	[0.610]	[0.660]	[0.769]	[0.732]
80	19.50	20.82	21.62	23.22	20.50	21.76	24.54	23.59
	[0.768]	[0.820]	[0.851]	[0.914]	[0.807]	[0.857]	[0.966]	[0.929]
100	24.50	25.82	26.62	28.22	25.50	26.76	29.54	28.59
	[0.965]	[1.017]	[1.048]	[1.111]	[1.004]	[1.054]	[1.163]	[1.126]
120	29.50	30.82	31.62	33.22	30.50	31.76	34.54	33.59
	[1.161]	[1.213]	[1.245]	[1.308]	[1.201]	[1.250]	[1.360]	[1.322]
140	34.50	35.82	36.62	38.22	35.50	36.76	39.54	38.59
	[1.358]	[1.410]	[1.442]	[1.505]	[1.398]	[1.447]	[1.557]	[1.519]
160	39.50	40.82	41.62	43.22	40.50	41.76	44.54	43.59
	[1.555]	[1.607]	[1.639]	[1.702]	[1.594]	[1.644]	[1.754]	[1.716]

X-X' Cross Section

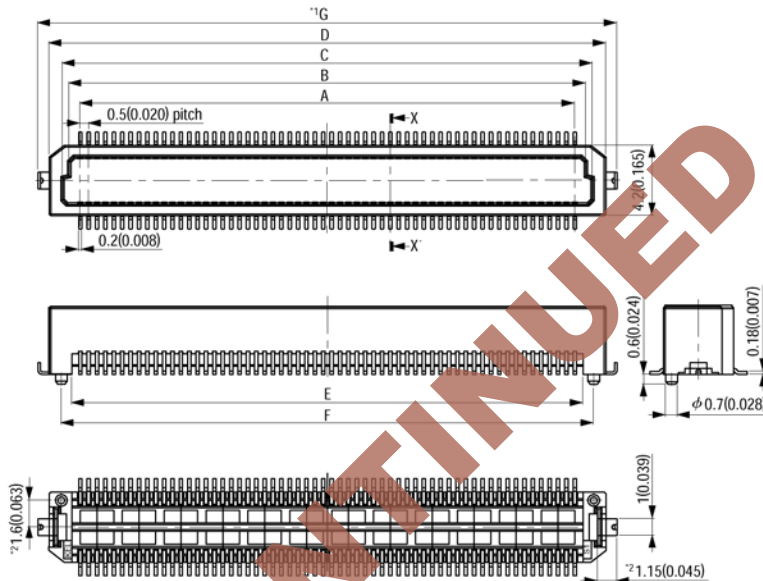
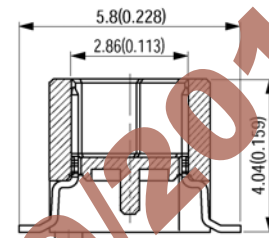

Printed Circuit Board Layout (Component Side View)

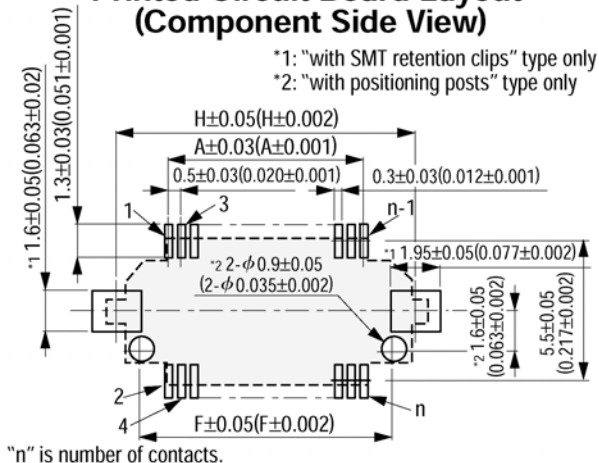

TS-1149-02
Sheet 3 of 5

3M™ Pak 5 Socket

0.5 mm Straight Stacking, Surface Mount

PK5 Series

Socket for 6 and 8 mm stacked height.

Product Table / Dimensions

Contact Quantity	A	B	C	D	E	F	G	H
40	9.50 [0.374]	10.82 [0.426]	11.62 [0.457]	13.22 [0.520]	10.50 [0.413]	11.76 [0.463]	14.54 [0.572]	13.59 [0.535]
50	12.00 [0.472]	13.32 [0.524]	14.12 [0.556]	15.72 [0.619]	13.00 [0.512]	14.26 [0.561]	17.04 [0.671]	16.09 [0.633]
60	14.50 [0.571]	15.82 [0.623]	16.62 [0.654]	18.22 [0.717]	15.50 [0.610]	16.76 [0.660]	19.54 [0.769]	18.59 [0.732]
80	19.50 [0.768]	20.82 [0.820]	21.62 [0.851]	23.22 [0.914]	20.50 [0.807]	21.76 [0.857]	24.54 [0.966]	23.59 [0.929]
100	24.50 [0.965]	25.82 [1.017]	26.62 [1.048]	28.22 [1.111]	25.50 [1.004]	26.76 [1.054]	29.54 [1.163]	28.59 [1.126]
120	29.50 [1.161]	30.82 [1.213]	31.62 [1.245]	33.22 [1.308]	30.50 [1.201]	31.76 [1.250]	34.54 [1.360]	33.59 [1.322]
140	34.50 [1.358]	35.82 [1.410]	36.62 [1.442]	38.22 [1.505]	35.50 [1.398]	36.76 [1.447]	39.54 [1.557]	38.59 [1.519]
160	39.50 [1.555]	40.82 [1.607]	41.62 [1.639]	43.22 [1.702]	40.50 [1.594]	41.76 [1.644]	44.54 [1.754]	43.59 [1.716]

X-X' Cross Section

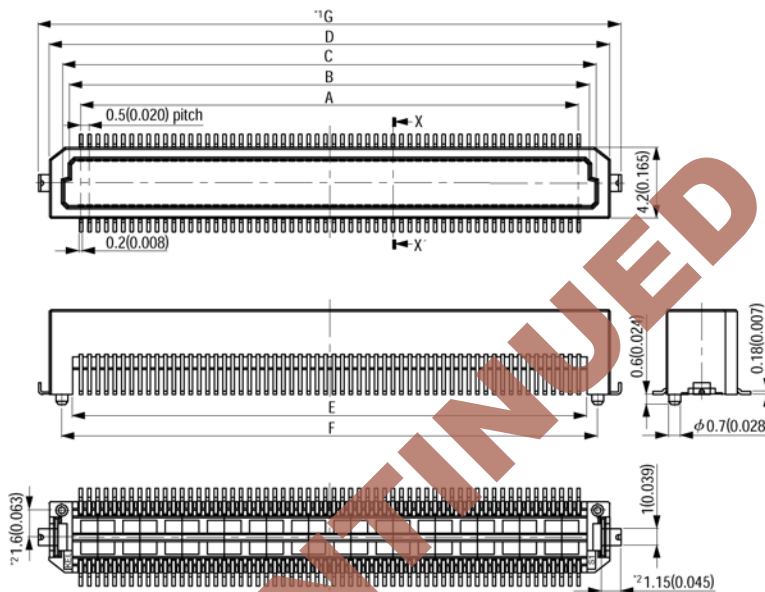
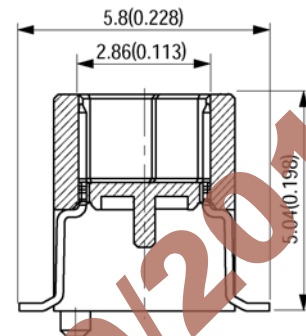

Printed Circuit Board Layout (Component Side View)

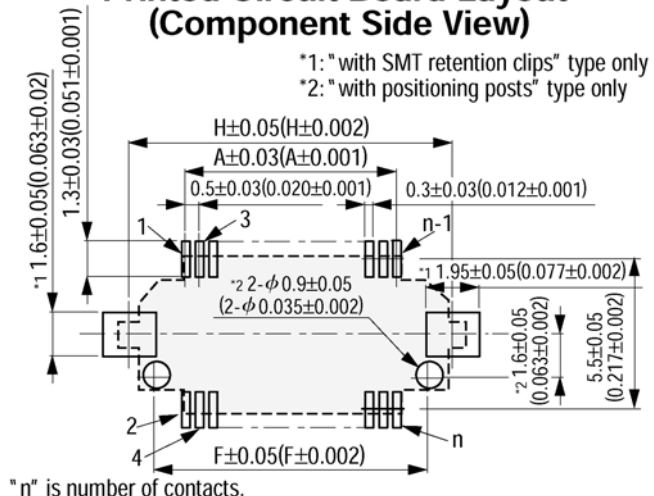

TS-1149-02
Sheet 4 of 5

3M™ Pak 5 Socket

0.5 mm Straight Stacking, Surface Mount

PK5 Series

STACKED MATING COMBINATIONS

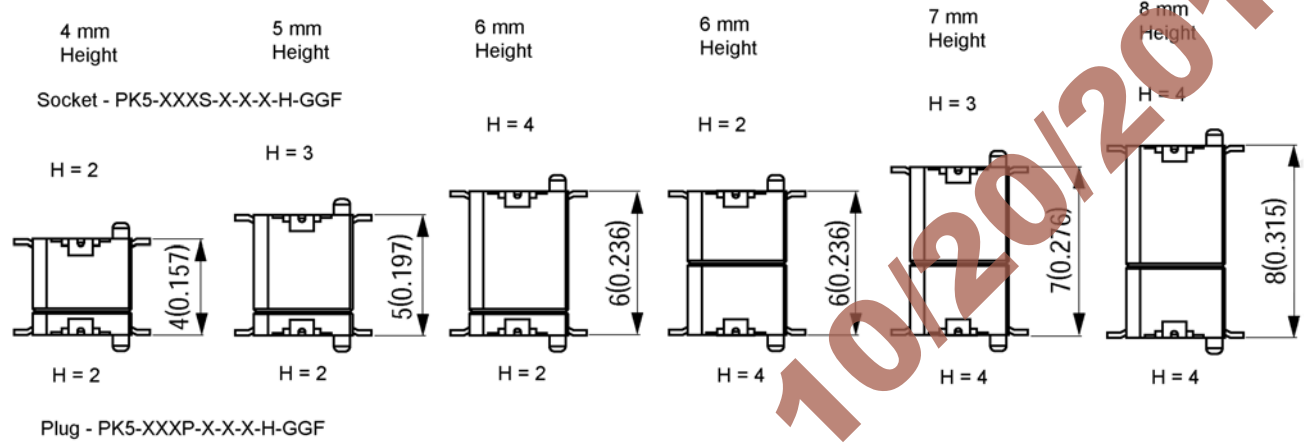

Ordering Information

PK5 - XXXS - X - X - X - X - GGF

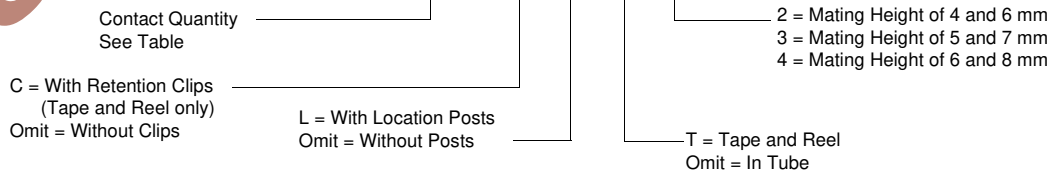

TS-1149-02
Sheet 5 of 5

3M CONTINUED 10/20/2011

Important Notice

All statements, technical information, and recommendations related to 3M's products are based on information believed to be reliable, but the accuracy or completeness is not guaranteed. Before using this product, you must evaluate it and determine if it is suitable for your intended application. You assume all risks and liability associated with such use. Any statements related to the product which are not contained in 3M's current publications, or any contrary statements contained on your purchase order shall have no force or effect unless expressly agreed upon, in writing, by an authorized officer of 3M.



3M Electronics

6801 River Place Blvd.
Austin, TX 78726-9000
800/225-5373
www.3M.com/electronics

Warranty; Limited Remedy; Limited Liability.

This product will be free from defects in material and manufacture for a period of one (1) year from the time of purchase. **3M MAKES NO OTHER WARRANTIES INCLUDING, BUT NOT LIMITED TO, ANY IMPLIED WARRANTY OF MERCHANTABILITY OR FITNESS FOR A PARTICULAR PURPOSE.** If this product is defective within the warranty period stated above, your exclusive remedy shall be, at 3M's option, to replace or repair the 3M product or refund the purchase price of the 3M product. **Except where prohibited by law, 3M will not be liable for any indirect, special, incidental or consequential loss or damage arising from this 3M product, regardless of the legal theory asserted.**



Minimum 10%
Post-Consumer Fiber

Printed in USA.

© 3M 2006