

Mechanical Dimensions: Inches [mm]

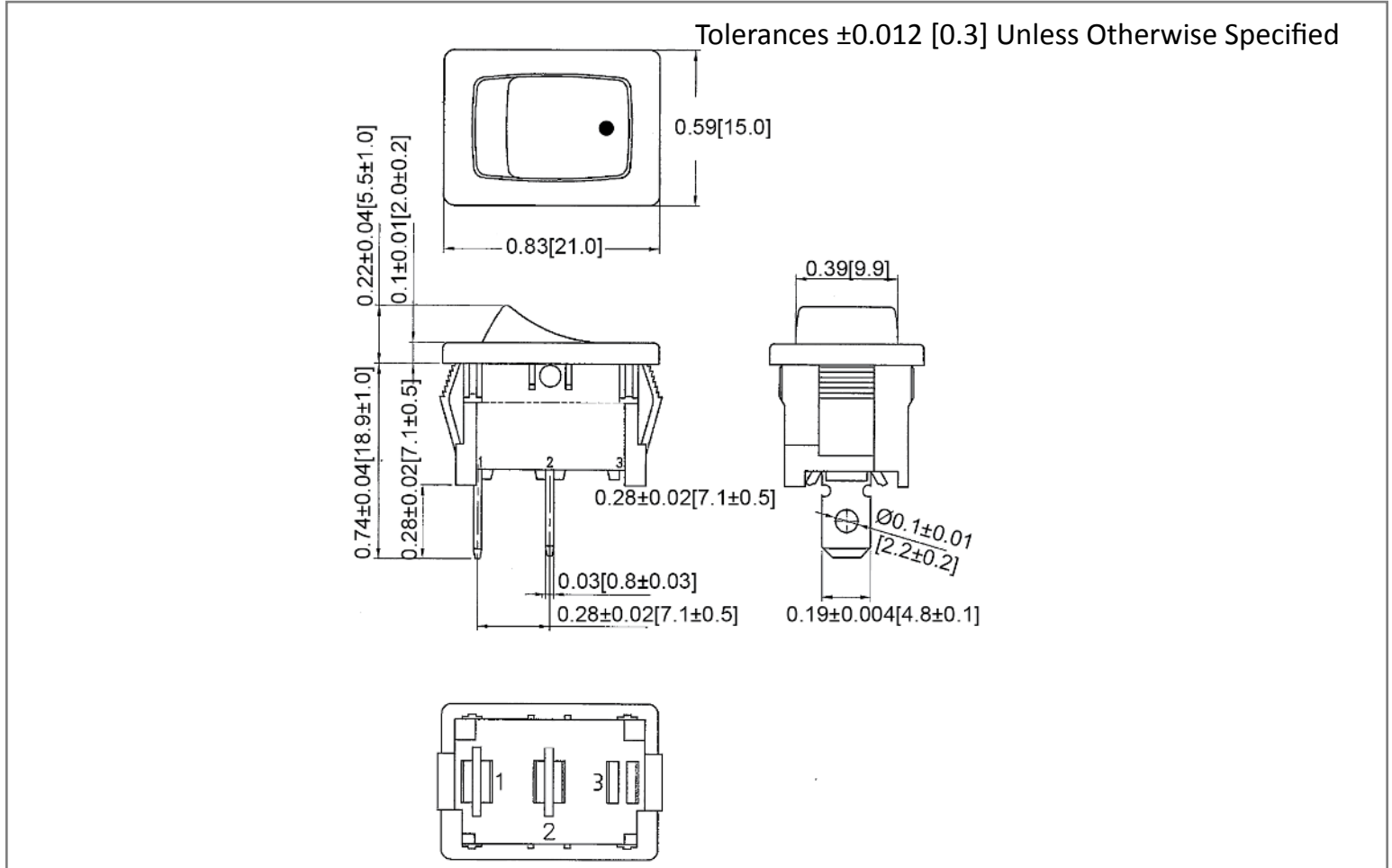

Mounting Hole

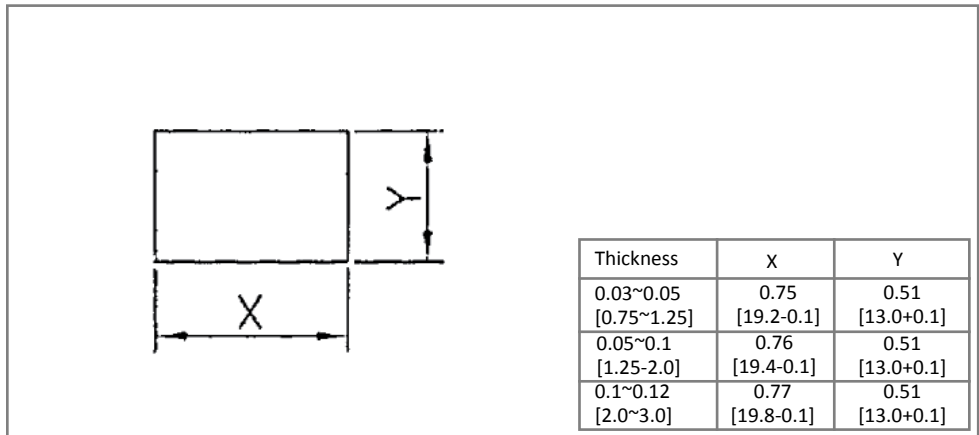

Circuit Diagram

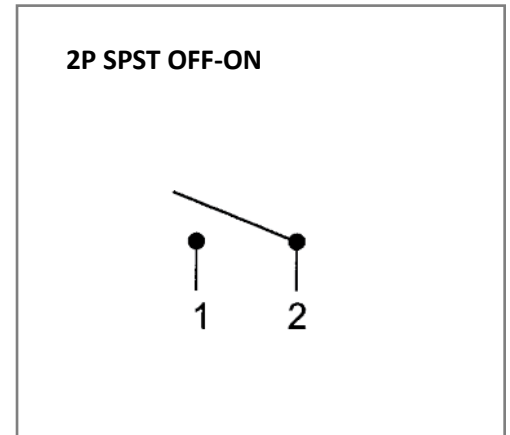

Electrical Specifications

Rating	16A 125V AC 1/3HP, 10A 250V AC 1/2HP 16(4)A 125/250V AC
Contact Resistance	50m ohm Max
Insulation Resistance	DC 500V 100M ohm Min
Dielectric Strength	AC 1500V 1 minute
Operation Temperature	-25°C~85°C

Material Specifications

Frame	Black, Nylon 66
Actuator	Black, Nylon 66
Printed	White, hot stamping

Rev	Date of issue	Revision Notes	Designed	Approved
B	06-08-2021	Initial Drawing	RC	OF