

MINIPAK* HDL Power Connectors

NOTE

All numerical values are in metric units [with U.S. customary units in brackets]. Dimensions are in millimeters [and inches]. Unless otherwise specified, dimensions have a tolerance of ± 0.13 mm [$\pm .005$ in.] and angles have a tolerance of $\pm 2^\circ$. Figures and illustrations are for identification only and are not drawn to scale.

1. INTRODUCTION

This specification covers the requirements for application of MINIPAK HDL power connectors onto printed circuit (pc) boards specifically designed for modular hot-swappable power distribution systems. These connectors consist of right-angle plug assemblies, right-angle receptacle assemblies, and vertical receptacle assemblies. The connectors have precision formed compliant pin contacts that can be used either for press-fit application or wave soldering application. Each connector consists of a housing with power modules containing one row of power (either blade or socket) contacts and signal modules containing 5 rows of signal (either pin or socket) contacts.

When corresponding with TE Connectivity Personnel, use the terminology provided in this specification to facilitate inquiries for information. Basic terms and features of this product are provided in Figure 1.

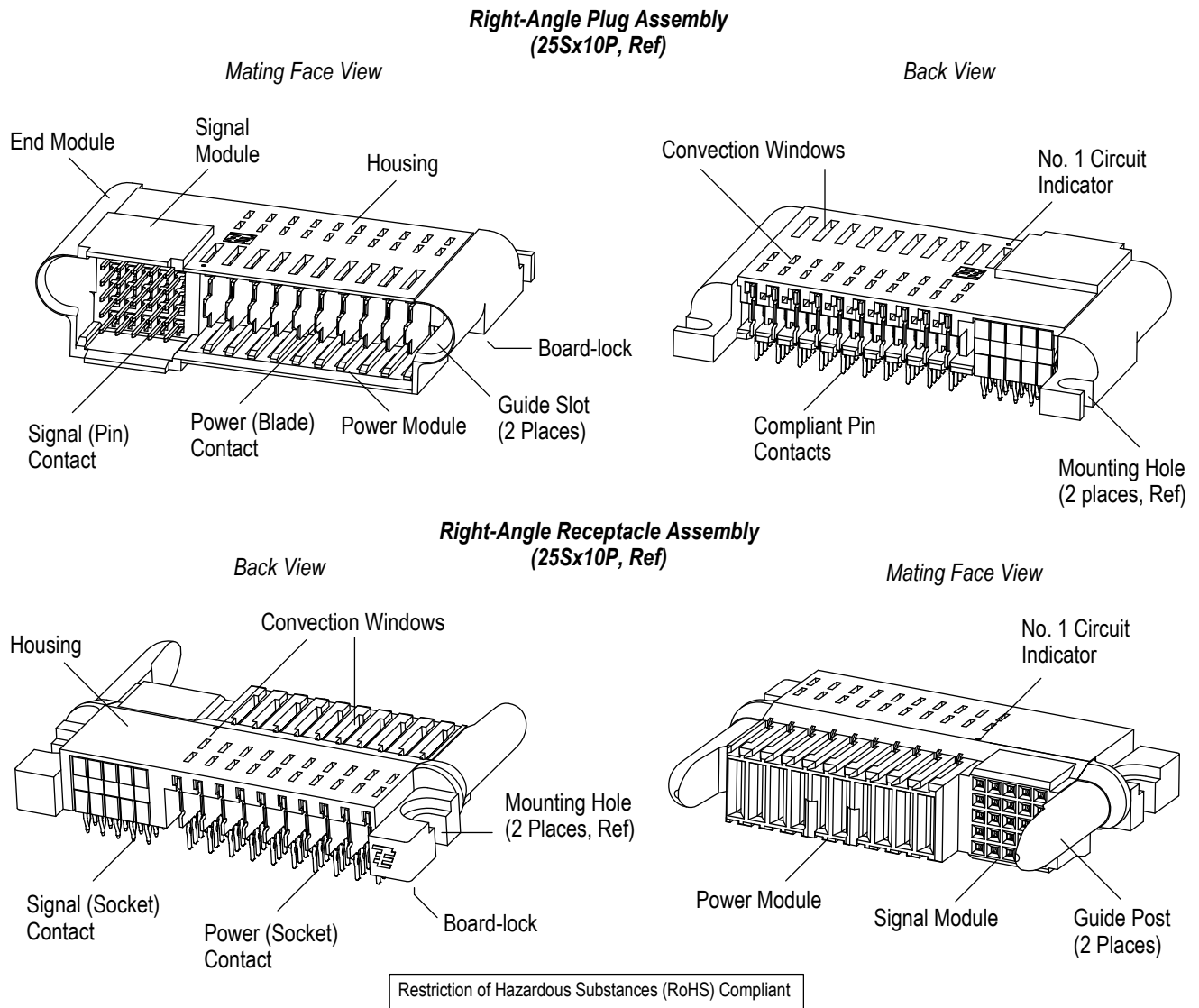

Figure 1 (cont'd)

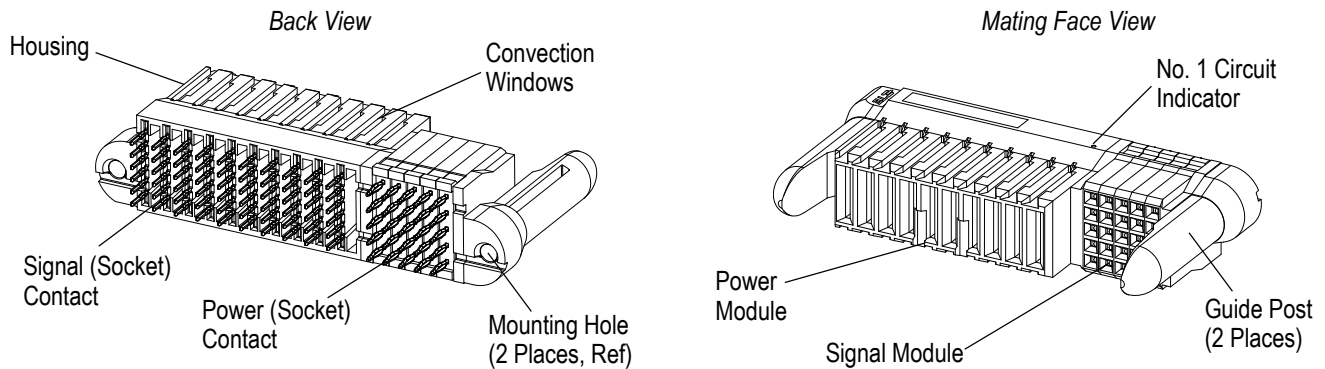

Figure 1 (end)

The connectors are available in two contact mating lengths to provide 2 levels of mating sequences: the power contacts have Level 1: mate-first break-last (MFBL) and Level 2: standard, and the signal contacts have Level 2: standard and Level 3: mate-last break-first (MLBF). Each power module has a contact centerline spacing of 2.75 mm [.108 in.]. Each signal module has a contact centerline spacing of 2.00 mm [.078 in.].

Each housing has an embossed dot to indicate the No. 1 circuit. The maximum overall length allowed for the connector is 101 mm [4 in.]. Thirty power contacts (without signal contacts) or combinations of up to 24 power contacts and 40 signal contacts can be used-provided the maximum allowable length is not exceeded.



NOTE

The amount of power and signal contacts in a connector is customer specified. Any connector configuration can be designed to meet customer requirements-provided it is within the limitations stated in this document. The connector configuration is described by reading left to right on the plug and right to left on the receptacle. See Figure 1.

End modules are available with features that provide blind mating, alignment, and polarization. End modules contain a guide post (for receptacles only) or guide slot (for plugs only) and a board-lock (for wave soldering application), and/or mounting hole (for press fit application). Guides have rounded edges for ease of mating and are positioned to prevent improper mating of connectors. The board-locks and mounting holes (which accept commercially-available standard screws) help to align the connector to the pc board for installation then secure the connector to the pc board. Convection windows located on the housing provide air flow for power modules.

The connectors are supplied in tray form for manual placement.

2. REFERENCE MATERIAL

2.1. Revision Summary

- Updated document to corporate requirements
- Changed or added new text to Section 1, INTRODUCTION; Paragraph 3.2; table in Figure 3; Figure 5
- Added new artwork to Figures 1 and 15
- Added new part numbers to Paragraph 2.2

2.2. Customer Assistance

Reference Product Base Part Numbers 1926730 (plug assembly), 1926739 (receptacle assembly), and 1892787 (vertical receptacle assembly), and Product Code K431 are representative of MINIPAK HDL power connectors. Use of these numbers will identify the product line and help you to obtain product and tooling information. Such information can be obtained through a local TE Representative, by visiting our website at www.te.com, or by calling PRODUCT INFORMATION or the TOOLING ASSISTANCE CENTER at the numbers at the bottom of page 1.

2.3. Drawings

Customer Drawings for product part numbers are available from the service network. If there is a conflict between the information contained in the Customer Drawings and this specification or with any other technical documentation supplied, the information contained in the Customer Drawings takes priority.

2.4. Manuals

Manual 402-40 can be used as a guide to soldering. This manual provides information on various flux types and characteristics with the commercial designation and flux removal procedures. A checklist is included in the manual as a guide for information on soldering problems.

2.5. Specifications

Product Specification 108-2325 provides product performance and test information. Quality Specification 501-703 provides specifics that support conclusion of the test.

Test Specification 109-11 provides solderability requirements and evaluation methods. Workmanship Specification 101-21 provides solder fillet requirements.

2.6. Standards

These connectors are compatible with Military Standard (MIL-STD)-2166, "Connectors, Electrical, Compliant Pin".

3. REQUIREMENTS

3.1. Safety

Do not stack product shipping containers so high that the trays buckle or deform.

3.2. Material

The housing is made of glass-filled liquid crystal polymer. The signal contacts are made of phosphor bronze, and the power contacts are made of high-conductivity copper alloy. Both are under-plated with nickel; compliant pin is plated with tin over nickel. The mating area is gold flash over palladium nickel or gold. Board-locks are made of plated copper alloy.

3.3. Limitations

These connectors are designed to operate in a temperature range of -40° to 125°C [-40° to 257°F].

Voltage ratings for these connectors according to contact centerline spacing and circuit pad travel are given in Figure 2.

These voltage ratings are based on nominal circuit pad diameters of 1.12 mm [.0441 in.] for press-fit application and 1.41 mm [.0556 in.] for solder application and Underwriters Laboratories Inc. (UL), Pollution Group II, Material Group IIIb. That material group has a comparative tracking index (CTI) of $100 \leq CTI < 175$.

CONTACT			MAXIMUM VOLTAGE RATING IN AC (RMS) OR DC			
TYPE	FUNCTION	PITCH	WITHIN PRIMARY CIRCUITS	PRIMARY TO SECONDARY CIRCUITS	PRIMARY TO GROUND CIRCUITS	WITHIN SECONDARY CIRCUITS
Press-Fit	Signal	2.00 [.0787]	---	---	---	60●
	Power	2.75 [.1083]	150	150	150	150
		5.50 [.2165]	400	---	400	400
Solder	Signal	2.00 [.0787]	---	---	---	60●
	Power	2.75 [.1083]	100	100	100	100
		5.50 [.2165]	400	---	400	400

● Safety Extra Low Voltage (SELV) Circuits

Figure 2

3.4. Storage

A. Ultraviolet Light

Prolonged exposure to ultraviolet light may deteriorate the chemical composition used in the product material.

B. Shelf Life

The product should remain in the shipping containers until ready for use to prevent deformation to components. The product should be used on a first in, first out basis to avoid storage contamination that could adversely affect performance.

C. Chemical Exposure

Do not store product near any chemical listed below as they may cause stress corrosion cracking in the material.

Alkalies	Ammonia	Citrates	Phosphates	Citrates	Sulfur Compounds
Amines	Carbonates	Nitrites	Sulfur Nitrites		Tartrates

3.5. PC Board

A. Material and Thickness

The pc board material shall be glass epoxy (FR-4 or G-10). The minimum pc board thickness for press-fit application is 1.40 mm [.053 in.]. The pc board thickness range for solder application is 1.40 mm through 2.62 mm [.055 through .103 in.].

B. Hole Dimensions, Plating, and Durability

The contact holes must be drilled and plated through to specific dimensions to prevent stubbing during placement of the connector on the pc board and to ensure optimum continuity for circuits. If applicable, holes for the board-locks or mounting hardware may be used with or without plated through holes. The drilled hole size, plating types, plating thickness, and finished hole size must be as stated to provide unrestricted insertion. See Figure 3.

For connectors used for press-fit application, the contact holes cannot withstand connector removal more than three times. The radius of any pc board hole must not increase more than 0.038 [.0015] or decrease less than 0.0508 mm [.002 in.].

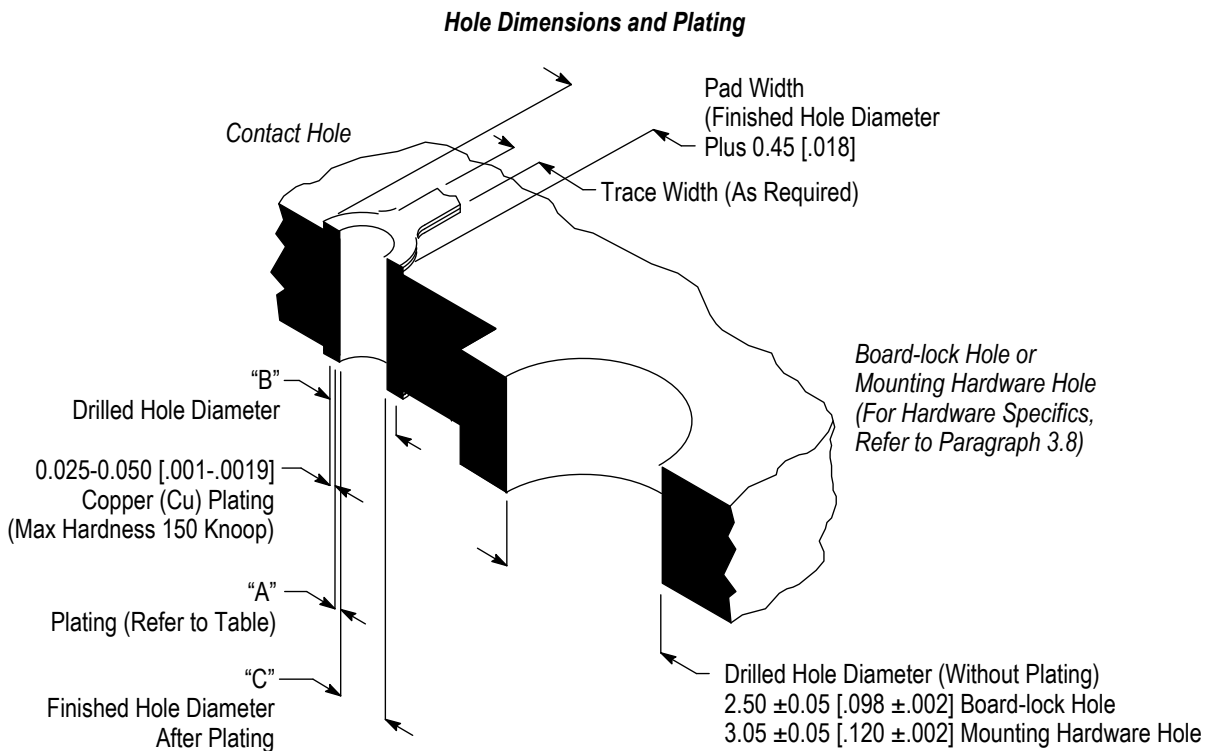

Figure 3 (cont'd)

APPLICATION	DIMENSION			
	"A"		DRILL "B"	FINISH "C" (Nominal, Ref)
	Surface Finish	Thickness		
Press-Fit	Immersion Gold (Au) Over Nickel (Ni)	0.00127 [.00005] Min	0.71-0.75 [.028-.0295]	0.65 [.0255]
	Hot Air Solder Leveling (HASL) TIN (Sn) Tin-Lead (Sn Pb)	0.004-0.015 [.00016-.0006]	0.68-0.72 [.0267-.0283]	0.61 [.0240]
	Immersion Sn	0.0005- [.00002] Min		
	Organic Solderability Preservative (OSP)	0.0002-0.0005 [.000008-.00002]		
	Immersion Silver (Ag)	0.0001 [.000004] Min		
Solder	Sn Pb	0.008 [.0003] Min	0.97-1.01 [.0382-0.398]	0.90 [.0354]
	Immersion Sn	0.0005-0.004 [.00002-.0015]		
	Organic Solderability Preservative (OSP)	0.0002-0.0005 [.000008-.00002]		
	Immersion Silver (Ag)	0.0001 [.000004]		

Figure 3 (end)

C. Pads

The pc board circuit pads must be solderable in accordance with Test Specification 109-11.

D. Layout

The holes in the pc board must be precisely located to ensure proper placement and optimum performance. The pc board layout must be designed using the dimensions provided on the customer drawing for the specific connector. A sample of the recommended pc board layout is shown in Figure 4.

**Sample Recommended PC Board Layout
As Viewed from Connector Side
(25Sx10P Plug Assembly Shown)**

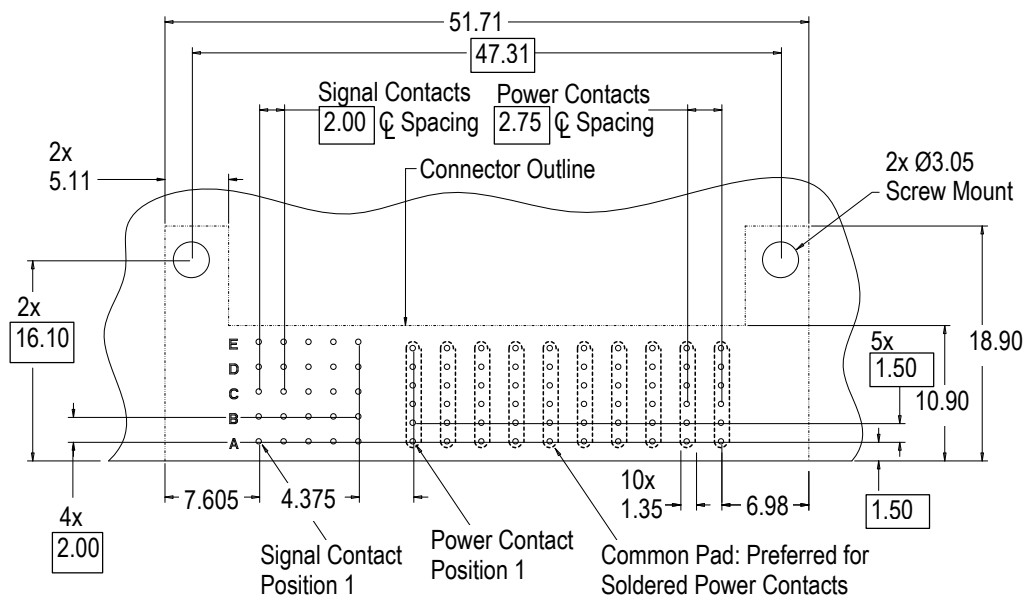

Figure 4

3.6. Connector Spacing

Care must be used to avoid interference between adjacent connectors and other components.

3.7. Connector Placement



CAUTION

Connectors should be handled only by the housing to avoid deformation, contamination, or damage to the contacts.

A. Registration

When placing connectors on the pc board, contacts and, if applicable, board-locks or mounting screws must be aligned and started into the matching holes before seating the connector onto the pc board.

B. Insertion Force

The force required to seat the connector onto the pc board can be calculated by:

- Number of power contacts x maximum insertion force per power contact N [lb] = insertion force N [lb]
- Number of signal contacts x maximum insertion force per signal contact N [lb] = insertion force N [lb]
- Number of connector board-locks x maximum insertion force per board-lock N [lb] = insertion force N [lb]

The maximum amount of insertion force per contact and board-lock is given in Figure 5.

MAXIMUM INSERTION FORCE (N [lb])		
PER POWER CONTACT	PER SIGNAL CONTACT	PER BOARD-LOCK (If Applicable)
267 [60]	44.5 [10]	27 [6]

Figure 5

3.8. Mounting Hardware

Connectors with mounting holes can be secured to the pc board using commercially-available standard screws. The screw size and maximum torque (applied to the mating face of the connector) is provided in Figure 6.



NOTE

Typically, this method of mounting (or hold-down) serves connectors used for soldering application and without board-locks. The hardware must be installed BEFORE soldering.

SCREW		MAXIMUM TORQUE Nm [in.-lb] (Applied to Mating Face)
SIZE	HEAD DIAMETER (Maximum)	
No. 4	7.37 [.290]	0.57 [5]

Figure 6

3.9. Soldering

Observe guidelines and procedures when soldering contacts. Contact solder tails must be soldered, cleaned, and dried according to the following:

A. Flux Selection

Contact solder tails must be fluxed prior to soldering with a mildly active, rosin base flux. Selection of the flux will depend on the type of pc board and other components mounted on the board. Additionally, the flux must be compatible with the wave solder line, manufacturing, health, and safety requirements. Flux that is compatible with these connectors are provided in Figure 7.

FLUX TYPE	ACTIVITY	RESIDUE	COMMERCIAL DESIGNATION	
			KESTER FLUX	ALPHA FLUX
RMA	Mild	Noncorrosive	186	611

Figure 7

KESTER and ALPHA are trademarks of their respective companies.

B. Solder Mask

A solder mask is **MUST** be applied over the trace of any connector component hanging below the bottom of the pc board to prevent bridging and wicking of solder away from the contact solder tines. A heat-resistant solder mask is recommended.



CAUTION

If bridging or wicking occurs, the trace must be repaired.

C. Process

The connectors must be soldered using lead-free wave soldering or equivalent soldering techniques. Refer to Manual 402-40 for soldering guidelines. The temperatures and exposure time shall be as specified in Figure 8.

It is recommended that the pc board be placed on its side during the soldering process.

SOLDERING PROCESS	TYPE	WAVE TEMPERATURE	TIME (At Max Temperature)
Wave	Lead-Free	265°C [509°F]	10 Seconds

Figure 8

D. Cleaning

After soldering, removal of fluxes, residues, and activators is necessary. Consult with the supplier of the solder and flux for recommended cleaning solvents. Cleaners must be free of dissolved flux and other contaminants. Common cleaning solvents that will not the affect connectors for the time and temperature specified are listed in Figure 9.



DANGER

Consideration must be given to toxicity and other safety requirements recommended by the solvent manufacturer. Refer to the manufacturer's Material Safety Data Sheet (MSDS) for characteristics and handling of cleaners. Trichloroethylene and Methylene Chloride is not recommended because of harmful occupational and environmental effects. Both are carcinogenic (cancer-causing).



CAUTION

Even when using "no clean" solder paste, it is imperative that the contact interface be kept clean of flux and residue, since it acts as an insulator. Flux may migrate under certain conditions with elevated temperatures and therefore, cleaning is necessary.

The cleaning process must be accomplished by hand.



CAUTION

*Lubricant at the mating interface **MUST NOT** be removed.*

CLEANER		TIME (Minutes)	TEMPERATURE (Max)
NAME	TYPE		
ALPHA 2110	Aqueous	1	132°C [270°F]
BIOACT EC-7	Solvent	5	100°C [212°F]
Butyl CARBITOL	Solvent	1	Ambient Room
Isopropyl Alcohol	Solvent	5	100°C [212°F]
KESTER 5778	Aqueous		
KESTER 5779	Aqueous		
LONCOTERGE 520	Aqueous		
LONCOTERGE 530	Aqueous		
Terpene	Solvent		

Figure 9

ALPHA, BIOACT, CARBITOL, LONCOTERGE, and KESTER are trademarks of their respective owners.



NOTE

If a particular solvent is not listed, contact *PRODUCT INFORMATION* at the number at the bottom of page 1.

E. Drying

When drying cleaned connectors and pc boards, make certain that temperature limitations are not exceeded: -40° to 125°C [-40° to 257°F]. Excessive temperatures may cause housing degradation.

3.10. Checking Installed Connector

A. Using Contacts for Press-Fit Application

The entire “eye” of each contact must be within the pc board hole. The housing must be seated on the pc board within the dimension provided in Figure 10, Detail A.

B. Using Contacts for Soldering Application

All solder joints should conform to those specified in Workmanship Specification 101-21 and all other requirements specified in this document. Solder fillets must be evenly formed around each contact solder tail. There must be no visible skips or voids. The housing must be seated on the pc board within the dimension provided in Figure 10, Detail B.

Checking Installed Connector

NOTE: Requirements Apply Equally to All connectors.

Plug Assembly Used for Press-Fit Application

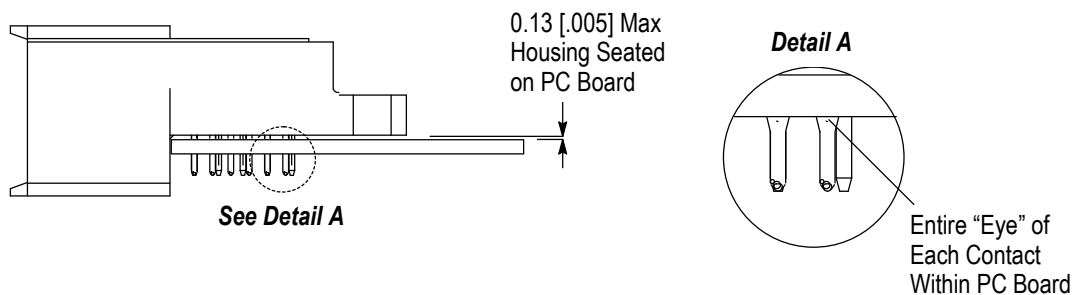

Receptacle Assembly Used for Soldering Application

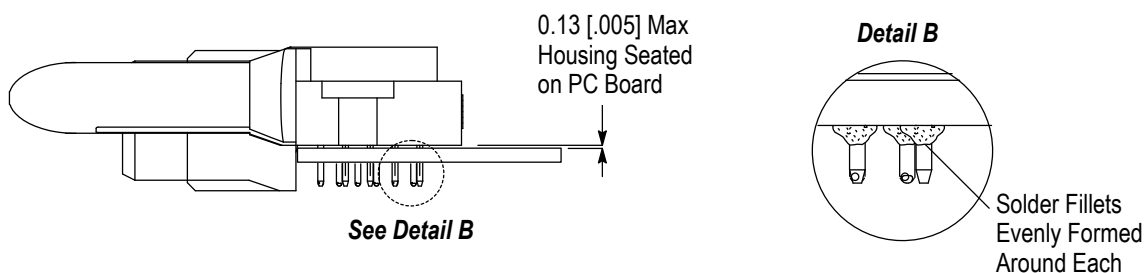

Figure 10

3.11. Connector Mating



CAUTION

Connectors should be handled only by the housing to avoid deformation, contamination, or damage to the contacts.

A. Polarization

When mating the connectors, polarization is provided by matching the guide posts of the receptacle with the guide slots of the plug.

B. Mating Force

The maximum amount of mating force per contact is given in Figure 11.

CONTACT	MAXIMUM MATING FORCE PER CONTACT (N [oz.])
Power	3 [10.8]
Signal	1.65 [5.9]

Figure 11

C. Mating Lengths

Contact mating lengths available for the connectors are listed in Figure 12.

Mating Length

Power Contacts

Mating Level 1

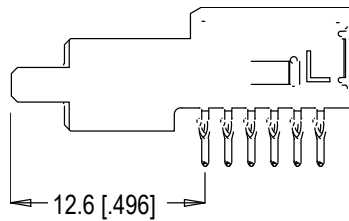

Mating Level 2△

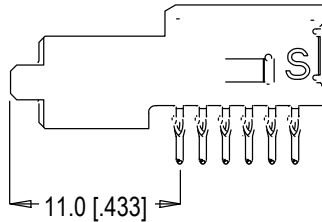

Signal Contacts

Mating Level 2△

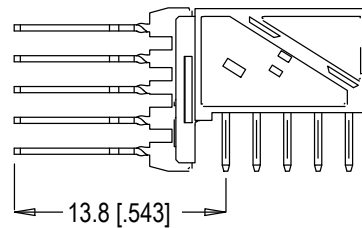

Mating Mixed△

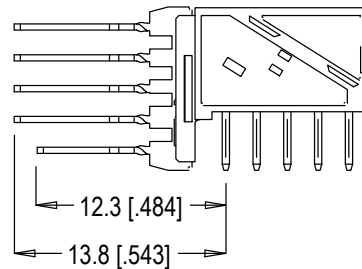

Mating Level 3

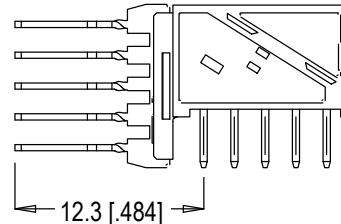

△The offset distance between Mating Level 2 for power contacts and Mating Level 2 for signal contacts is not enough to consider these as separate levels.

CONTACT TYPE	MATING LENGTH	MATING LEVEL
Power	MFBL (Pre-Mate)	1
	Standard	2
Signal	Standard	2
	MLBF (Post-mate)	3

Figure 12

D. Mating Distance and Wipe Length

The connectors provide sequencing among contacts with 3 mating levels. The mating distance, measured from the receptacle mating face to the plug mating face at the point of electrical engagement, depends on the contact (power or signal) and mating length (standard, MFBL, or MLBF) of the mating connectors.

Wipe length for these connectors is defined as that portion (length) of the mating contacts that touches (wipes) from the point of engagement to the point of being fully mated. The wipe length depends on the contact (power or signal) and mating length (standard, MFBL, or MLBF) of each individual contact.

The mating distance and minimum wipe length at the mating level for power and signal contacts is listed in Figure 13.

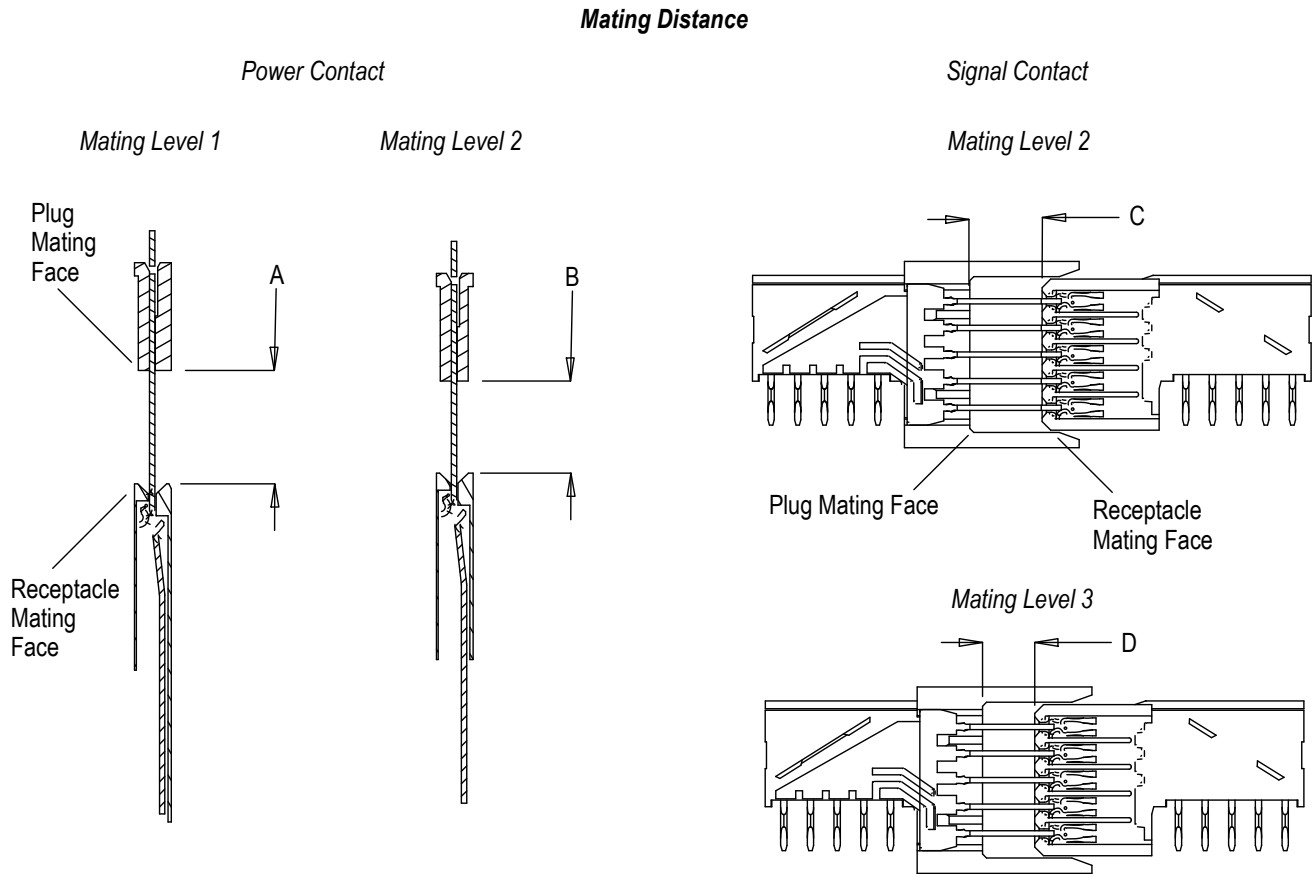

CONTACT	MATING LENGTH	MATING LEVEL	MATING DISTANCE			WIPE LENGTH
			DIMENSION	FIRST MATE	RELIABLE MATE	
Power	MFBL (Pre-Mate)	1	A	8.52 [.3354]	6.68 [.263]	6 [.235]
	Standard	2	B	6.92 [.2724]	5.08 [.200]	4.4 [.173]
Signal	Standard	2	C	5.42 [.2134]	5.01 [.197]	3.75 [.148]
	MLBF 9Post-mate)	3	D	3.92 [.1543]	3.51 [.138]	2.25 [.089]

Figure 13

E. Misalignment

When mating connectors, side-to-side and up-and-down misalignment is allowed to the dimensions given in Figure 14.

Misalignment

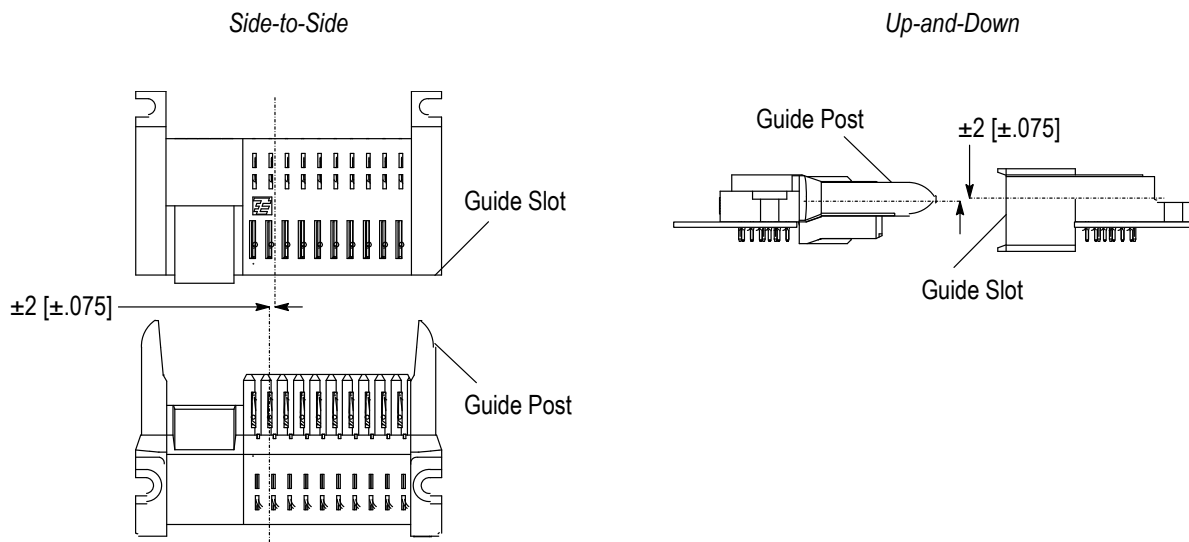

Figure 14

F. Mating Dimension

When fully engaged, the dimension between the first contact of the receptacle and the first contact of the plug meet the dimension given in Figure 15.

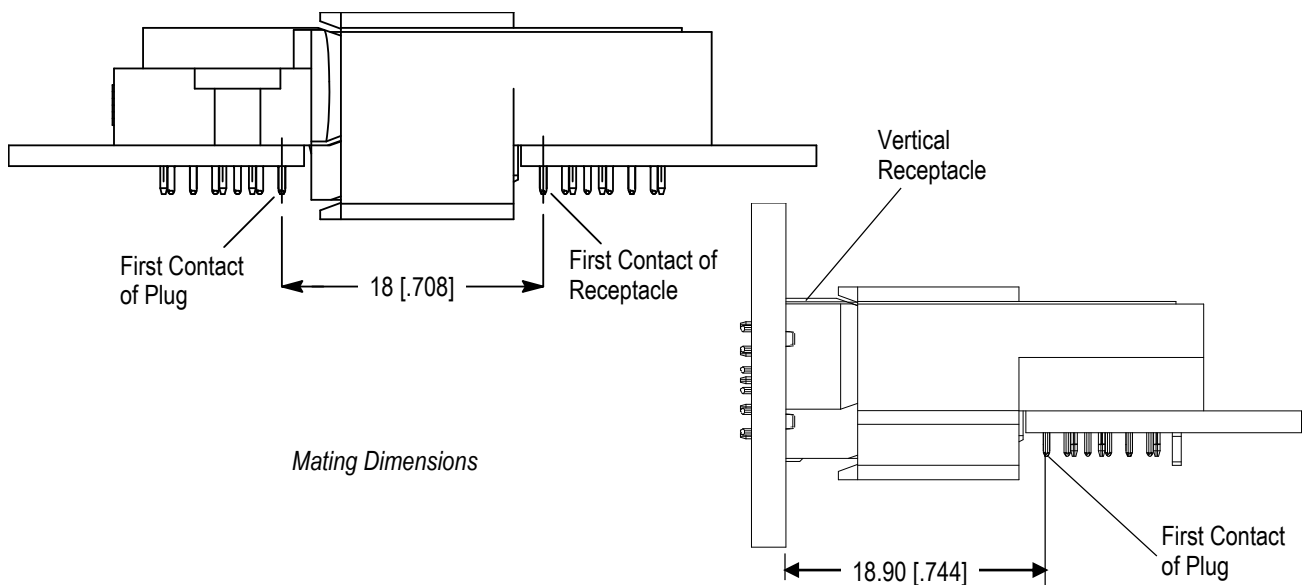

Figure 15

G. Durability

The connectors can withstand 250 mating cycles.

3.12. Circuit Testing

Unmated receptacles and mated plugs must be tested against hazardous voltages using the test probe specified in UL 1950. Specific areas of the connector must be tested as indicated in Figure 16.

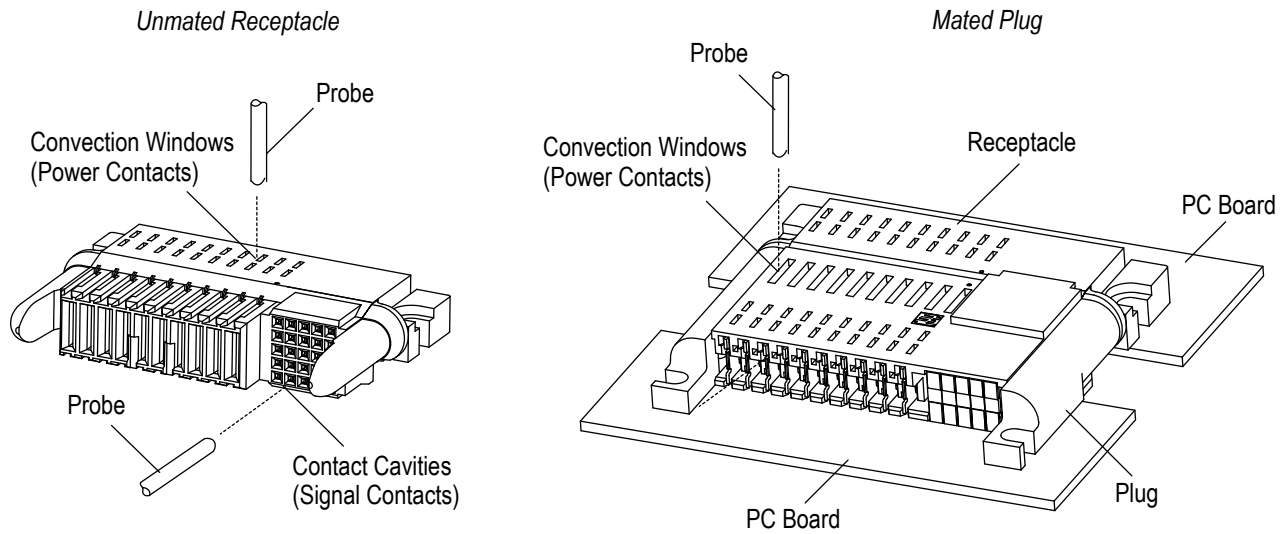

Figure 16

3.13. Connector Removal

A. Used for Press-Fit Application

These connectors must be removed from the pc board using a push bar (or flat rock) and pc board support.



CAUTION

For reparability, the tips of the contacts must extend below the surface of the pc board by at least 1.02 [.040]; if not, the connector **MUST NOT** be removed from the pc board.

B. Used for Soldering Application

These connectors must be removed from the pc board by standard de-soldering methods. After removal from the board, the connector **MUST NOT** be re-used.

3.14. Repair

These connectors are not repairable. Damaged or defective connectors **MUST NOT** be used.

4. QUALIFICATION

MINIPAK HDL power connectors are Recognized by Underwriters Laboratories (UL) in File E28476.

5. TOOLING

5.1. Connectors Used for Press-Fit Application

Tooling needed to seat connectors with press-fit contacts are shown in Figure 17.

A. Application Tooling

The application tooling (such as a manual arbor press) used to seat these connectors must provide sufficient amount of downward force to insert the contacts into the pc board holes.

B. PC Board Support

A pc board support must be used to prevent bowing of the pc board during the placement of these connectors on the board. The board support must have a flat surface with holes or a channel large enough and deep enough to receive any protruding components. The pc board must be secured to the board support to prevent movement of the board during seating.

The board support must also be used when removing these connectors from the pc board.

C. Flat Rock Tooling

Commercially available bar stock (flat rock tooling) with a flat surface large enough to cover all contacts must be used with the application tooling to seat and remove these connectors.

For removing these connectors from the pc board, it is suggested that the pc board be supported from the connector side.

5.2. Connectors Used for Soldering Application

No tooling is required for placement of the connectors being used for soldering application onto the pc board.

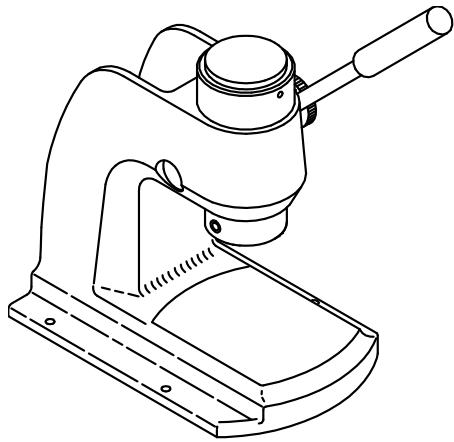

Manual Arbor Press (Typical)

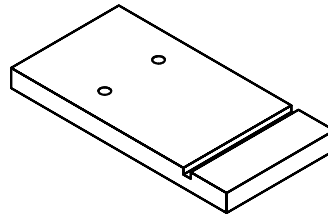

*PC Board Support
(Must be Custom Made)*

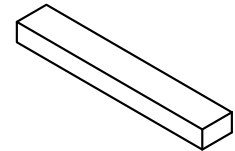

*Flat Rock Tooling
(Must be Custom Made)*

Figure 17

6. VISUAL AID

The illustration below shows a typical application of this product. This illustration should be used by production personnel to ensure a correctly applied product. Applications which DO NOT appear correct should be inspected using the information in the preceding pages of this specification and in the instructional material shipped with the product or tooling.

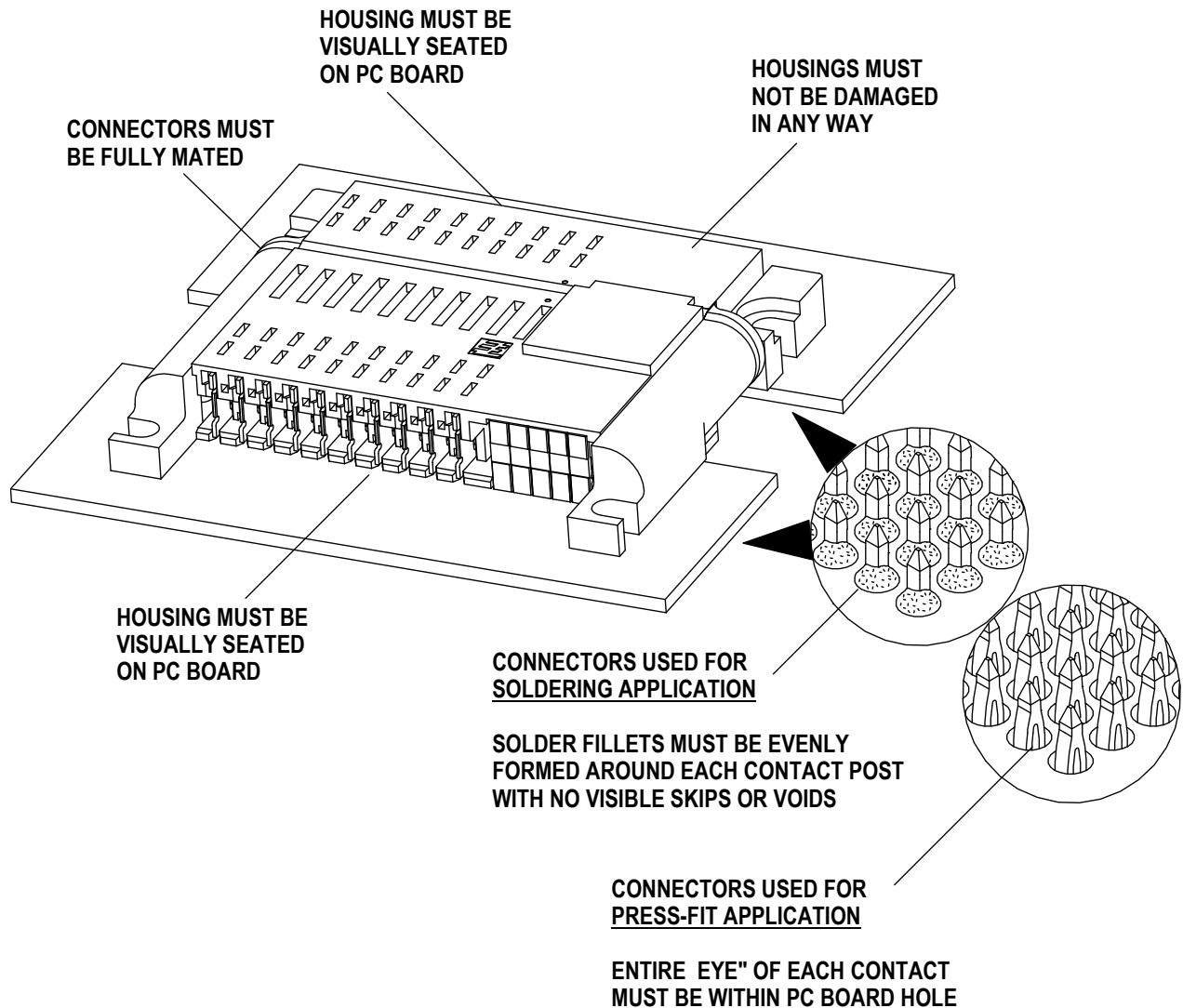

FIGURE 18. VISUAL AID