



ON Semiconductor®

Test Procedure for the NCP1566 12-V/6-A Dc-Dc Converter

Christophe Basso

April 17th 2019

Rev. 1



Board Electrical Schematic

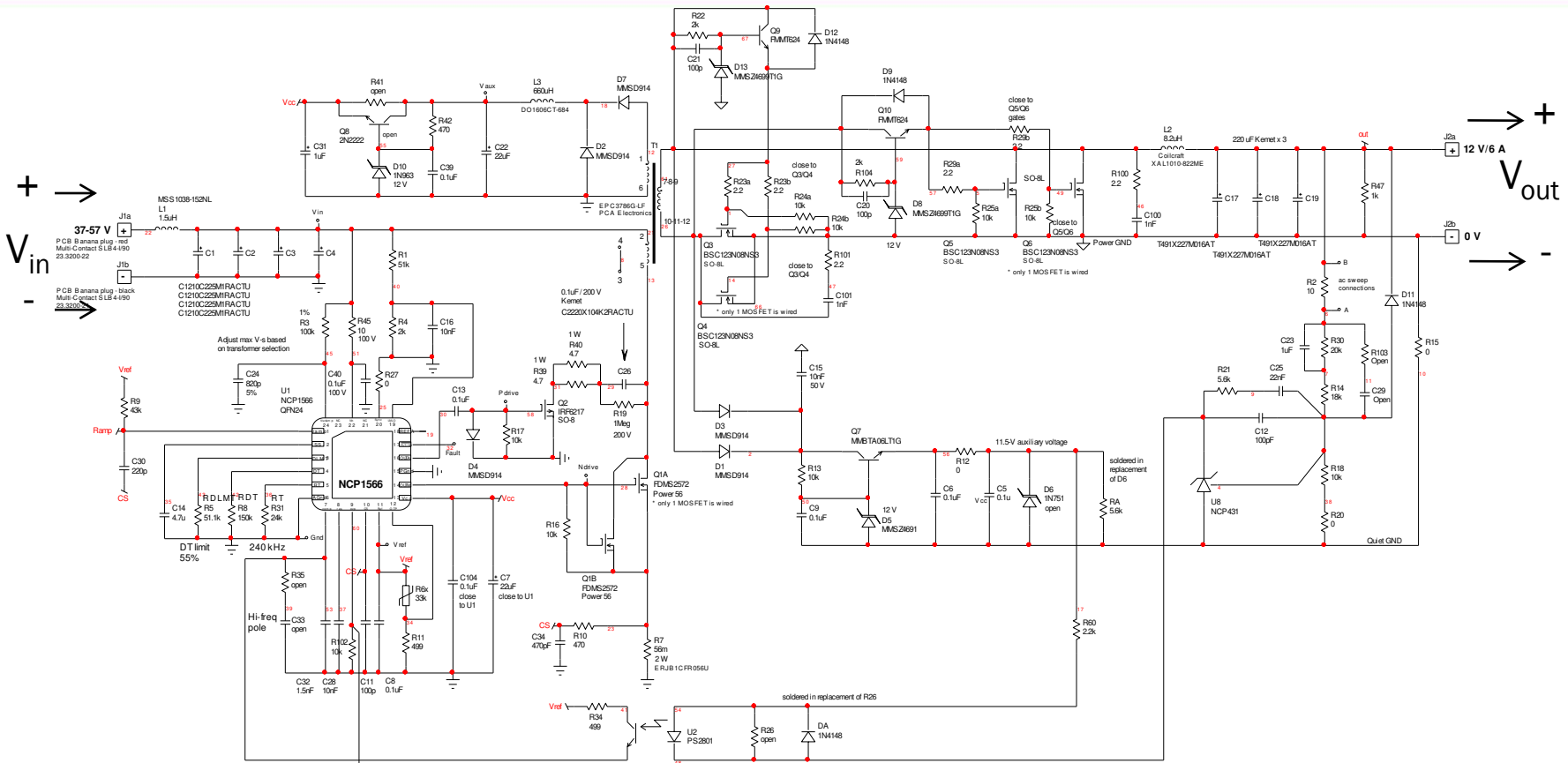

V_{in}

V_{out}

Dc input voltage
36 – 57 V
Max is 72 V

37-57 V 12 V/6 A dc-dc converter

NCP1566 - OVP and sync function
Current-Mode Control

12 V/6 A
Output voltage

ON Semiconductor
Ver f.
Christophe Basso - February 4th 2019



Board Picture

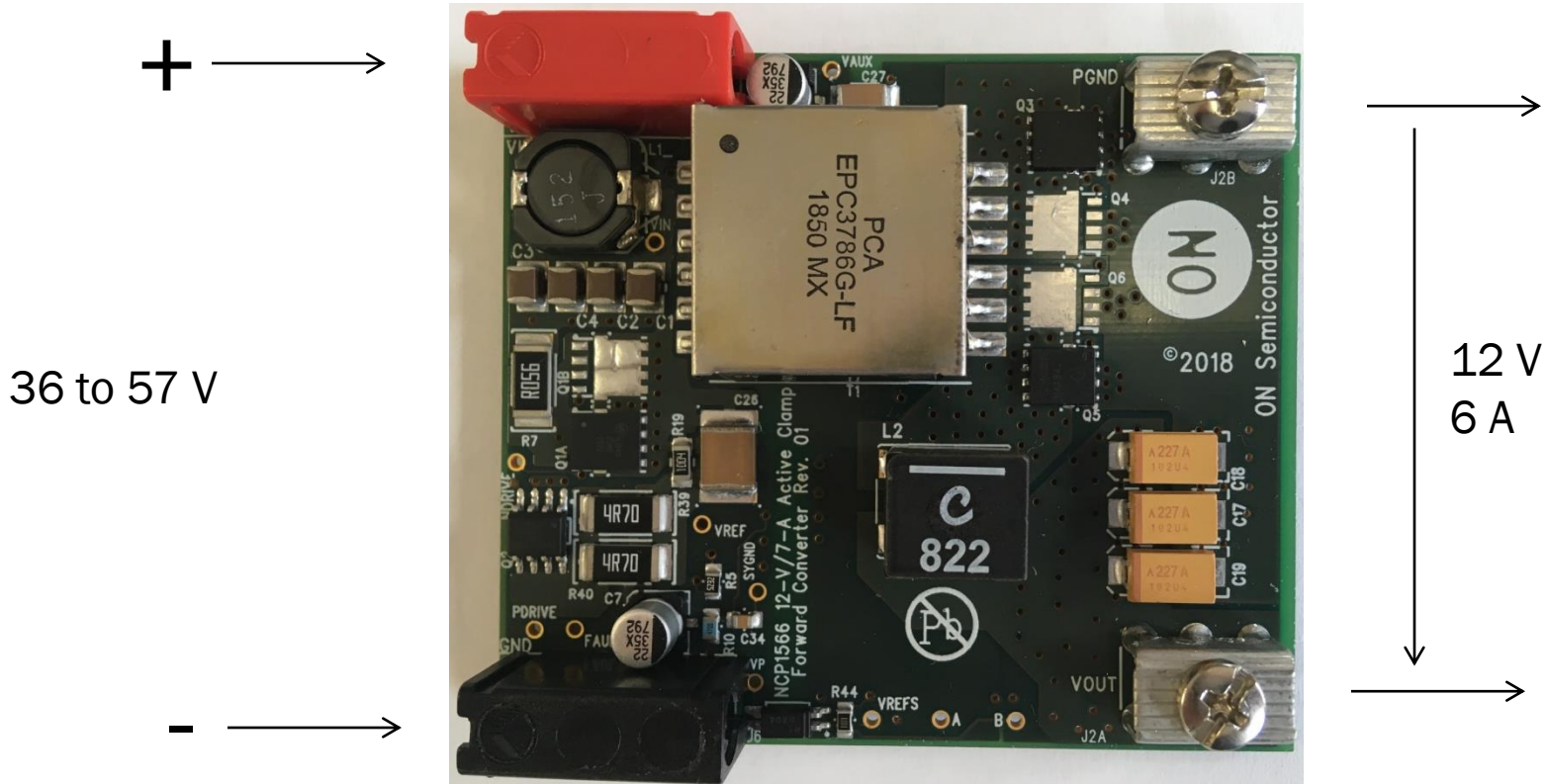

Input voltage is 48 V nominal.
Range is from 36 to 57 V.

Output voltage is 12 V nominal.
Output current is 6 A

NCP1566POEGEVB

Needed Equipment

The needed equipments are the following:

- ❑ a dc voltage source, delivering up to 60 V dc and up to 2 A
 - ❑ a dc load absorbing up to 100 W, $V_{in,max} < 20 \text{ V}$, $I_{out,max} < 10 \text{ A}$
 - ❑ either the above load can display dc V and dc A or separated V and A-meters are necessary
 - ❑ An oscilloscope with single shot capability
- *Kelvin sensing is necessary to connect the load to the board. If no precautions are taken, it is likely that the voltage drop at the load cables ends induces a reading error*

Basic Test Setup

source



load

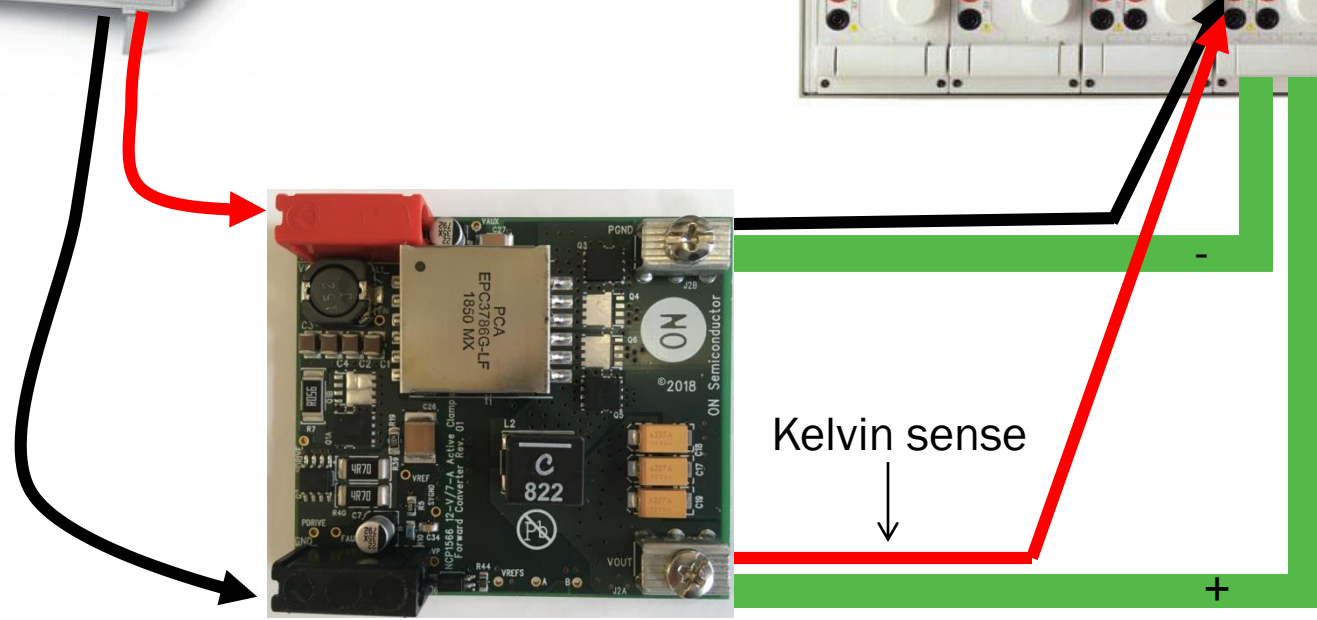
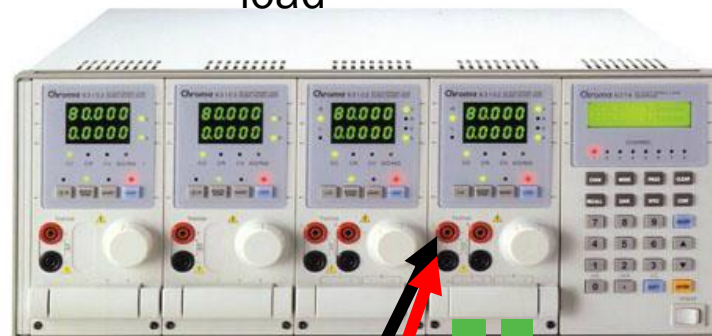

Test n°1

source



load

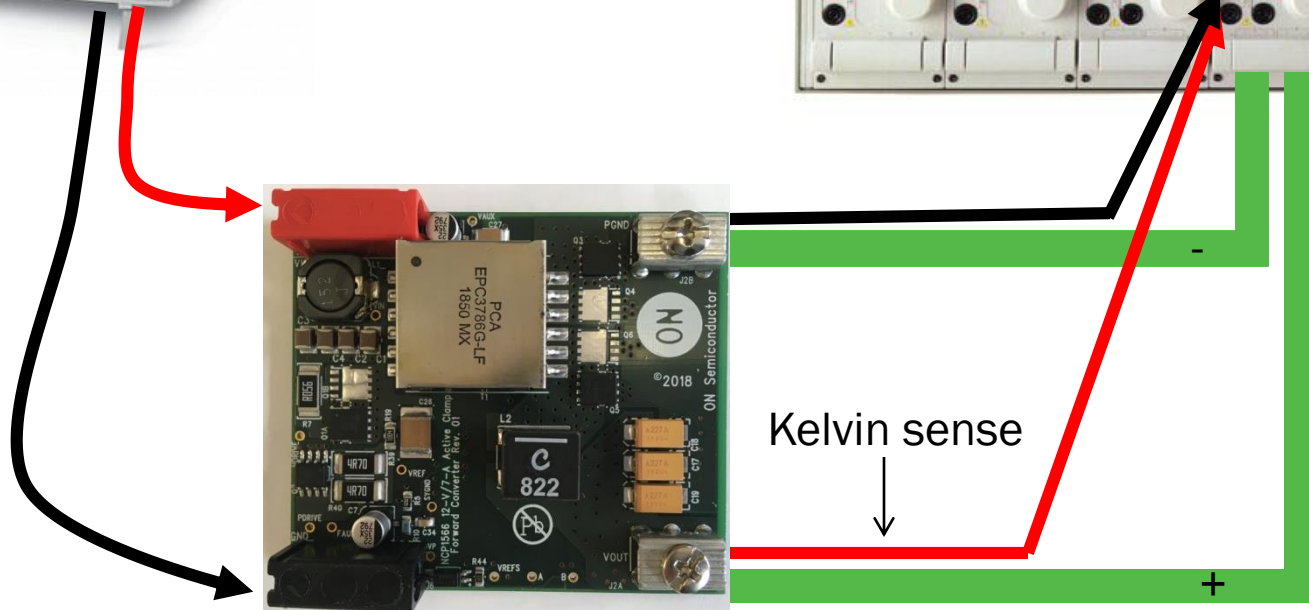
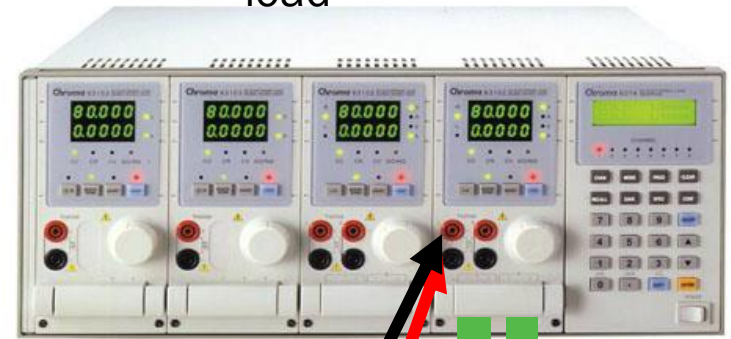

- Start the power supply $V_{in} = 48\text{ V}$ while the load current is 6 A
- Monitor the output voltage on a scope
- Verify the voltage is monotonically rising

Test n°1

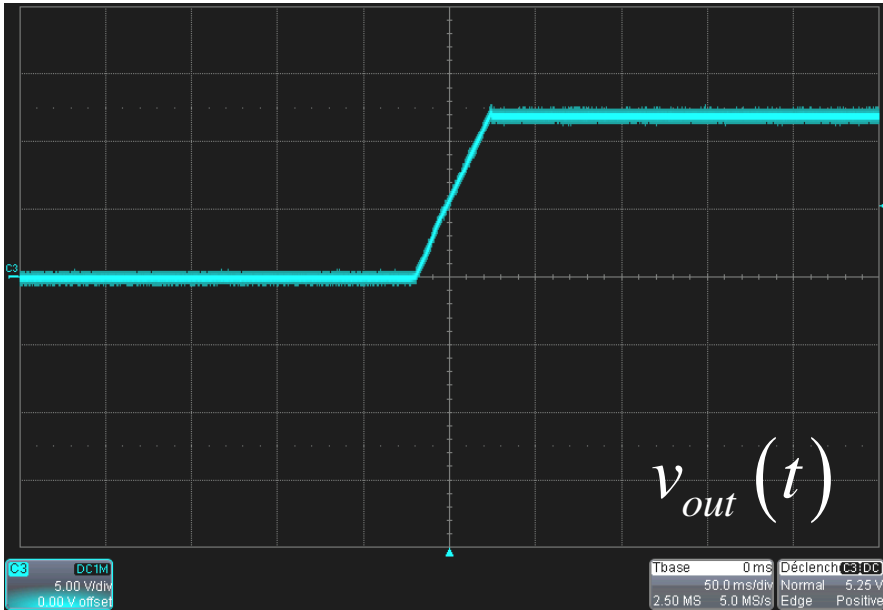

$$V_{in} = 0 \text{ to } 48 \text{ V} - I_{out} = 6 \text{ A}$$

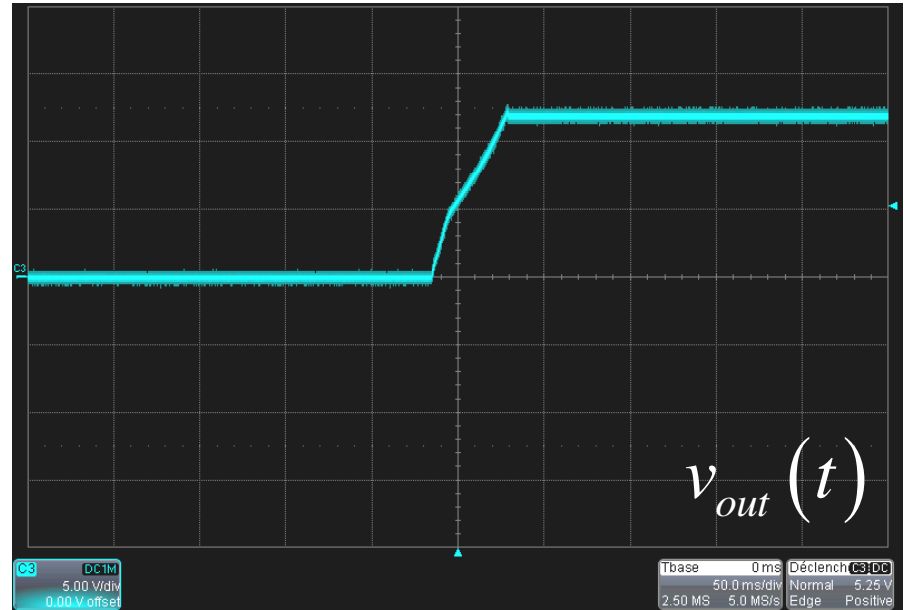

$$V_{in} = 0 \text{ to } 48 \text{ V} - I_{out} = 0 \text{ A}$$

- It is important to verify the absence of negative slope
- Repeat the test for $V_{in} = 36 \text{ V}$ and 57 V
- Change load to 0 A , repeat tests. Wait 10 s between re-starts
- A small glitch at the beginning of the rising edge is acceptable

Test n°2

source



load

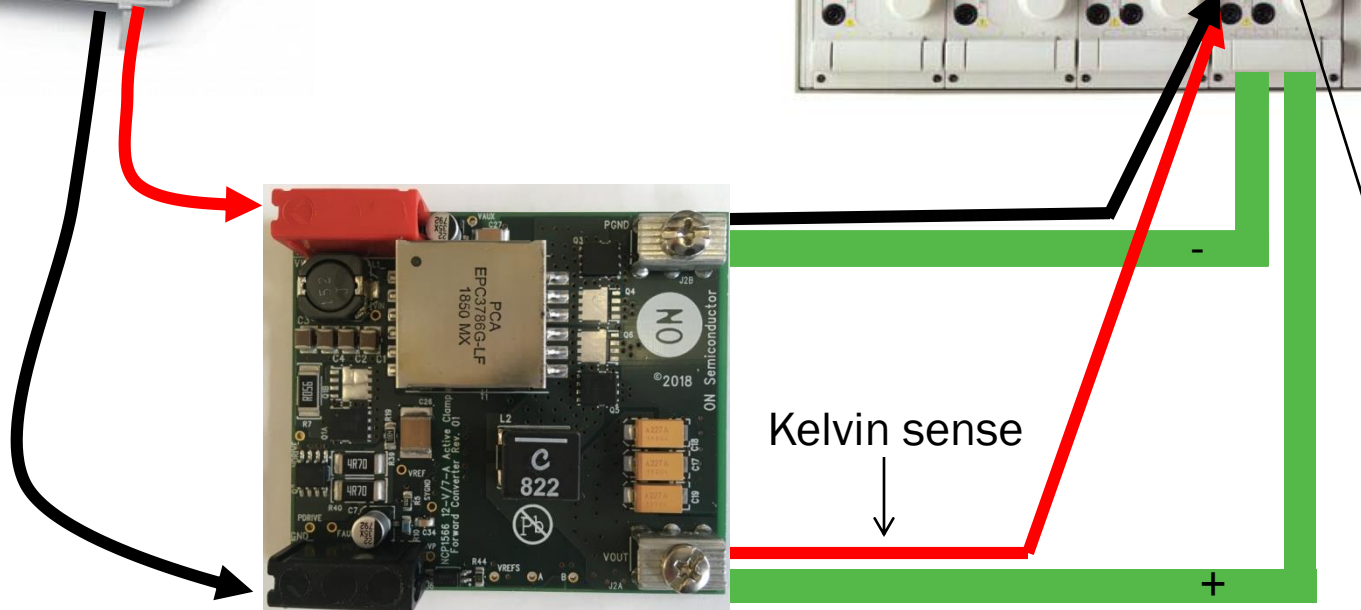
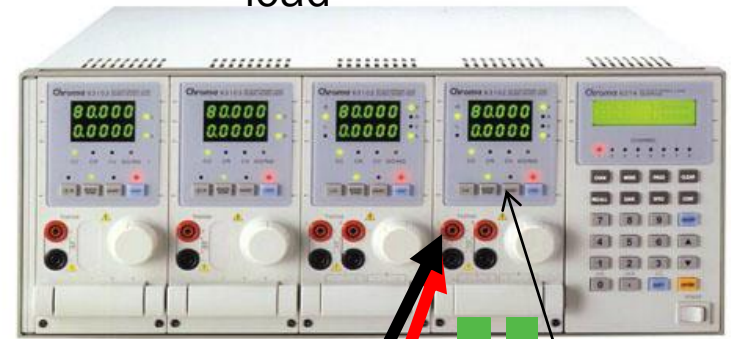

- Press short circuit at $V_{in} = 36\text{ V}$, $I_{out} = 6\text{ A}$. Board enters hiccup and ticks. Press short
- Repeat test for $V_{in} = 57\text{ V}$
- Release short and make sure output resumes at 12 V

Test n°3

source



load

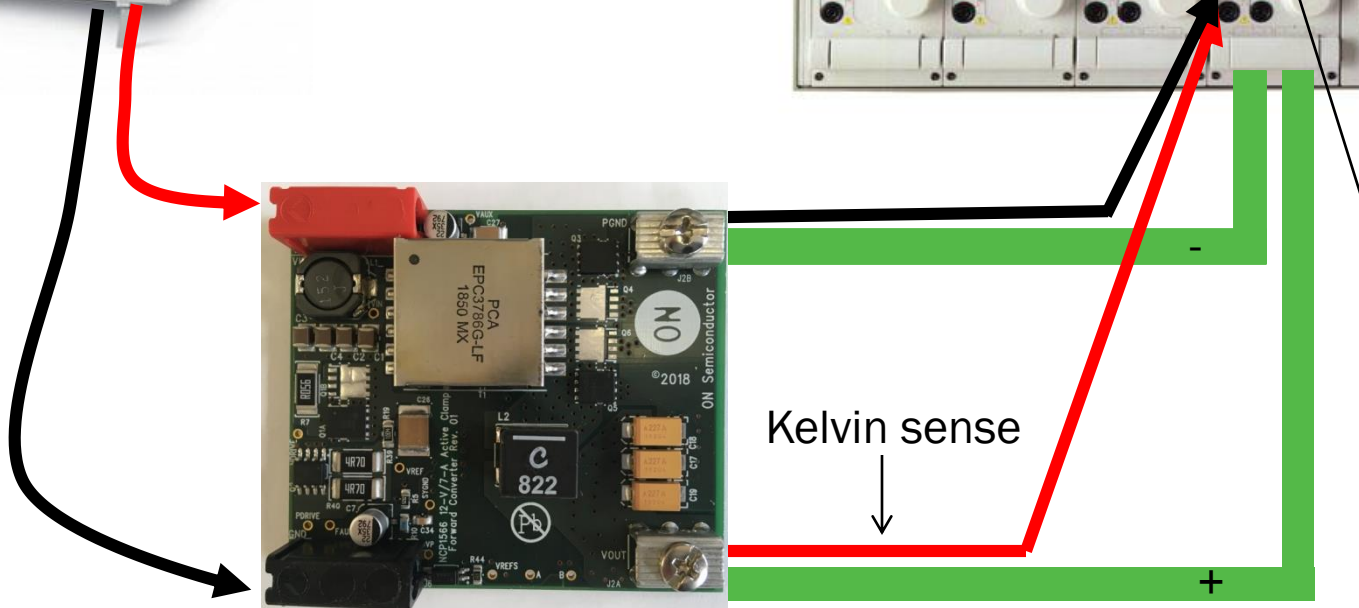
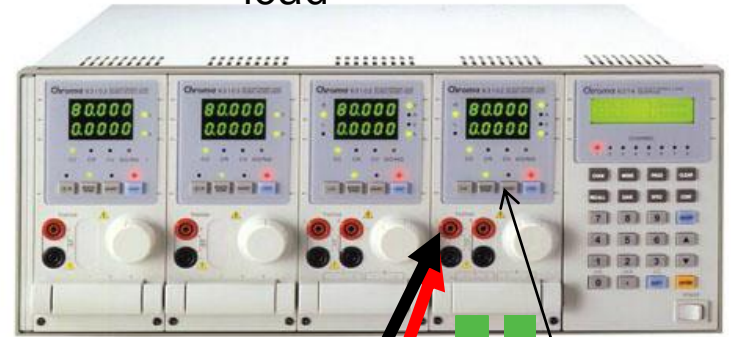

- Program load to dynamic current mode
- I_{out} from 4 A to 6 A, slope 1 A/ μ s
- 1 ms interval, observe V_{out} on scope in ac, 50 mV/div



No pigtail!

Test n°3

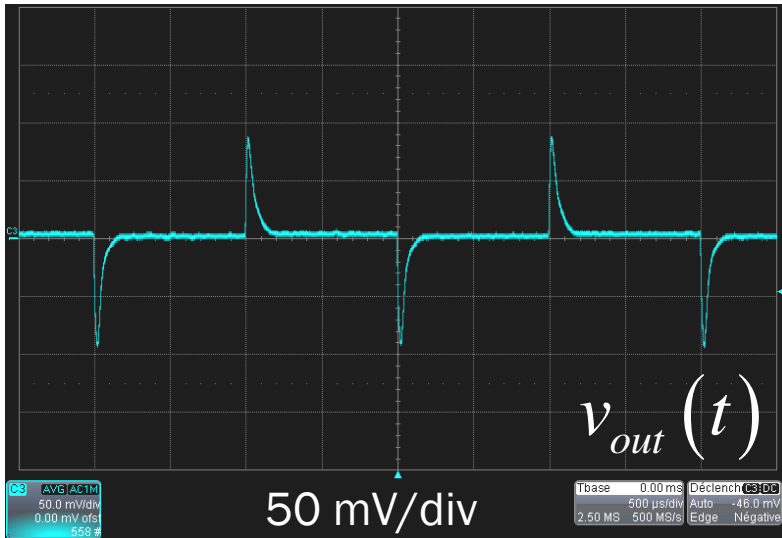

$$V_{in} = 36 \text{ V} - 2 \text{ to } 6 \text{ A} - 1 \text{ A}/\mu\text{s}$$

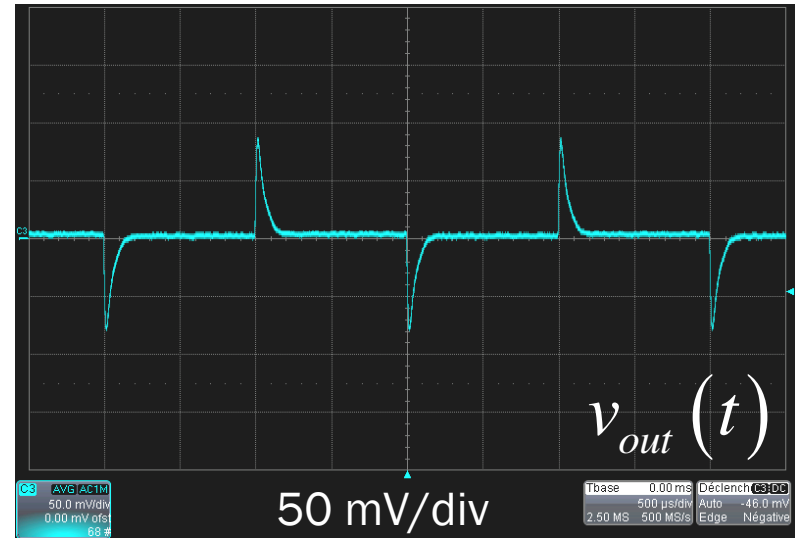

$$V_{in} = 48 \text{ V} - 2 \text{ to } 6 \text{ A} - 1 \text{ A}/\mu\text{s}$$

- Run the test from $V_{in} = 36 \text{ V}$ (worst case) to $V_{in} = 57 \text{ V}$.
- Spec is to have an under/over shoot less than 150 mV

Test n° 4

source



load

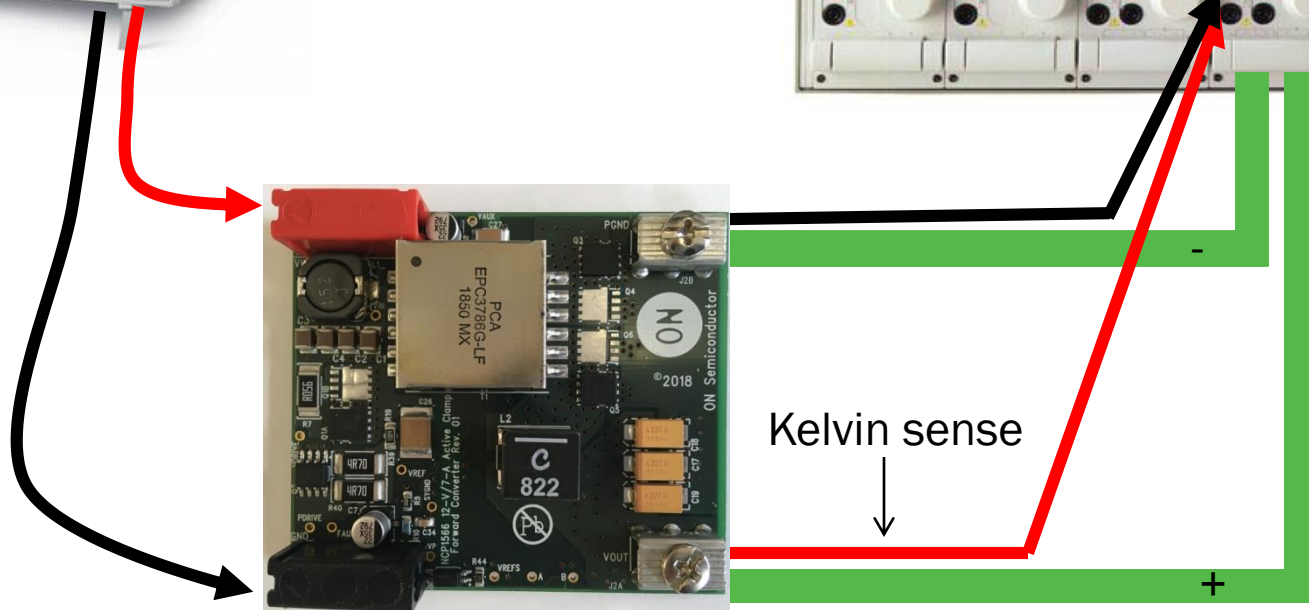
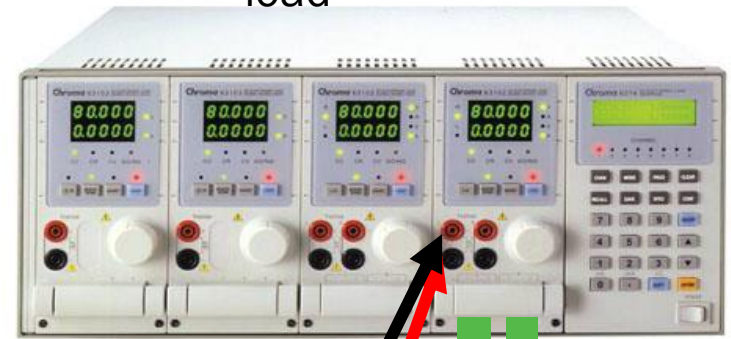

- Leave the board for 5 mn at $V_{in} = 36 \text{ V}/6 \text{ A}$ and room temperature.
- Check no thermal tripping occurs.
- Board is declared sound.