

SUMMARY

Wires



Image is for illustrative purpose only

Series	1S
Termination type	No contacts / Accessory
IP rating	0
AWG wire size	0.00 - 0.00
Cable Ø	0.00 - 0.00 mm
Status	active

Download

[Request a quote](#)

[Catalog](#)

TECHNICAL DETAILS

Mechanics

Shell Style/Model	GRA*: Insulating washer
Keying	No keying
Housing Material	PEEK (Polyetheretherketone) shell and collet nut, nickel plated [SAE AMS QQ N 290] brass latch sleeve and mid pieces
Weight	.13 g

Performance

Configuration
Insulator
Rated Current

Others

Temp (min / max):	-50° C / +90° C
Humidity (max):	<=95% [at 60 deg C / 140 F]
Vibration:	15 g [10 Hz - 2000 Hz]
Shock Resistance:	100 g [6 ms]

LEMO products and services are provided "as is". LEMO makes no warranties or representations with regard to LEMO product & services or use of them, express, implied or statutory, including for accuracy, completeness, or security. The user is fully responsible for his products and applications using LEMO components.

Climatical Category: 50/175/21
Shielding (min): 75 dB (10 MHz)
Shielding (min): 40 dB (1 GHz)

DRAWINGS

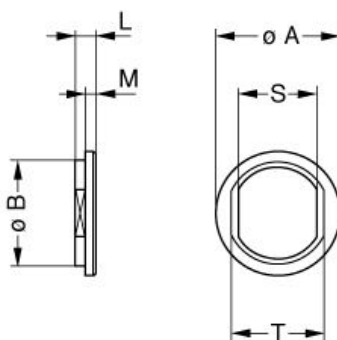

No keying

Dimensions

	A	B	L	M	S	T
mm.	16	13.8	1.8	1	10.6	12.2
in.	0,63	0,54	0,07	0,04	0,42	0,48

RECOMMENDED BY LEMO

Tools

LEMO products and services are provided "as is". LEMO makes no warranties or representations with regard to LEMO product & services or use of them, express, implied or statutory, including for accuracy, completeness, or security. The user is fully responsible for his products and applications using LEMO components.