

## TWL6040 8-Channel Low-Power Audio Codec for Portable Applications

### 1 Device Overview

#### 1.1 Features

- Four Audio Digital-to-Analog Converter (DAC) Channels
- Stereo Capless Headphone Drivers:
  - Up to 104-dB DR
  - Power Tune for Performance and Power Consumption Tradeoff
- Stereo 8  $\Omega$ , 1.5 W per Channel Speaker Drivers
- Differential Earpiece Driver
- Stereo Line-Out
- Two Audio Analog-to-Digital Converter (ADC) Channels:
  - 96-dBA SNR
- Four Audio Inputs:
  - Three Differential Microphone Inputs
  - Stereo Line-In and FM Input
- Two Vibrator and Haptics Feedback Channels:
  - Differential H-Bridge Drivers
- Two Low-Noise Analog Microphone Bias Outputs
- Two Digital Microphone Bias Outputs
- Analog Low-Power Loop from Line-in to Headphone and Speaker Outputs
- Dual Phase-Locked Loops (PLLs) for Flexible Clock Support:
  - 32-kHz Sleep Clock Input for System Low-Power Playback Mode
  - 12-, 19.2-, 26-, and 38.4-MHz System Clock Input
- Accessory Plug and Unplug Detection, Accessory Button Press Detection
- Integrated Power Supplies:
  - Negative Charge Pump for Capless Headphone Driver
  - Two Low Dropout Voltage Regulators (LDOs) for High Power Supply Rejection Ratio (PSRR)
- I<sup>2</sup>C Control
- Thermal Protection:
  - Host Interrupt
- Power Supplies:
  - Analog: 2.1 V
  - Digital I/O: 1.8 V
  - Battery: 2.3 to 5.5 V
- Package 6-mm  $\times$  6-mm 120-Pin PBGA

#### 1.2 Applications

- Mobile and Smart Phones
- MP3 Players
- Handheld Devices

#### 1.3 Description

The TWL6040 device is an audio coder/decoder (codec) with a high level of integration providing analog audio codec functions for portable applications, as shown in [Figure 1-1](#). The device contains multiple audio analog inputs and outputs, as well as microphone biases and accessory detection. The device is connected to the OMAP™ 4 host processor through a proprietary PDM interface for audio data communication enabling partitioning with optimized power consumption and performance. Multichannel audio data is multiplexed to a single wire for downlink (PDML) and uplink (PDMUL).

The OMAP4 device provides the TWL6040 device with five PDM audio-input channels (DL0–DL4). Channels DL0–DL3 are connected to four parallel DAC channels multiplexed to stereo headphone (HSL, HSR), stereo speaker (HFL, HFR), and earpiece (EAR) or stereo line outputs (AUXL, AUXR).

The stereo headphone path has a low-power (LP) mode operating from a 32-kHz sleep clock to enable more than 100 hours of MP3 playback time. Very-high dynamic range of 104 dBA is achieved when using the system clock input and DAC path high-performance (HP) mode. Class-AB headphone drivers provide a 1- $V_{\text{rms}}$  capability output and are ground centered for capless connection to a headphone, thus enabling system size and cost reduction. The earpiece driver is a differential class-AB driver with 2  $V_{\text{rms}}$  capability to a typical 32- $\Omega$  load or 1.4  $V_{\text{rms}}$  to a typical 16- $\Omega$  load.



Stereo speaker path has filterless class-D outputs with 1.5-W capability per channel. Output power maximization supply connections to an external boost is supported. Speaker drivers also support hearing aid coil loads. For vibrator and haptic feedback support, the TWL6040 has two PWM channels with independent input signals from DL4 or inter-integrated circuit (I<sup>2</sup>C).

Vibrator drivers are differential H-bridge outputs, enabling fast acceleration and deceleration of vibrator motor. An external driver for a hearing aid coil or a piezo speaker requiring high voltage can be connected to line outputs.

The TWL6040 supports three differential microphone inputs (MMIC, HMIC, and SMIC) and a stereo line-input (AFML, AFMR) multiplexed to two parallel ADCs. The PDM output from the ADCs is transmitted to the OMAP4 processor through UL0 and UL1. AFML, AFMR inputs can also be looped to analog outputs (LB0, LB1).

Two LDOs provide a voltage of 2.1 V to bias analog microphones (MBIAS and HBIAS). The maximum output current is 2 mA for each analog bias, allowing up to two microphones on one bias. Two LDOs provide a voltage of 1.8 V/1.85 V to bias digital microphones (DBIAS1 and DBIAS2). One bias generator can bias several digital microphones at the same time, with a total maximum output current of 10 mA.

The TWL6040 has an integrated negative charge pump (NCP) and two LDOs (HS LDO and LS LDO) for high PSRR. The only external supply needed is 2.1 V, which is available from the 2.1-V DC-DC of the TWL6030 power-management IC (PMIC) in the OMAP4 system. By powering audio from low-noise 2.1-V DC-DC of low power consumption, high dynamic range and high output swing at headset output are achieved. All other supply inputs can be directly connected to battery or system 1.8-V I/O.

Two integrated PLLs enable operation from a 12-, 19.2-, 26-, and 38.4-MHz system clock (MCLK) or, in LP playback mode, from a 32-kHz sleep clock (CLK32K). The frequency plan is based on a 48-kS/s audio data rate for all channels, and host processor uses sample-rate converters to interface with different sample rates (for example, 44.1 kHz). In the specific case of low-power audio playback, the TWL6040 supports the 44.1-kS/s and 48-kS/s rates. Transitions between sample rates or input clocks are seamless.

Accessory plug and unplug detections are supported (PLUGDET). Some headsets have a manual switch for submitting send/end signal to the terminal through the microphone input pin. This feature is supported by a periodic accessory button press detection to minimize current consumption in sleep mode. Detection cycle properties can be programmed according to system requirements.

**Table 1-1. Device Information<sup>(1)</sup>**

PART NUMBER	PACKAGE	BODY SIZE (NOM)
TWL6040A2	ZQZ (120)	6.00 mm × 6.00 mm
TWL6040A3	ZQZ (120)	6.00 mm × 6.00 mm

(1) For more information, see [Section 3](#), *Mechanical Packaging and Orderable Information*.

### 1.4 Functional Block Diagram

Figure 1-1 shows the system block diagram of the TWL6040 device.

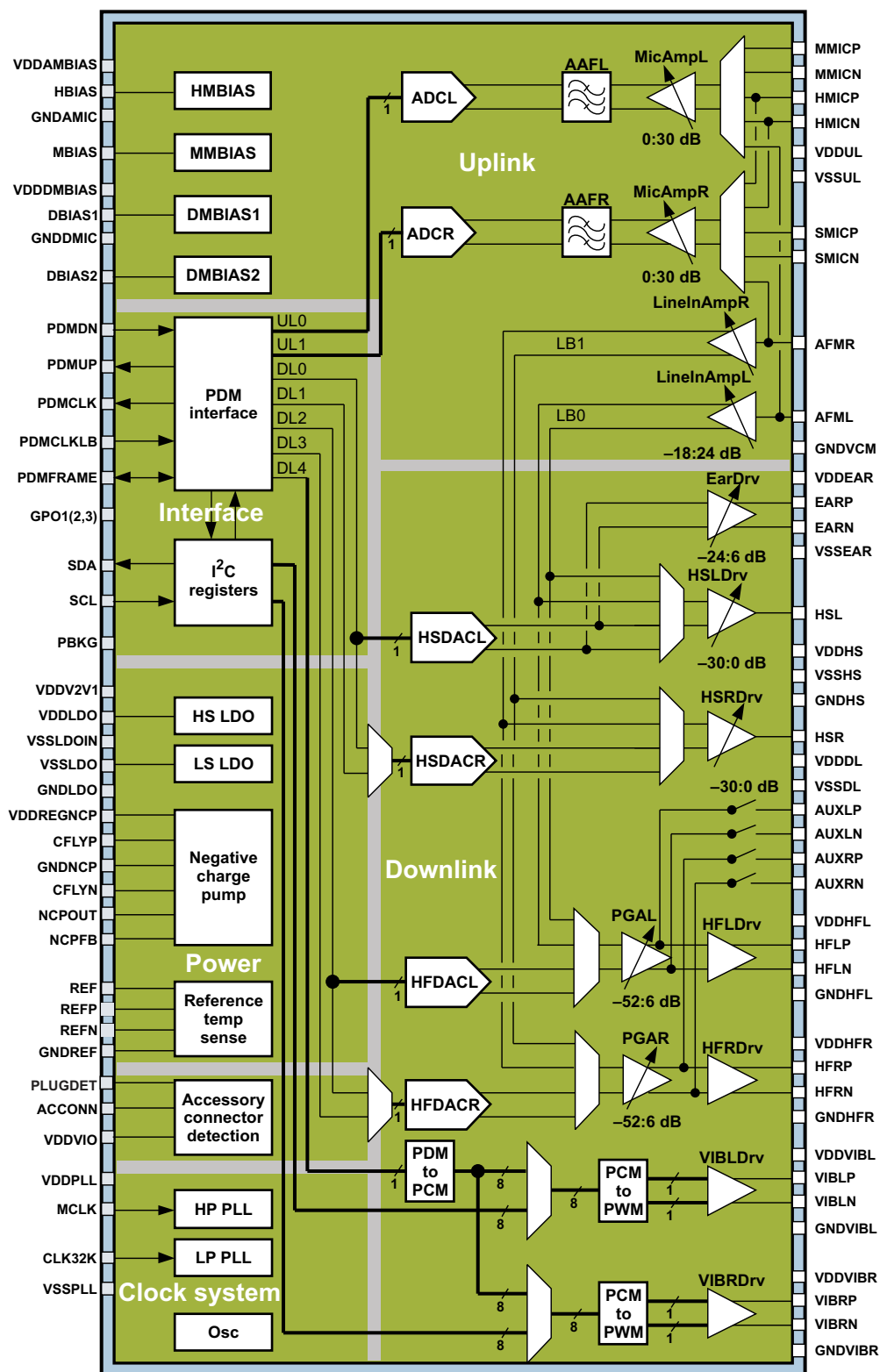

SWCS044-001

Figure 1-1. Simplified Block Diagram

For the complete TWL60xx data sheet (SWCS044), contact your TI sales representative.

**PRODUCT PREVIEW**

## 2 Revision History

NOTE: Page numbers for previous revisions may differ from page numbers in the current version.

---

<b>Changes from Revision A (January 2012) to Revision B</b>	<b>Page</b>
• Changed document to standard TI format .....	<a href="#">1</a>

---

**PRODUCT PREVIEW**

### 3 Mechanical Packaging and Orderable Information

#### 3.1 Packaging Information

The following pages include mechanical packaging and orderable information. This information is the most current data available for the designated devices. This data is subject to change without notice and revision of this document. For browser-based versions of this data sheet, refer to the left-hand navigation.

**PACKAGING INFORMATION**

Orderable Device	Status (1)	Package Type	Package Drawing	Pins	Package Qty	Eco Plan (2)	Lead finish/ Ball material (6)	MSL Peak Temp (3)	Op Temp (°C)	Device Marking (4/5)	Samples
TWL6040A2GZQZR	OBSOLETE	BGA MICROSTAR JUNIOR	ZQZ	120		TBD	Call TI	Call TI		TWL6040A2G	
TWL6040A2ZQZ	OBSOLETE	BGA MICROSTAR JUNIOR	ZQZ	120		TBD	Call TI	Call TI		TWL6040A2	
TWL6040A2ZQZR	OBSOLETE	BGA MICROSTAR JUNIOR	ZQZ	120		TBD	Call TI	Call TI		TWL6040A2	
TWL6040A3SRSZQZR	OBSOLETE	BGA MICROSTAR JUNIOR	ZQZ	120		TBD	Call TI	Call TI		TWL6040A3	
TWL6040A3ZBHR	ACTIVE	NFBGA	ZBH	120	2500	RoHS & Green	SNAGCU	Level-3-260C-168 HR	-40 to 85	6040A3ZBH	Samples
TWL6040A3ZQZ	OBSOLETE	BGA MICROSTAR JUNIOR	ZQZ	120		TBD	Call TI	Call TI		TWL6040A3	

(1) The marketing status values are defined as follows:

**ACTIVE:** Product device recommended for new designs.

**LIFEBUY:** TI has announced that the device will be discontinued, and a lifetime-buy period is in effect.

**NRND:** Not recommended for new designs. Device is in production to support existing customers, but TI does not recommend using this part in a new design.

**PREVIEW:** Device has been announced but is not in production. Samples may or may not be available.

**OBSOLETE:** TI has discontinued the production of the device.

(2) **RoHS:** TI defines "RoHS" to mean semiconductor products that are compliant with the current EU RoHS requirements for all 10 RoHS substances, including the requirement that RoHS substance do not exceed 0.1% by weight in homogeneous materials. Where designed to be soldered at high temperatures, "RoHS" products are suitable for use in specified lead-free processes. TI may reference these types of products as "Pb-Free".

**RoHS Exempt:** TI defines "RoHS Exempt" to mean products that contain lead but are compliant with EU RoHS pursuant to a specific EU RoHS exemption.

**Green:** TI defines "Green" to mean the content of Chlorine (Cl) and Bromine (Br) based flame retardants meet JS709B low halogen requirements of <=1000ppm threshold. Antimony trioxide based flame retardants must also meet the <=1000ppm threshold requirement.

(3) MSL, Peak Temp. - The Moisture Sensitivity Level rating according to the JEDEC industry standard classifications, and peak solder temperature.

(4) There may be additional marking, which relates to the logo, the lot trace code information, or the environmental category on the device.

<sup>(5)</sup> Multiple Device Markings will be inside parentheses. Only one Device Marking contained in parentheses and separated by a "~" will appear on a device. If a line is indented then it is a continuation of the previous line and the two combined represent the entire Device Marking for that device.

<sup>(6)</sup> Lead finish/Ball material - Orderable Devices may have multiple material finish options. Finish options are separated by a vertical ruled line. Lead finish/Ball material values may wrap to two lines if the finish value exceeds the maximum column width.

**Important Information and Disclaimer:**The information provided on this page represents TI's knowledge and belief as of the date that it is provided. TI bases its knowledge and belief on information provided by third parties, and makes no representation or warranty as to the accuracy of such information. Efforts are underway to better integrate information from third parties. TI has taken and continues to take reasonable steps to provide representative and accurate information but may not have conducted destructive testing or chemical analysis on incoming materials and chemicals. TI and TI suppliers consider certain information to be proprietary, and thus CAS numbers and other limited information may not be available for release.

In no event shall TI's liability arising out of such information exceed the total purchase price of the TI part(s) at issue in this document sold by TI to Customer on an annual basis.

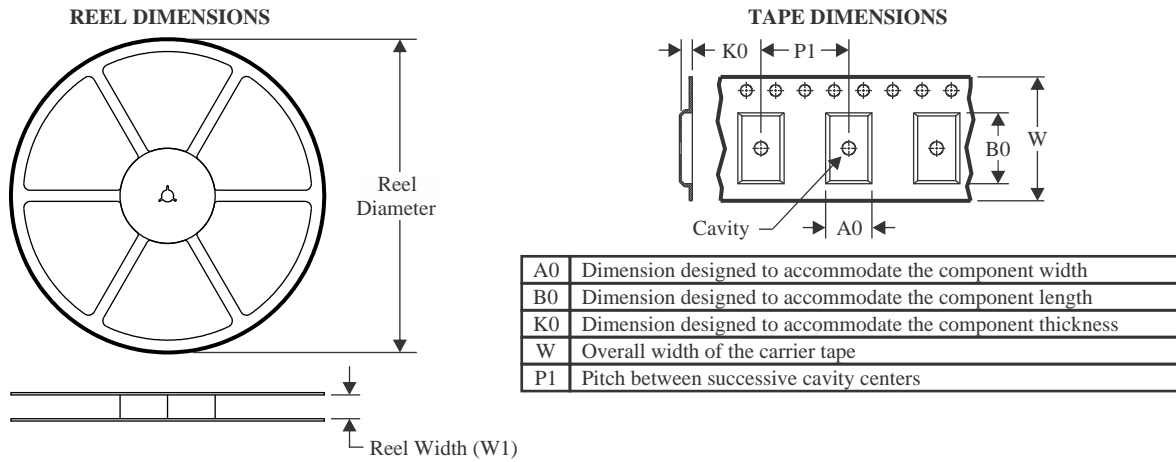

**TAPE AND REEL INFORMATION**

**QUADRANT ASSIGNMENTS FOR PIN 1 ORIENTATION IN TAPE**



\*All dimensions are nominal

Device	Package Type	Package Drawing	Pins	SPQ	Reel Diameter (mm)	Reel Width W1 (mm)	A0 (mm)	B0 (mm)	K0 (mm)	P1 (mm)	W (mm)	Pin1 Quadrant
TWL6040A3ZBHR	NFBGA	ZBH	120	2500	330.0	16.4	6.3	6.3	2.1	8.0	16.0	Q1

**TAPE AND REEL BOX DIMENSIONS**

\*All dimensions are nominal

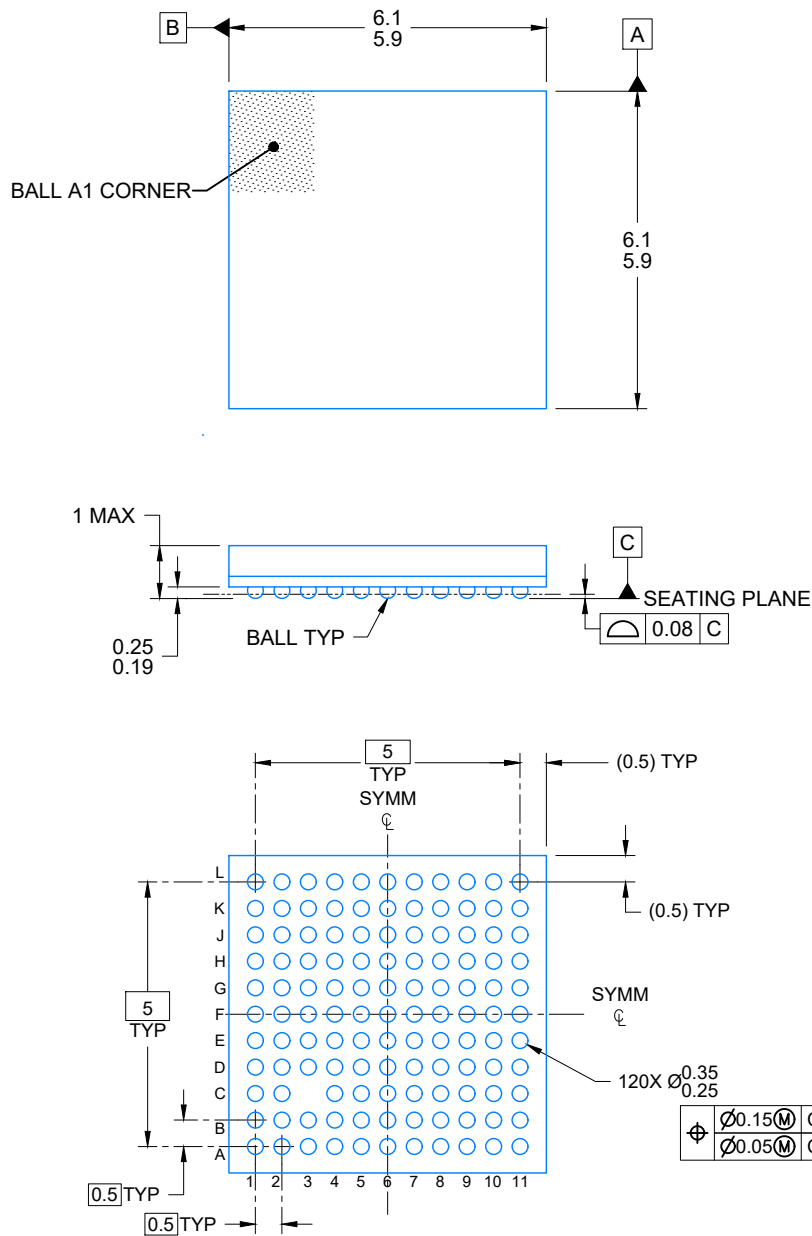
Device	Package Type	Package Drawing	Pins	SPQ	Length (mm)	Width (mm)	Height (mm)
TWL6040A3ZBHR	NFBGA	ZBH	120	2500	336.6	336.6	31.8



4225681/A 02/2020

NOTES:

NanoFree is a trademark of Texas Instruments.

1. All linear dimensions are in millimeters. Any dimensions in parenthesis are for reference only. Dimensioning and tolerancing per ASME Y14.5M.
2. This drawing is subject to change without notice.

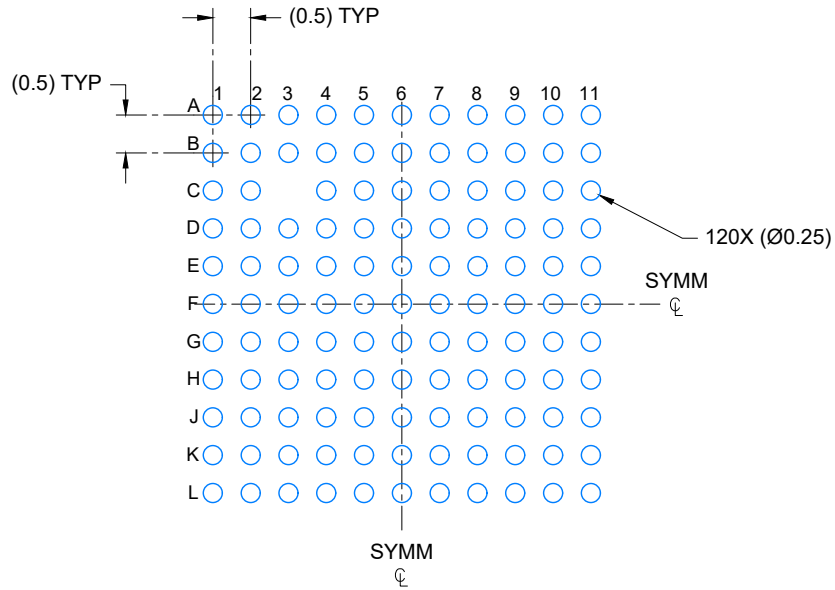

LAND PATTERN EXAMPLE  
SCALE: 10X

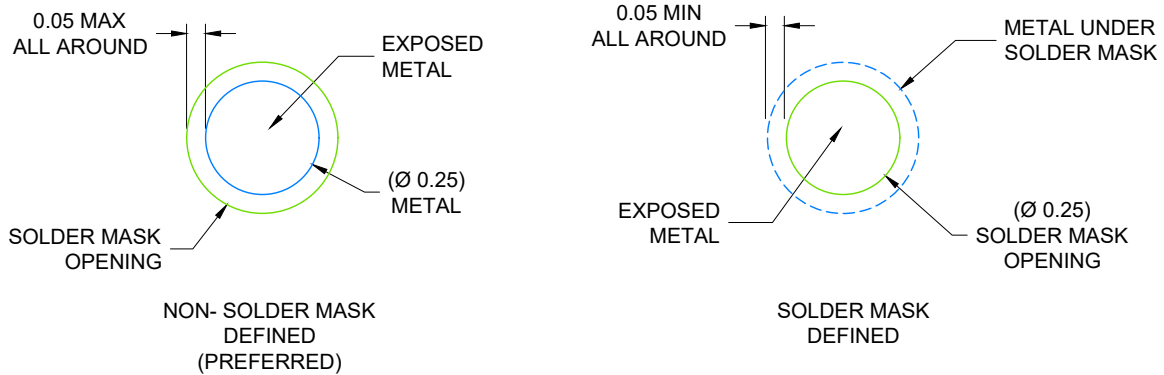

SOLDER MASK DETAILS  
NOT TO SCALE

4225681/A 02/2020

NOTES: (continued)

- Final dimensions may vary due to manufacturing tolerance considerations and also routing constraints. Refer to Texas Instruments Literature number SNVA009 ([www.ti.com/lit/snva009](http://www.ti.com/lit/snva009)).

# EXAMPLE STENCIL DESIGN

ZBH0120A

NFBGA - 1 mm max height

PLASTIC BALL GRID ARRAY

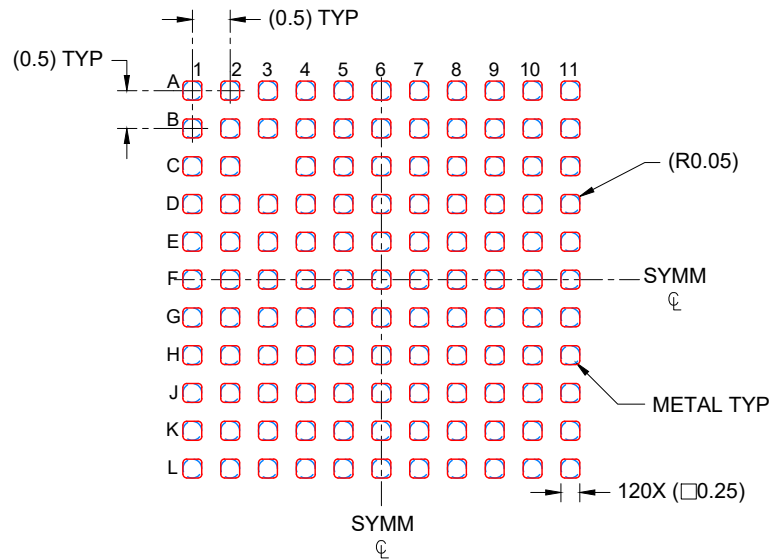

SOLDER PASTE EXAMPLE  
BASED ON 0.100 mm THICK STENCIL  
SCALE: 10X

4225681/A 02/2020

NOTES: (continued)

4. Laser cutting apertures with trapezoidal walls and rounded corners may offer better paste release.

ZQZ (S-PBGA-N120)

PLASTIC BALL GRID ARRAY

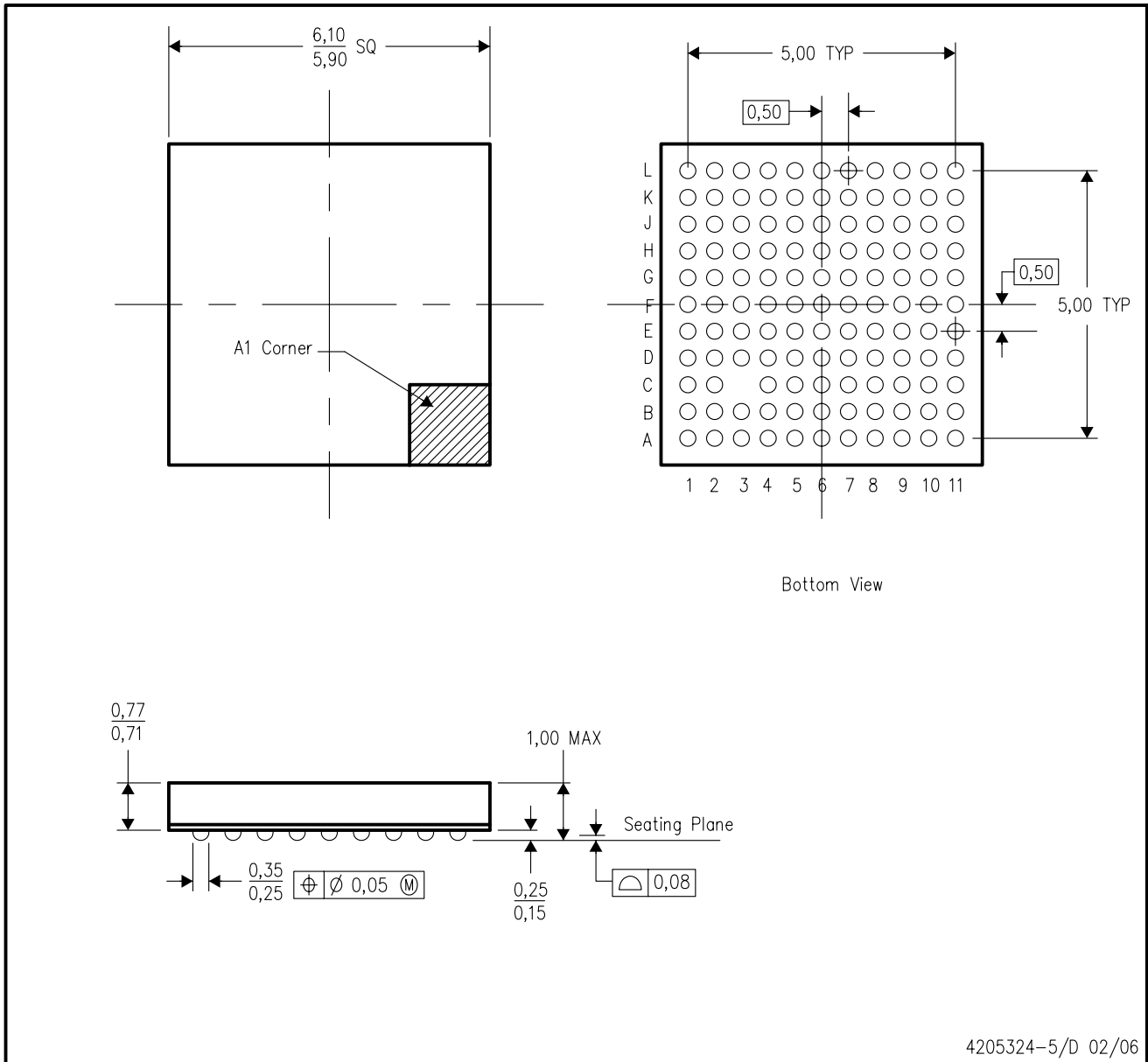

- NOTES:
- A. All linear dimensions are in millimeters.
  - B. This drawing is subject to change without notice.
  - C. Falls within JEDEC MO-225
  - D. This package is lead-free.

## IMPORTANT NOTICE AND DISCLAIMER

TI PROVIDES TECHNICAL AND RELIABILITY DATA (INCLUDING DATA SHEETS), DESIGN RESOURCES (INCLUDING REFERENCE DESIGNS), APPLICATION OR OTHER DESIGN ADVICE, WEB TOOLS, SAFETY INFORMATION, AND OTHER RESOURCES "AS IS" AND WITH ALL FAULTS, AND DISCLAIMS ALL WARRANTIES, EXPRESS AND IMPLIED, INCLUDING WITHOUT LIMITATION ANY IMPLIED WARRANTIES OF MERCHANTABILITY, FITNESS FOR A PARTICULAR PURPOSE OR NON-INFRINGEMENT OF THIRD PARTY INTELLECTUAL PROPERTY RIGHTS.

These resources are intended for skilled developers designing with TI products. You are solely responsible for (1) selecting the appropriate TI products for your application, (2) designing, validating and testing your application, and (3) ensuring your application meets applicable standards, and any other safety, security, regulatory or other requirements.

These resources are subject to change without notice. TI grants you permission to use these resources only for development of an application that uses the TI products described in the resource. Other reproduction and display of these resources is prohibited. No license is granted to any other TI intellectual property right or to any third party intellectual property right. TI disclaims responsibility for, and you will fully indemnify TI and its representatives against, any claims, damages, costs, losses, and liabilities arising out of your use of these resources.

TI's products are provided subject to [TI's Terms of Sale](#) or other applicable terms available either on [ti.com](https://www.ti.com) or provided in conjunction with such TI products. TI's provision of these resources does not expand or otherwise alter TI's applicable warranties or warranty disclaimers for TI products.

TI objects to and rejects any additional or different terms you may have proposed.

Mailing Address: Texas Instruments, Post Office Box 655303, Dallas, Texas 75265  
Copyright © 2023, Texas Instruments Incorporated