

Regulations  
No.

KG3F6582/K

Total pages

Page

14

1

# Product Specification

**High Bright Surface Mounting PLCC4 LED**

**Type Number : LNJ8L4C28RAA**

**Panasonic Unified Parts Number : LNJ8L4C28RAA**

## Semiconductor Company, Panasonic Corporation

Established by	Applied by	Checked by	Prepared by
<i>K. Takesako</i>	K.Takesako	T.Kitazono	A.Nakano

2010-09-29

Established

Revised

	Product Specification	LNJ8L4C28RAA	
		Total pages	Page
		14	2

Table of contents

1. Product Summary .....	3
2. Absolute Maximum Ratings .....	3
3. Electrical-Optical Characteristics .....	3 ~ 7
4. Outline .....	8
5. Recommended Land Layout .....	8
6. Recommended Soldering Conditions .....	9 ~ 10
7. Precautions for Application Design .....	11
8. Handling Instructions .....	12 ~ 13
9. Thermal Stress to Optical Device .....	14
10. Guarantee .....	14
11. Others .....	14

《Attached paper》

1. Packing Specification .....	1 ~ 5
2. Reliability Test Result .....	1

2010-09-29		
Established	Revised	

<h1>Product Specification</h1>		<b>LNJ8L4C28RAA</b>	
		Total pages	Page
		14	3

## ■ Product Summary

Type	Red Light Emitting Diode (3528 Package size Type Chip LED)
Application	Automotive
Material	AllnGaP

## ■ Absolute Maximum Ratings

Item	Symbol	Ratings	Unit	Remarks
Power dissipation	$P_D$	190	mW	
Forward current	$I_F$	70	mA	
Pulse forward current (Note1)	$I_{FP}$	100	mA	
Reverse voltage	$V_R$	5	V	
Junction temperature	$T_j$	125	°C	
Thermal resistance	$R_{th}$	130	°C/W	
Operating ambient temperature	$T_{opr}$	-40 ~ +105	°C	
Storage temperature	$T_{stg}$	-40 ~ +125	°C	

(Note1) The condition of  $I_{FP}$  is duty 10 %, pulse width 1 ms  
Please contact us for further information regarding special operating conditions such as  
 $I_F$ : less than DC =3 mA  
 $I_{FP}$ : less than pulse width =1 ms, duty=10 %

## ■ Electrical-Optical Characteristics (Ta=25 °C±3 °C)

Item	Symbol	Condition	Min.	Typ.	Max.	Unit
Luminous intensity (Note2)	$I_o$	$I_F=50$ mA DC	1 450	1 810	2 260	mcd
Reverse current	$I_R$	$V_R=5$ V	—	—	10	$\mu$ A
Forward voltage (Note3)	$V_F$	$I_F=50$ mA DC	2.05	2.30	2.65	V
Luminous Flux (Note2)	F	$I_F=50$ mA DC	(5.40)	(6.72)	(8.40)	lm
Dominant emission wavelength (Note4)	$\lambda_d$	$I_F=50$ mA DC	612	617	624	nm
Peak emission wavelength	$\lambda_p$	$I_F=50$ mA DC	—	623	—	nm
Spectral line half width	$\Delta\lambda$	$I_F=50$ mA DC	—	20	—	nm

(Note2) Rank classification of luminous intensity and luminous flux.

Rank	Luminous intensity	Unit	Luminous flux	Unit
31	1 450 ~ 1 630	mcd	(5.40) ~ (6.06)	lm
32	1 630 ~ 1 810		(6.06) ~ (6.72)	
41	1 810 ~ 2 035		(6.72) ~ (7.56)	
42	2 035 ~ 2 260		(7.56) ~ (8.40)	

- Measurement tolerance is  $\pm 11$  %.
- Luminous intensity standard is equal to NIST.

2010-09-29		
Established	Revised	

(Note3) Rank classification of forward voltage. (Condition:  $I_F=50$  mA DC)

Rank	Forward Voltage	Unit
R	2.05 ~ 2.20	V
S	2.20 ~ 2.35	
T	2.35 ~ 2.50	
U	2.50 ~ 2.65	

· Measurement tolerance is  $\pm 0.15$  V.

(Note4) Rank classification of dominant emission wavelength. (Condition:  $I_F=50$  mA DC)

Rank	Dominant emission wavelength	Unit
A	612 ~ 616	nm
B	616 ~ 620	
C	620 ~ 624	

· Measurement tolerance is  $\pm 2$  nm.

(Note5) Be careful about the product destruction by static electricity.

(Note6) Precautions for circuit design of LED operation.

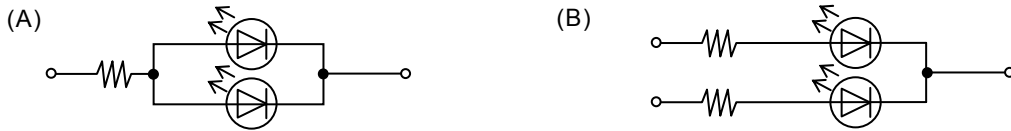

The brightness difference is thought by the influence of VF about the circuit of (A) and avoids using, please.

Recommend the use of the circuit of (B).

(Note7) Indication of rank

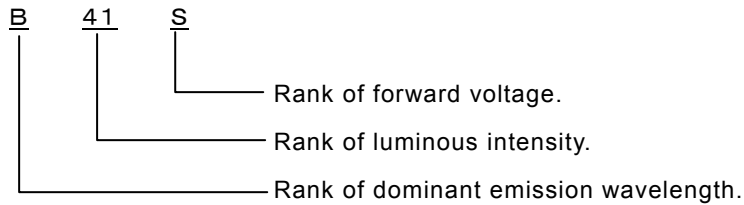

2010-09-29		
Established	Revised	

# Product Specification

LNJ8L4C28RAA

Total pages

Page

14

5

Forward Current vs. Forward Voltage

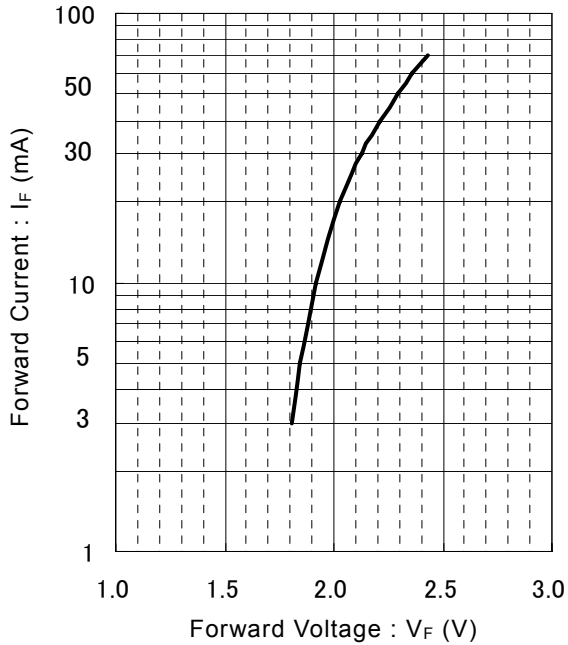

Relative Luminous Intensity vs. Ambient Temperature

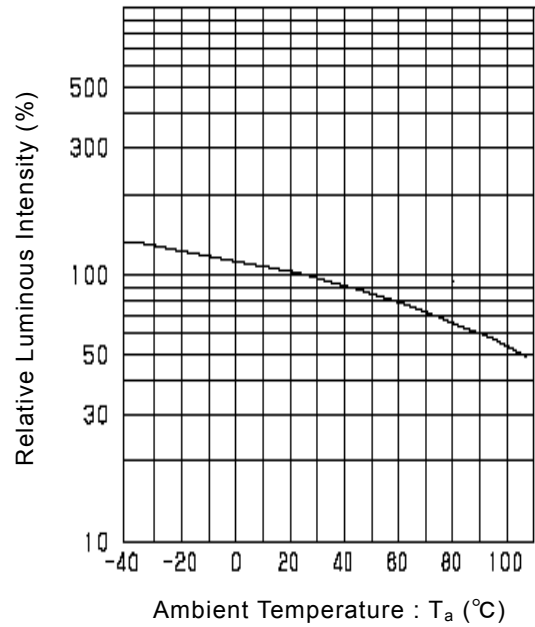

Luminous Intensity vs. Forward Current

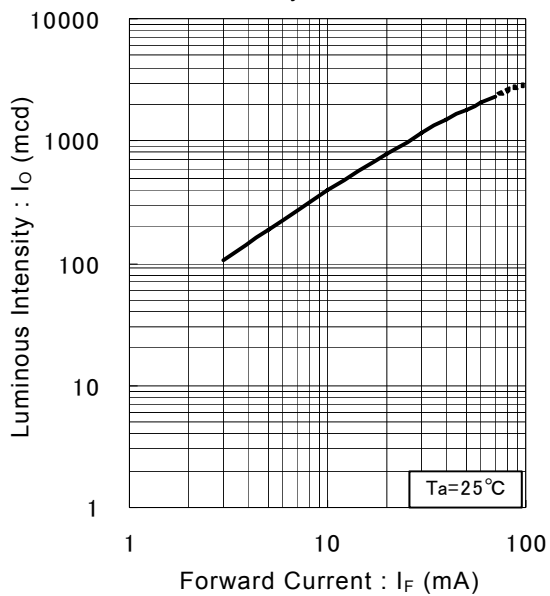

Forward Current vs. Ambient Temperature

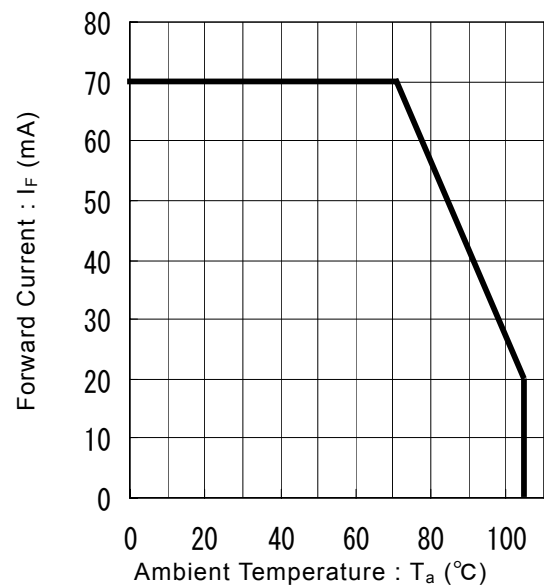

2010-09-29

Established

Revised

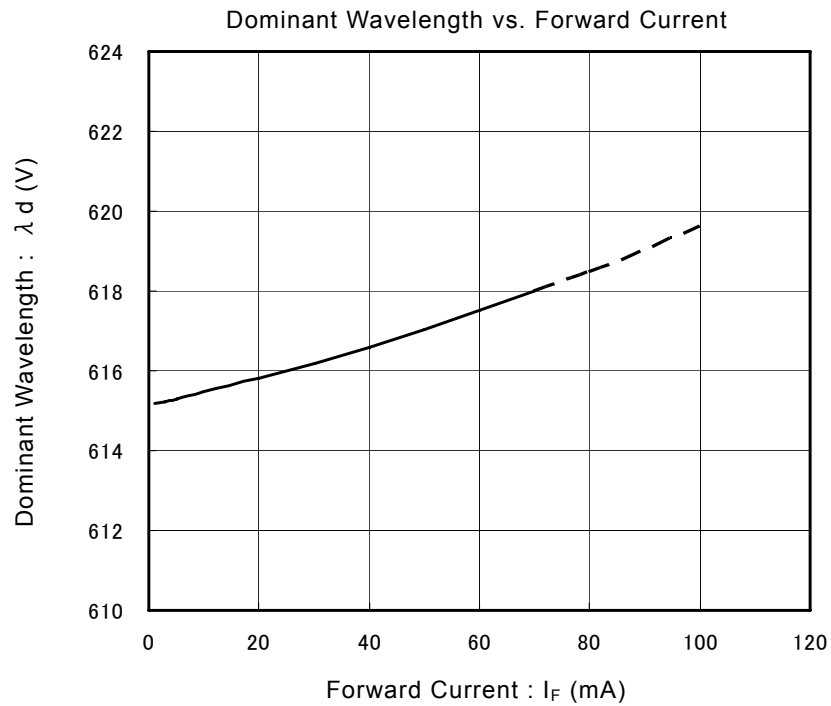
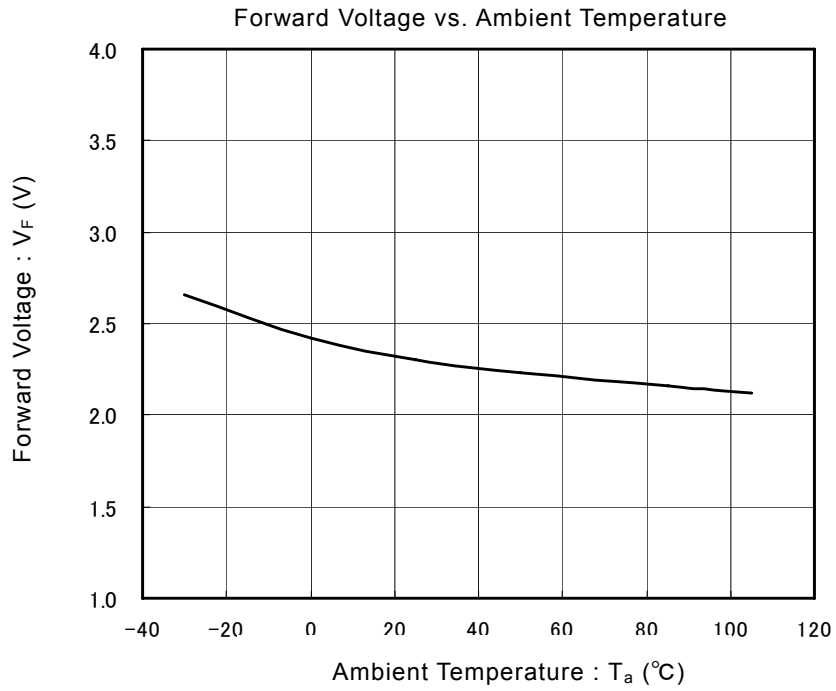

2010-09-29		
Established	Revised	

	<h1>Product Specification</h1>	<b>LNJ8L4C28RAA</b>	
		Total pages	Page
		14	7

Relative Luminous Intensity — Wavelength Characteristics

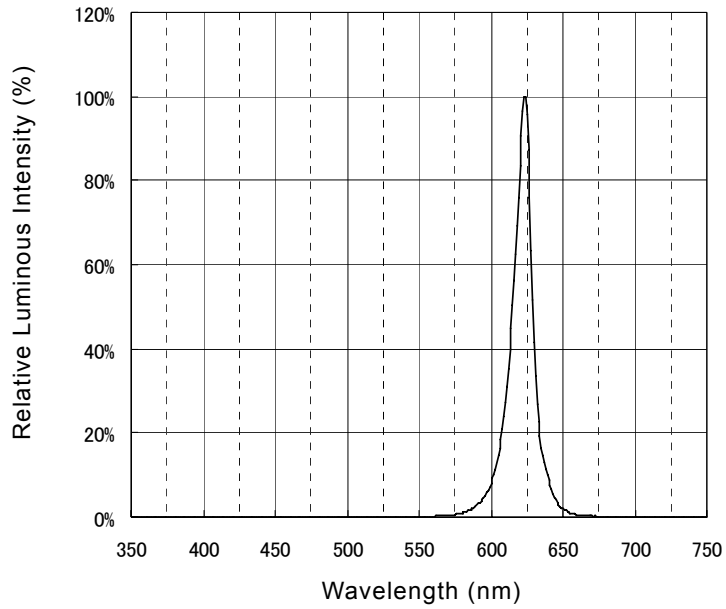

Directive Characteristics

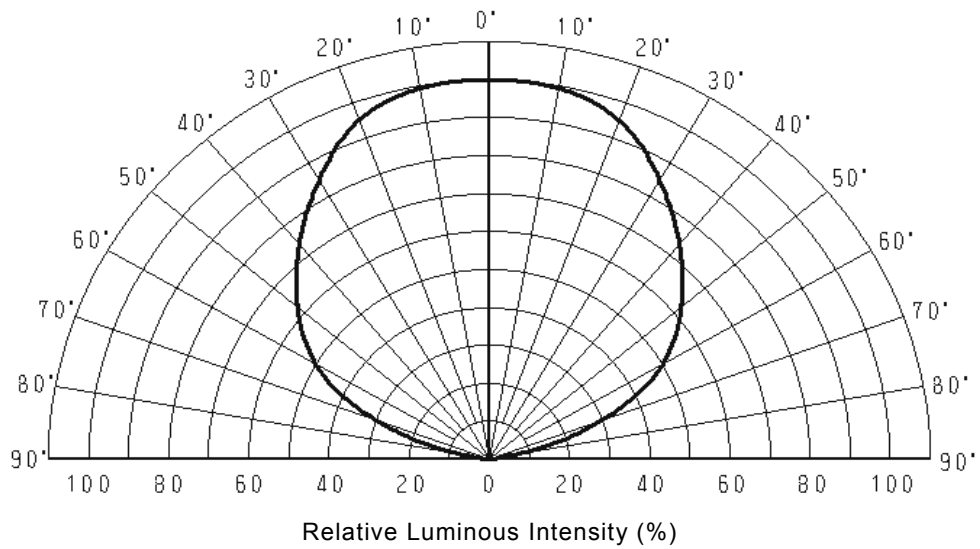

2010-09-29		
Established	Revised	

■ Outline



Unit:mm

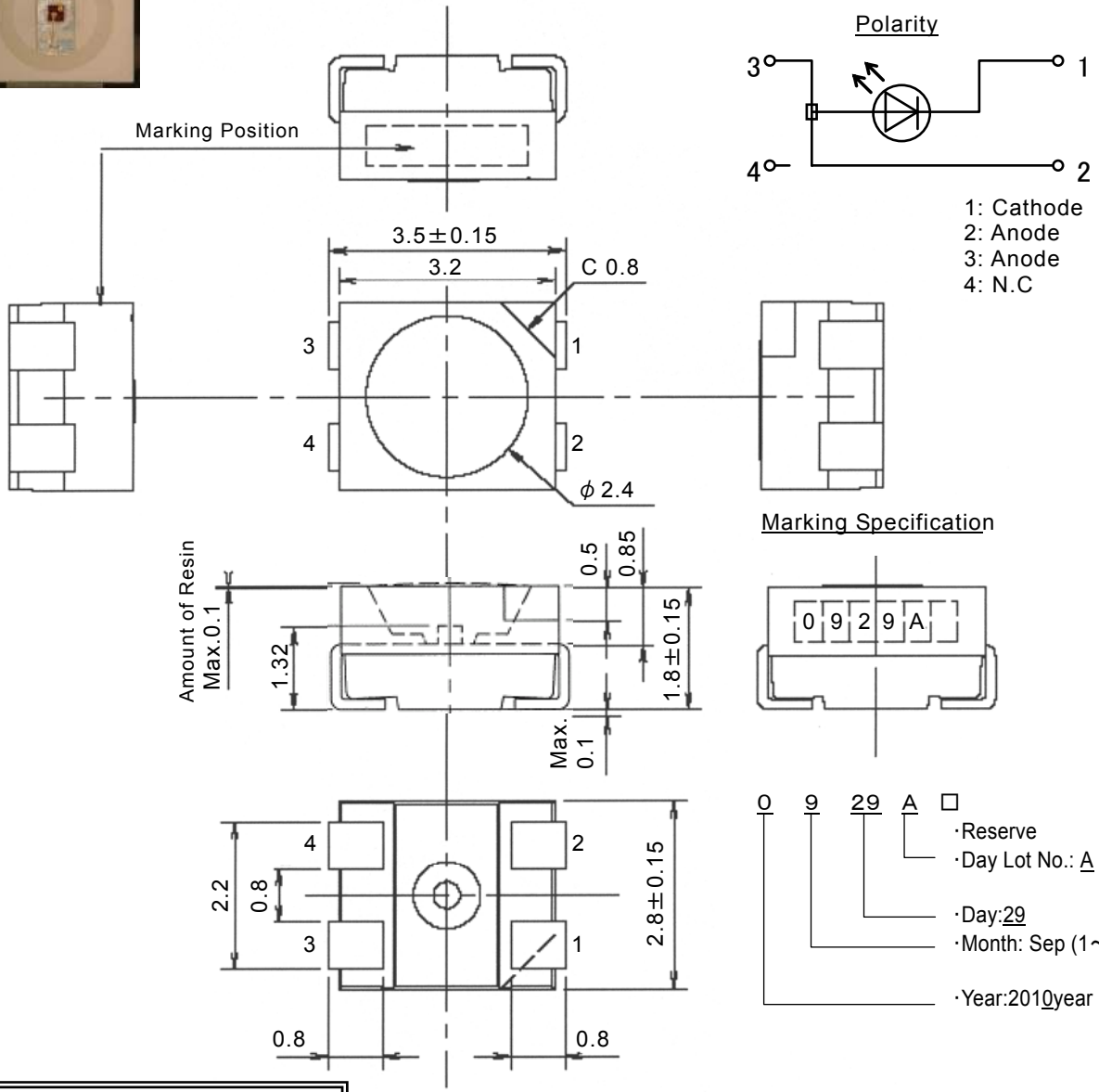

Recommended Land Layout

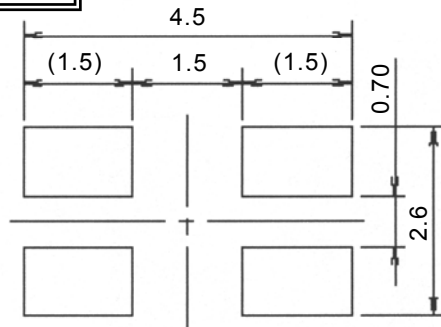

(Note1) Tolerance unless specified: ±0.1 mm.  
(Note2) ( ) A size is a reference.

2010-09-29		
Established	Revised	



Product Specification		LNJ8L4C28RAA	
		Total pages	Page
		14	9

■ Recommended Soldering Conditions

1. The reflow soldering

1) The first time reflow soldering

Please use it on condition that the following.

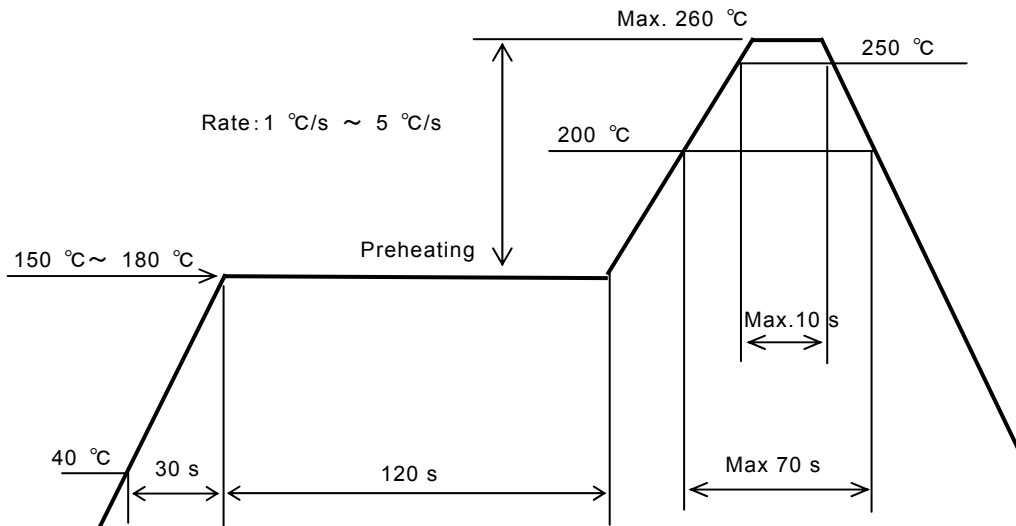

\* This should be a profile on the print wiring board and FPC surface.

2) The second time reflow soldering (Up to the 2nd time)

In case of the second time reflow, please store the product 10 °C ~ 30 °C, 60 %RH and proceed the reflow soldering within 3 days after the first time reflow.

Follow the same condition as the first reflow.

2. Hand soldering

1) Basically keep the temperature on the edge of iron at 350 °C and apply within 3 s.

If the temperature is higher than the condition above, apply in a shorter time (1 s per 10 °C).

2) The iron equipped with temperature control circuit should be used.

3) Do not give a stress to lead or resin on soldering.

Especially do not let iron contact with them.

A LED chip will be damaged and broken by extreme stress.

4) Do not also give a stress to the device and bend of PWBs adjusted right after manual soldering iron.

5) The LED which was removed from PWBs should not be used again.

6) Please do not solder excluding the reflow soldering or the manual soldering iron.

2010-09-29		
Established	Revised	

	<h1>Product Specification</h1>	<b>LNJ8L4C28RAA</b>	
		Total pages	Page
		14	10

### 3. Automatic Mounting

These products are available for automatic mounting machines.

However, concerning demand on structure and performance of these devices, you should pay attentions to the followings below.

- 1) Though we've performed anti-static operation on these devices, static electricity can be frequently occurred in dry atmosphere and cause products to stick on the cover tapes. Please study to control humidity and to perform anti-static measure.
- 2) If a successful mounting is not secured on your systems, you may study the following subjects.
- 3) This product may have damage on the reliability by the mechanical stress on its silicon encapsulation material. Therefore, it is strongly suggested not to contact the resin area and to use the nozzle capable of picking the product by the outline case, as specified below.

Inside diameter of tool	Especially for a round shaped tool, please choose the one not sticking out from the LED's lens area.
Shape of tool	For a particular tool ("asterisk" type etc.), which intends to incline due to its shape. Please study the location and the size of it.
Height of tool	Please set the height of the tool a little lower from top of the face of tape guide.
Position in absorption	Please adjust the absorb position as a center of device as possible.
Vibration in mounting	To reduce the vibration on mounting, please discuss taking necessary measures against optimization of mounting speed and tensions in winding and feeding tapes.
Pin push up system	Mind the pin position of the products prepared a pin-hole (by $\phi 0.5$ mm) on the bottom of the embossed tape. "Pin push up system" is suitable only for products with a pin-hole but not for others.

\* 3528 package recommended nozzle  
 Made by Panasonic factory solutions company "No.1005" type

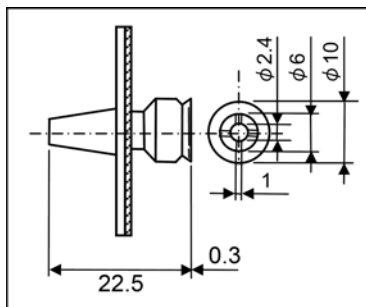

2010-09-29		
Established	Revised	

	Product Specification	LNJ8L4C28RAA	
		Total pages	Page
		14	11

■ Precautions for Application Design

1. Connect the current control resistor in the circuit and operate products within rated range of use.
2. Avoid instant reverse voltage (over current) when turning ON/OFF the circuit.
3. Check a pattern dimension well before use.
4. Avoid using under environments as shown in the following.
  - A place where dust or corrosive gas is generated.
  - A place where dew drop is generated on the product surface (LED).
5. Avoid circuit design that the product (LED) can be heated by adjacent high power electrical heating element such as high power resistor or by high component density.
6. Mount the chip at right angles to the longitudinal direction of the PC board so that the stress on the product should be decreased.

(Notes)

We recommend the LED be placed on the PC board as shown in diagram A.

If the LED must be placed on the PC board as shown in diagram B, special care should be taken to insure that the LED is not affected by bend of the PC board after the soldering process.

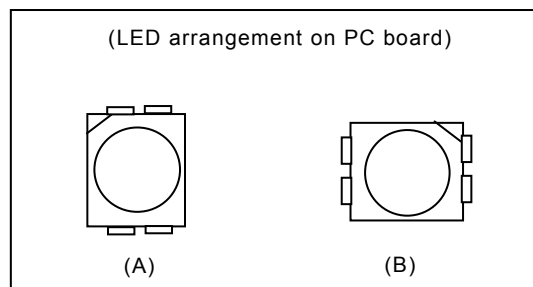

2010-09-29		
Established	Revised	

	<h1>Product Specification</h1>	<b>LNJ8L4C28RAA</b>	
		Total pages	Page
		14	12

■ **Handling Instructions**

1. Storage

In order to avoid absorption of moisture during conveyance and storage of products, we are applying moisture-proof packaging by means of aluminum-laminated bags containing silica gel. Then, when absorption of moisture proceeds, the color of indicators in the silica gel changes, to which must be paid much attention.

After the aluminum-laminated bag is opened, absorption of moisture of the products proceeds quickly, which is likely to cause characteristic defects due to thermal stress generated during the re-flowing process in the worst case.

Therefore when these products are used, be sure to open the bags one by one to complete re-flowing quickly.

LED terminals, as being treated with Ag plating, may be changed in the surface quality and degraded in solderability when exposed to the following conditions.

Therefore, pay enough attention to the storage condition.

2. Conditions and Terms of Storage of Products

Please store products according to the following product conditions depending on the conditions of the products.

Conditions of Product	Conditions of Storage		
	Ambient Temperature	Temperature humidity	Term
When aluminum-laminated bag is not opened yet	10 °C ~ 30 °C	60 % or under	Within one year
When aluminum-laminated bag is opened	10 °C ~ 30 °C	60 % or under	Within 3 days
Up to the second time after the first reflowing	10 °C ~ 30 °C	60 % or under	Within 3 days

If the above-mentioned treatment was not made (including a case of discoloration of the silica gel indicator in the bag or similar), remove moisture by means of baking treatment or the like before use.

《Recommended Baking Conditions》

In a reel condition (as taken out of the aluminum-laminate bag)

Temperature: 60 °C. Time: More than 12 h and up to 24 h.

(However, the baking treatment is limited to one time only.)

(Note)

- The poor characteristic may generate on the products when a great deal of neglect time after the opening in your process.

Also under the products with taping, there is a possibility that the strength of cover tape peeling fluctuates and the mounting error occurs after baking.

Therefore, please take sufficient advance checks and control in your process.

Meanwhile, please note that we are not responsible for the problem occurred except in the condition above.

3. Washing

1) Do not wash the products in principle.

2) If washing is required by a reason of the set, be sure to make it after the products are mounted (after reflowing) according to the following conditions.

- Alcohol is recommended for cleaning.

Do not use a chlorine solvent, which may cause damage to the epoxy and product and deterioration of the products.

- As for ultrasonic cleaning, it may differently affect each of the mounting board, such as resonance. Sufficient checks on the ultrasonic cleaning is required for actual use.

- Avoid the use of brushing because it sometime damages light-emitting surfaces.

2010-09-29		
Established	Revised	

	<h1>Product Specification</h1>	<b>LNJ8L4C28RAA</b>	
		Total pages	Page
		14	13

#### 4. Product strength

Epoxy resin is used as sealing material for light emitting diode on this product.

The molding resin may be peeled off with strong direct shocks in the resin part by reducing strength of the resin after heating.

So you should pay attention to keep products from shocking on resin side, especially during soldering process and using soldering irons.

And after soldering process, please avoid shocking directly on resin side, such as in the following cases, handling PCB's, piling them up and putting them in magazines.

Especially small type chip LEDs should be carefully handled.

#### 5. Static electricity

This LED is sensitive to static electricity and care should be fully taken in handing it.

In the event that the voltage greater than absolute maximum rating is applied, which will damage LEDs.

Please take necessary measures against Static electricity and serge in building LED assembly line and in handling LED in mid-flow of the process.

\* Please take the following measures such that the voltage and surge voltage more than an element resisting pressure level will not be applied.

##### 1) Check the entire drive circuit including the power source.

As a check example, a surge current generated at power-on/off should be checked not to exceed the absolute maximum ratings of the LED.

Please also insert an appropriate protective circuit into the LED driver circuit.

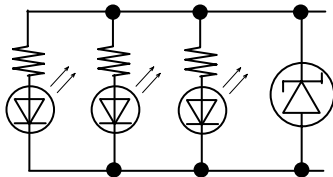

·As shown in the figure, in order to protect LED, it is recommended to use a Zener diode.

##### 2) Beware of destruction by static electricity in handling LEDs.

As proactive measures against static electricity, it is effective to earth your body (via 1 MΩ), spread conductive mat on the floor, wear semi conductive work uniform and shoes and use semi conductive containers.

Also, be sure to earth the nose of a soldering iron.

It is recommended to use an ionizer in the facility or the environment where static electricity may be generated easily.

2010-09-29		
Established	Revised	

	<h1>Product Specification</h1>	<b>LNJ8L4C28RAA</b>	
		Total pages	Page
		14	14

**■ Thermal Stress to Optical Device**

Since light transmissivity is important for the package resin of optical devices (LED's, photodiodes, photo ICs, Photosensors, photocouplers), it is necessary for resin to contain additives in it. For this reason, it has a lower thermal deformation temperature, compared with the package resin for ICs, LSI's and so on and is in the vicinity of the maximum storage temperature. Unless it is designed under the operating conditions, taking into an operating current and ambient conditions into account, the optical devices may be destroyed due to thermal stress caused to the operating optical devices and this may cause lower light output and disconnection.

**■ Guarantee**

The warranty will be valid only within the reliability test results or the items and terms of the reliability assurance standard.

It is also limited to that of the delivered product itself and we are not responsible for the labor cost for replacement work, compensation for loss and the like.

The following cases are onerous since they are out of our guarantee even during the guarantee period:

- Troubles resulting from careless handling or erroneous use.
- Troubles resulting from unreasonable repair or improvement.
- Troubles resulting from irresistible force such as natural disasters.

Should there be any doubt, we will verify it to clarify the cause in the presence of both parties in principle and take a proper action.

**■ Others**

- 1) For matters on quality agreed between you and as those mentioned in these delivery specifications only are valid basically and matters decided between you and us before the receipt of these specifications become invalid unless they are mentioned in these specifications.  
But, if any inadequacy is present, we are ready for a discussion with you to settle the matter.  
In case any modification is required after the receipt of those specifications, only matters agreed by you and us are valid.
- 2) For a special application or question, contact us before the fact and without delay.
- 3) Though we will deliver the products for which we guarantee the matters on quality mentioned in these specifications, please investigate on your side the incorporation into actual sets, duration under actual working conditions and other matters on quality of the products sufficiently.
- 4) If these delivery specifications are not returned to us within two weeks after the issue, we regard them as received, which please understand.
- 5) For the doubts or necessity of change in this specification, mutual discussion will be made for the solution
- 6) The specifications will be changed after prior discussion.
- 7) UL Standard  
UL standard is not acquired since optical characteristics of silicon resin is superior.
- 8) This product is RoHS-free supported.

2010-09-29		
Established	Revised	

<h1 style="margin: 0;">Packing Specification</h1>		LNJ8L4C28RAA	
		Total pages	Page
		5	1

■ Embossed tapping specifications

Unit:mm

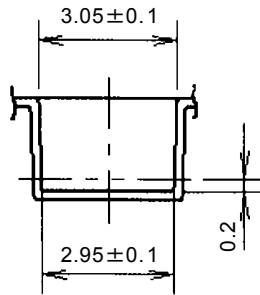
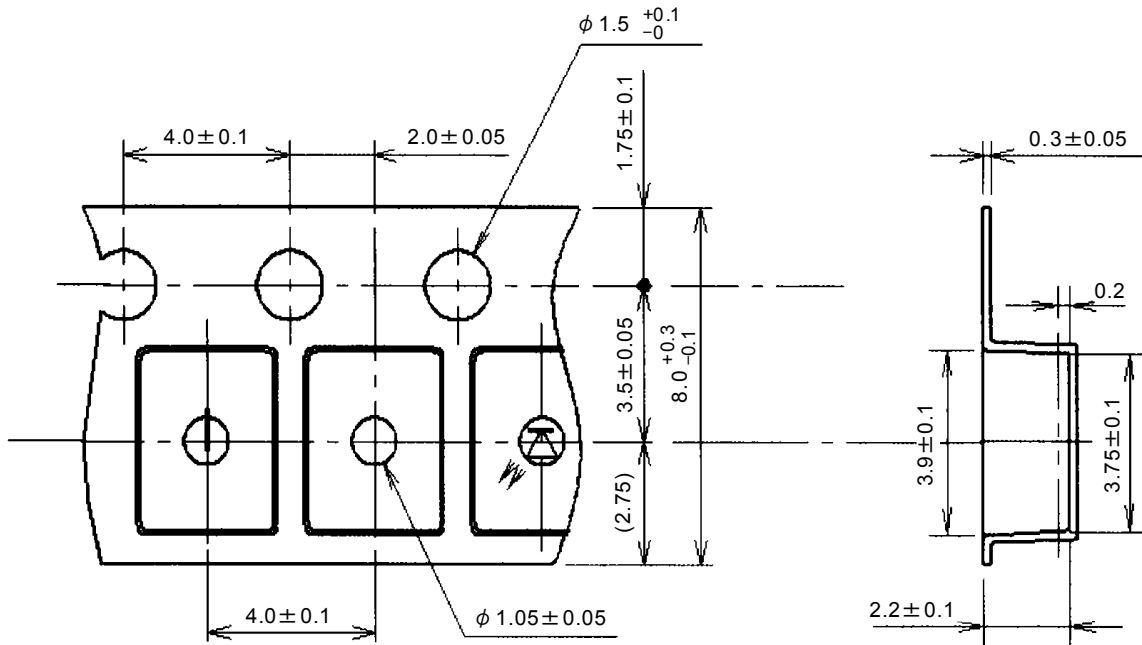

(Note1) Unless specified R of the corner is Max. 0.3 mm.

(Note2) Allowance of accumulated pitch of feeding holes is  $\pm 0.2$  mm per 10 pitches.

(Note3) Tolerance unless specified is  $\pm 0.1$  mm.

2010-09-29		
Established	Revised	

	Packing Specification	LNJ8L4C28RAA	
		Total pages	Page
		5	2

■ Reel Specification

Unit:mm

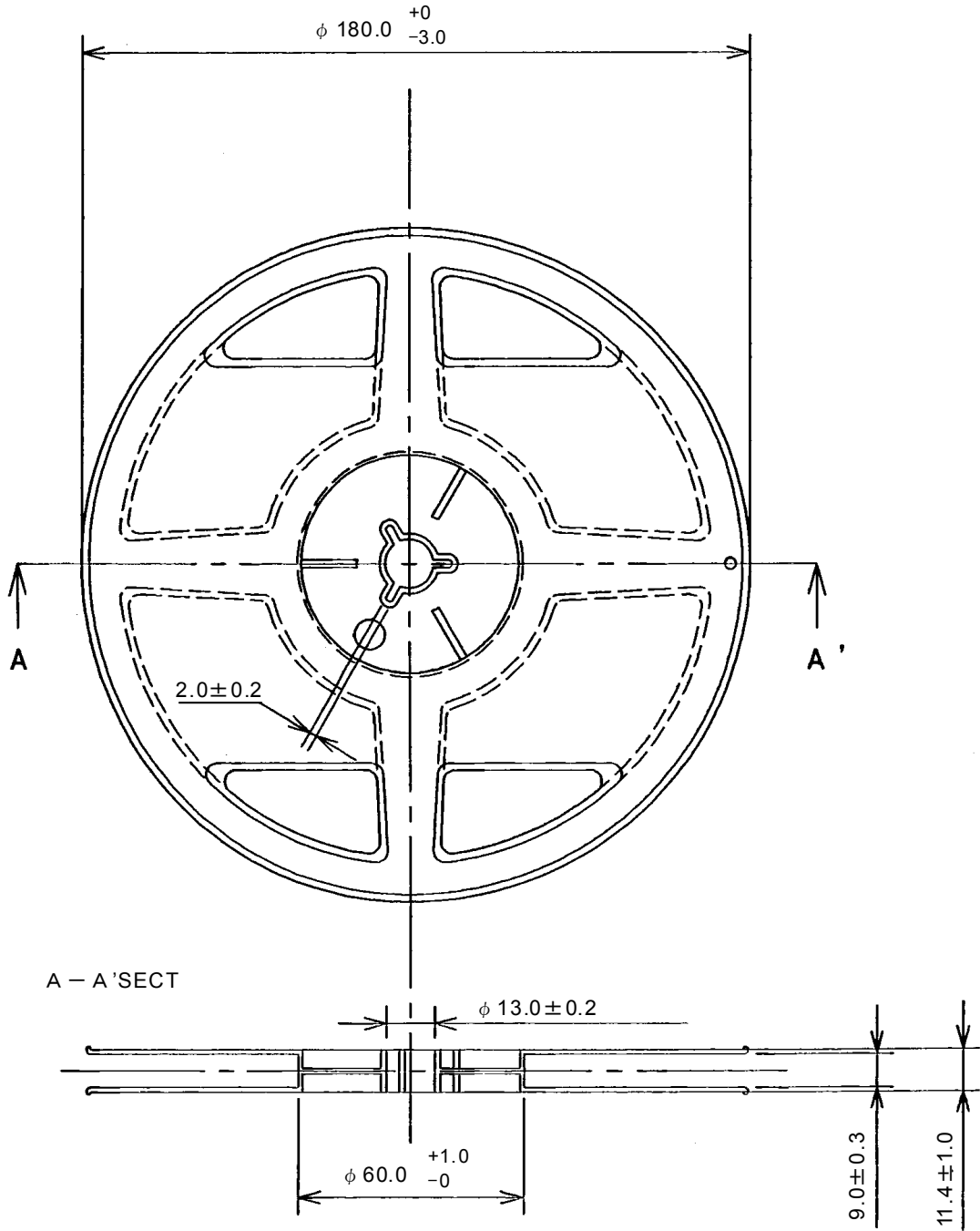

(Note1) This part is the application of JEITA ETX-7001.

2010-09-29		
Established	Revised	



<h1>Packing Specification</h1>		<b>LNJ8L4C28RAA</b>	
		Total pages	Page
		5	3

■ Taping specifications

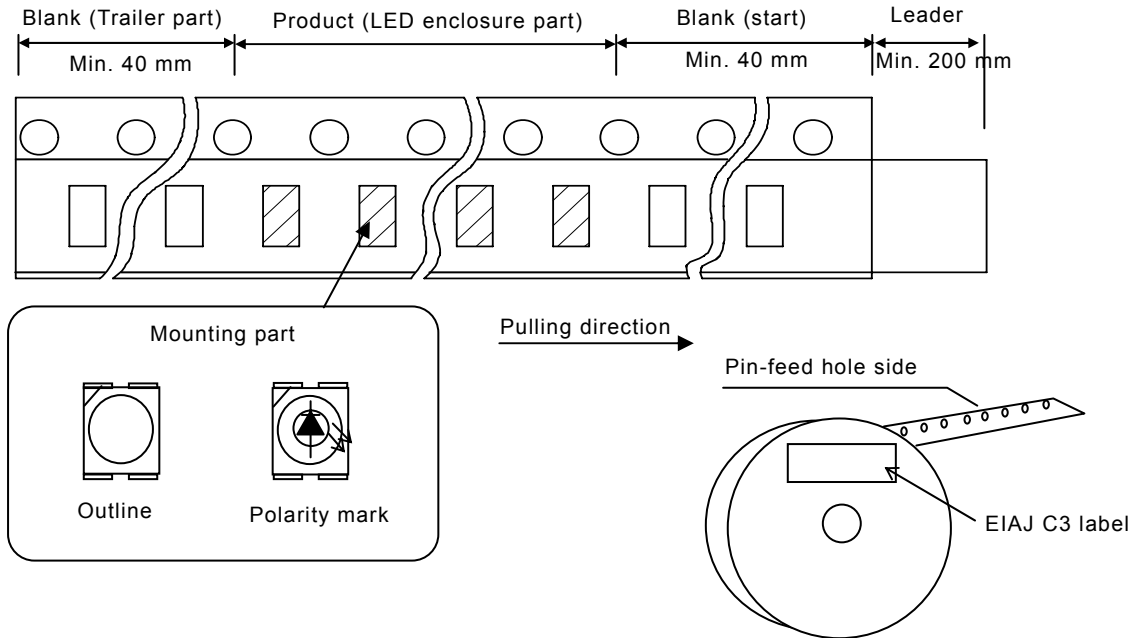

1. Pin-feed holes should be on the left side on the tape in the pulling direction.
2. Chip LED taping direction.  
Refer to the above Figure.
3. The leader part is saved as cover tape, which should be 200 mm or longer.
4. Keep more than 10 emboss blanks both at front and end of the taping.

■ Mechanical strength and treatment

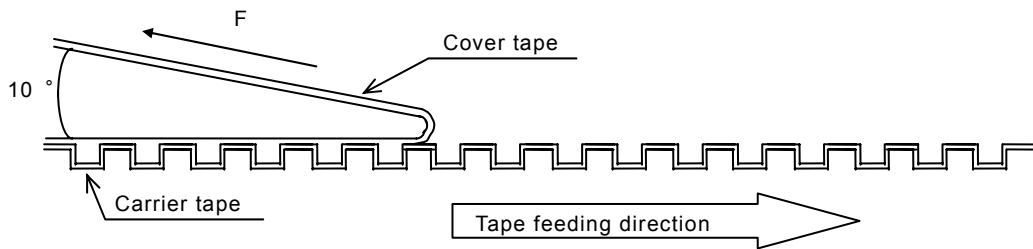

1. Exfoliation strength of the cover tape should be 0.19 N ~ 0.69 N.
2. Tape bending strength  
Tape should not be deformed by bending with a radius of 15 mm.
3. Percentage defective of enclosed  
The product which was enclosed in reverse direction or with back side up should be counted as 0 piece/reel.  
The number of dropped parts should be 0.1 % of entire number of parts or 1 piece, whichever larger.  
There should be no continuous dropping however total number has to remain intact.
4. There should be no tape joint.

2010-09-29		
Established	Revised	

<h1>Packing Specification</h1>		<b>LNJ8L4C28RAA</b>	
		Total pages	Page
		5	4

■ **Packing form**

1. A reel of 2 000 LED's is a basic unit.
2. A reel and silica gel are put into an aluminum lamination bag.

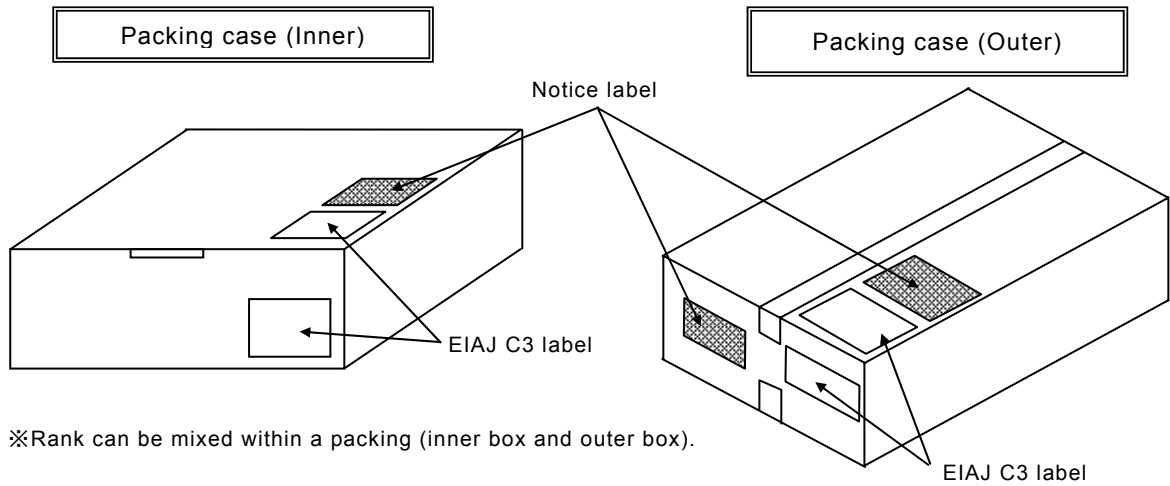
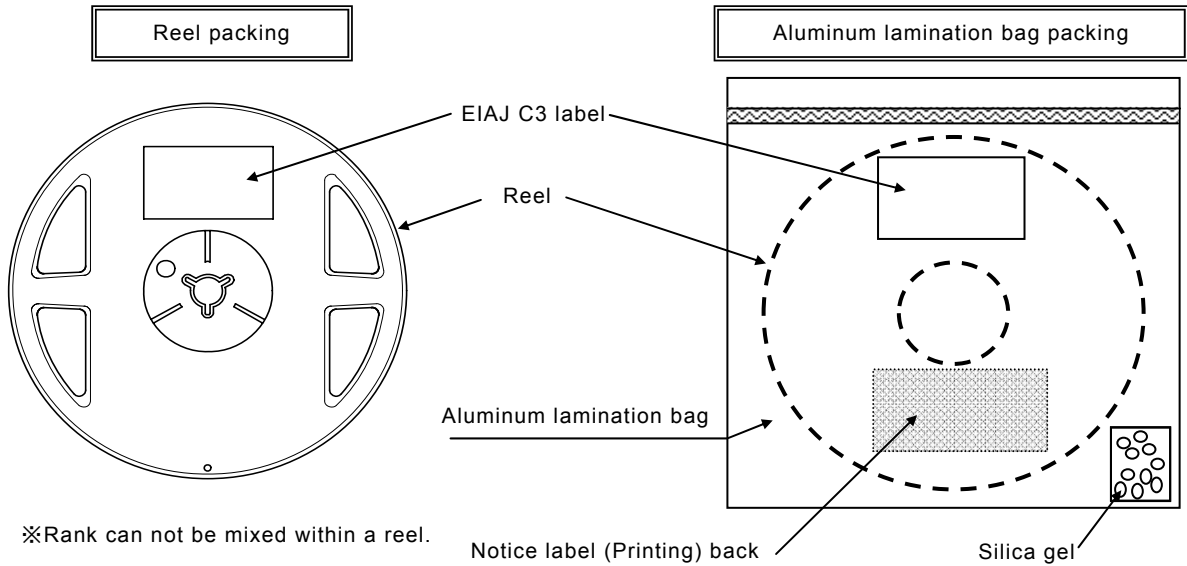

※Fractional packing, I,e, tape & reel and inner or outer carton, can be happened.

(Note) Please refer the product traceability with date code on the packing label.

2010-09-29		
Established	Revised	

■ Internal use Label Items

1. Packing Classification

- 1) Reel : 2 000 pcs
- 2) Packing (Inner) : 6 000 pcs
- 3) Packing (outer) : 12 000 pcs

2. Label

1) EIAJ C3 labeling

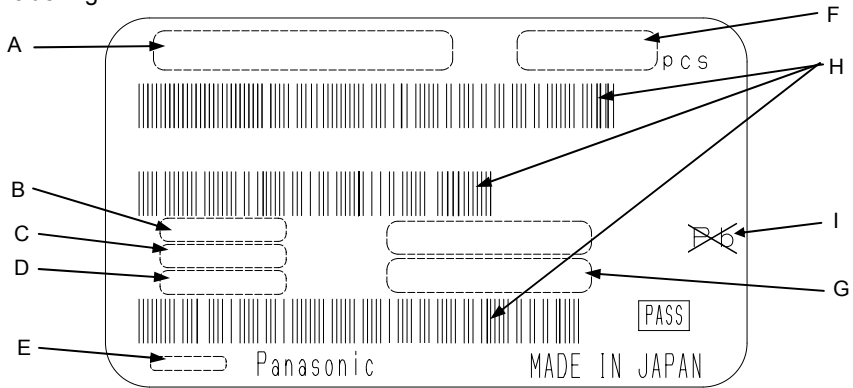

- A : Customer code
- B : Internal packing code
- C : Rank (Dominant Wavelength, Luminous Intensity, Forward Voltage)
- D : Date code

Example of date code

Date code of "09" indicates of Sep, 2010

(Reference) 09 ⇒ Sep, 2010

January	February	.....	October	November	December
1	2	.....	O	N	D

(October      November      December)

\* Only on the packing case tight number can be contained.

- E : Date of label printing
- F : Quantity
- G : Product number
- H : Bar code symbol
- I : Pb free

※ Product name indication (Example) LNJ8L4C28 RAA

Taping specifications

Chip LED product No.

2) Indication method (Notice label)

〔注意〕  
 本製品は、静電気に対して敏感な製品であり、その取り扱いには充分な注意が必要となります。特に、LEDの絶対最大定格を超えるような過電圧等が入った場合、そのエネルギーによってLEDにダメージを与えます。つきましてはLED取り扱いに於きまして、万全なる静電気・サージ対策をおとり下さい。

〔NOTICE〕  
 This LED is sensitive to static electricity and care should be fully taken in handling it. Particularly, when an overvoltage is applied, which exceeds the absolute maximum rating of the LED, its energy damages the LED. Therefore, take utmost proactive measures against static electricity and surge as to building an assembly line and handling the LED halfway the process.

 <b>ATTENTION</b> OBSERVE PRECAUTION FOR HANDLING ELECTRO STATIC SENSITIVE DEVICES 静電気注意	PCS
---	-----

2010-09-29		
Established	Revised	

	<h1>Reliability Test Result</h1>	<b>LNJ8L4C28RAA</b>	
		Total pages	Page
		1	1

Product Name : LNJ8L4C28RAA

Issued by	Reaffirmed by
Panasonic Semiconductor Opto Devices Co., Ltd. Quality control group	

◆The examination is a representative characteristic of the product, and not a guaranteed performance.

Item	Test Condition	N Qt.	Judgment Criteria
Consecutive operating life test	Ta=25 °C, I <sub>F</sub> =70 mA DC, t=1 000 h	20	B
High temperature operating life test	Ta=105 °C, I <sub>F</sub> =20 mA DC, t=1 000 h	20	B
High temperature humidity operating life test	Ta=85 °C, RH=85 %, I <sub>F</sub> =50 mA DC, t=1 000 h	20	B
High temperature storage life test	Ta=125 °C, t=1 000 h	20	B
High temperature humidity storage life test	Ta=85 °C, RH=85 %, t=1 000 h	20	B
Low temperature storage life test	Ta=-40 °C, t=1 000 h	20	B
Soldering heat test	Ta=260 °C Max. (Ta=250 °C, t=10 s Max.) Reflow soldering 2 times	10	A
Temperature cycle test (Gaseous phase)	Temperature: [-40 °C~25 °C~125 °C~25 °C] Time : (30 min 5 min 30 min 5min ) × 500 cycles	20	B
HBM/ESD	1.5 kΩ, 100 pF, ±1 kV, 3 times	20	C

◆Judgment Criteria A

Item	Symbol	Measurement condition	Limit	Unit
Forward Voltage	V <sub>F</sub>	I <sub>F</sub> =50 mA DC	Upper Limit × 1.2	V
Luminous Intensity	I <sub>O</sub>	I <sub>F</sub> =50 mA DC	Lower Limit × 0.7	mcd

◆Judgment Criteria B

Item	Symbol	Measurement condition	Limit	Unit
Forward Voltage	V <sub>F</sub>	I <sub>F</sub> =50 mA DC	Upper Limit × 1.2	V
Luminous Intensity	I <sub>O</sub>	I <sub>F</sub> =50 mA DC	Lower Limit × 0.5	mcd

◆Judgment Criteria C

Item	Symbol	Measurement condition	Limit	Unit
Reverse Leakage Current	I <sub>R</sub>	V <sub>R</sub> =5 V	100 μA Max.	μA

(Note)

Please consult about use excluding the above-mentioned and the examination item for the idea.

2010-09-29		
Established	Revised	

