

UTC Series Installation Accessories

Introduction

The UTC series installation accessories blend simplicity with style. It makes optimal use of space, and its compact design saves money in shipping fees. UTC-5 Series is elegantly designed to fit many different customer scenarios, from kiosks to reception areas. The slim and stylish unit is easy to store, easy to ship and easy to set up. Installation is simple; it can be done in about ten minutes and the finished result makes an attractive, one-piece solution.

Wall Mount

| PN | UTC-WALL-MOUNT1E | UTC-WALL-MOUNT2E | UTC-WALL-MOUNT3E | UTC-WALL-MOUNT4E |
|------------------------|-----------------------------|------------------|-----------------------------|------------------|
| VESA Mounting Patterns | 75 x 75 mm; 100 x 100 mm | 200 x 200 mm | 75 x 75 mm; 100 x 100 mm | 75 x 75 mm |
| Weight Capacity | 14 kg | 35 kg | 20 kg | 20 kg |

UTC-WALL-MOUNT1E

VESA 75/100 mm



- Firmly fix to a solid wall
- Weight capacity up to 14 kg
- Material: Steel
- Tilt: 180° up and down

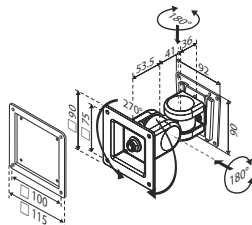

- Rotation: 270° for portrait or landscape viewing
- Lift: 130.5 mm
- For UTC-510/515/520/307/310/315

UTC-WALL-MOUNT2E

VESA 100/200 mm



- Flush fit without movement
- Weight capacity up to 35 kg
- Material: Steel

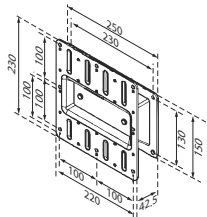

- Sits: 42.5 mm from the wall
- For UTC-532 only

UTC-WALL-MOUNT3E

VESA 75/100 mm



- Firmly fix to a solid wall
- Weight capacity up to 20 kg
- Material: Steel

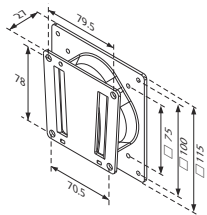

- Sits: 27 mm from the wall
- For UTC-515/520/307/310/315/318/320

UTC-WALL-MOUNT4E

VESA 75 mm



- Handy and Convenient supporter
- Firmly fix to solid wall
- Material: Steel

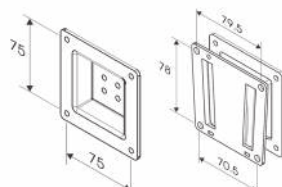

- Weight capacity up to 20 kg
- For UTC-510/307/310

Floor Stand

| PN | UTC-T01-STANDE | UTC-H01-STANDE |
|------------------------|----------------------------|---|
| Description | Triangle shape floor stand | H-shape floor stand |
| VESA Mounting Patterns | 75 x 75 mm; 100 x 100 mm | 75 x 75 mm; 100 x 100 mm; 200 x 200 mm |
| Height | 120 cm | 120 cm |
| Dimension | Ø660 mm | 558 x 510 mm |
| Weight | 10 kg | 10 kg |
| Weight Capacity | 18 KG (39.6lbs) | |

UTC-T01-STANDE

Triangle shape floor stand

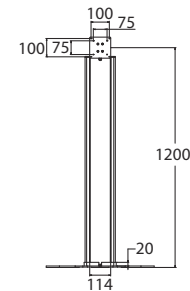
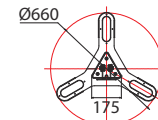

- Organized cable management
- VESA 75/100 mm
- Height: 120 cm
- Easily tilt for best viewing comfort
- Dimension: Ø660 mm
- For UTC 515/520/315/318/320

UTC-H01-STANDE

H-shape floor stand

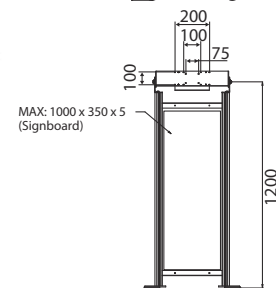
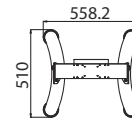

MAX: 1000 x 350 x 5 (Signboard)

- Organized cable management
- VESA 75/100/200mm
- Height: 120 cm
- Easily tilt for best viewing comfort
- Dimension: 558 x 510 mm
- Acrylics signboard is excluded
- For UTC 515/520/532/315/318/320

UTC Series Installation Accessories

Desktop Stand

| PN | UTC-S01-STAND | UTC-S03-STANDE | UTC-510-STAND0E | UTC-520-STAND1E |
|------------------------|---|---|---|-----------------------|
| Description | Tilttable Desktop Stand | Tilttable Desktop Stand | UTC-510 desktop stand with adapter holder | UTC-520 desktop stand |
| VESA Mounting Patterns | 75 x 75 mm; 100 x 100 mm | 75 x 75 mm | 75 x 75 mm | N/A |
| Dimension | 203 x 275 x 227 mm (8" x 10.83" x 8.94") | 203 x 213 x 227 mm (7.99" x 8.39" x 8.94") | 240L x 215W x 290H | 230L x 160W x 44H |
| Weight | 1.75kg | 2kg | 0.85kg | 0.4kg |
| Weight Capacity | 15kg | 13kg | 2.5kg | 13kg |

UTC-S01-STAND

VESA 75 x 75 mm ; 100 x 100 mm

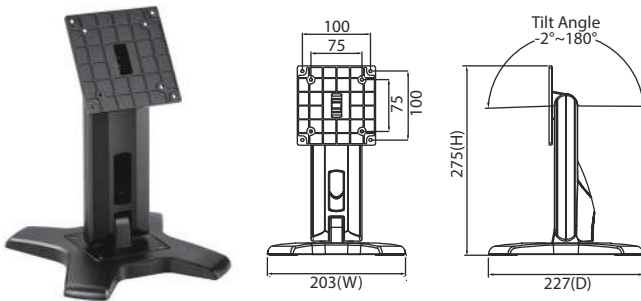

- Mounting Pattern: 100 x 100 / 75 x 75 mm
- Screw Type: M4
- Material: Steel/Plastic/Aluminum
- Dimension (W x H x D): 203 x 275 x 227 mm (8" x 10.83" x 8.94")
- Weight (Net): 1.75 Kg (3.86lbs)
- Tilt (Hinge): +180° / -2°
- Support Max.Weight: 15kg (33.1lbs)
- Support UTC-515/520 /307/310/315/318/320

UTC-S03-STANDE

VESA 75 x 75 mm

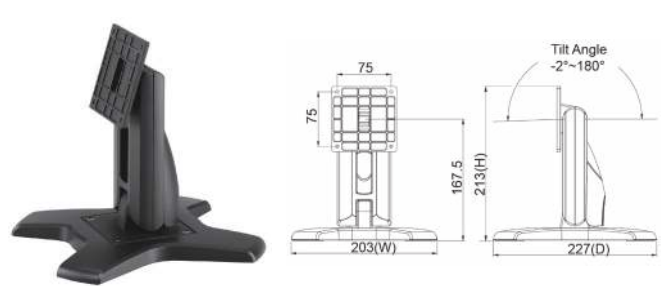

- Mounting Pattern: 75 x 75 mm
- Screw Type: M4
- Material: Steel/Plastic/Zinc
- Dimension (W x H x D): 203 x 213 x 227 mm (7.99" x 8.39" x 8.94")
- Weight (Net): 1.60 Kg (3.53lbs)
- Tilt (Hinge): +180° / -2°
- Support Max.Weight: 13kg (28.7lbs)
- Support UTC Models: UTC-510/307/310

UTC-510-STAND0E

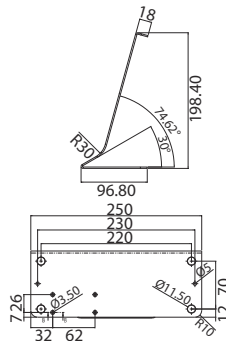

- Material: Steel
- Dimension: 240L x 215W x 290H
- Weight (Net): 0.85kg
- Support Flat Panel Size: 10"
- Support Max Weight: 2.5kg
- For UTC-510

UTC-520-STAND1E

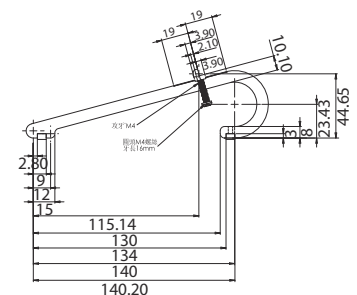

- Material: Steel
- Dimension: 230L x 160W x 44H
- Weight (Net): 0.4kg
- Support Max.Weight: 13kg (28.7lbs)
- Support UTC Models: UTC-515 and 520 series