

DATA SHEET

SHUNT RESISTOR AUTOMOTIVE GRADE

PU series

5%, 1%

sizes

2512/ 3921/ 5931

RoHS compliant & Halogen free



SCOPE

This specification describes shunt resistor PU series made by welding technology.

APPLICATIONS

- Power
- Telecom base station
- Automotive (Headlight/ Window control/ Engine control unit/ Steering control...)
- Alternative energy

FEATURES

- AEC-Q200 qualified
- Total lead free without RoHS exemption
- Resistance value down to 0.0001Ω and high power up to 15W
- Welding metal plate construction

YAGEO will eliminate the resistance value marking on the PU3921 on Feb. 8th, 2023 and the samples without marking will be available on Aug. 8th, 2022. The Product Change Notification number is EBR-0176-22070801.

ORDERING INFORMATION - GLOBAL PART NUMBER

Global part numbers are identified by the series, size, tolerance, packing type, temperature coefficient, taping reel and resistance value.

GLOBAL PART NUMBER

PU XXXX X X X XX XXXX L
 (1) (2) (3) (4) (5) (6) (7)

(1) SIZE

2512/ 3921/ 5931

(2) TOLERANCE

F = ±1% J = ±5%

(3) PACKAGING TYPE

K = Embossed taping reel

(4) TEMPERATURE COEFFICIENT OF RESISTANCE

M = ±75 ppm/°C

N = ±175 ppm/°C

G = ±200 ppm/°C

H = ±225 ppm/°C

I = ±300 ppm/°C

O = ±325 ppm/°C

(5) TAPING REEL

I3 = 13 inch Dia. reel, standard power, 4W for 2512, 3W for 3921 and 5W for 5931

P5 = 5W, 13 inch Dia. reel

P6 = 6W, 13 inch Dia. Reel

P7 = 7W, 13 inch Dia. reel

P9 = 9W, 13 inch Dia. reel

T3 = 3W, High temperature 13 inch Dia. reel

T5 = 5W, High temperature 13 inch Dia. reel

PA = 10W, 13 inch Dia. Reel

PB = 15W, 13 inch Dia. Reel

PC = 12W, 13 inch Dia. Reel

(6) RESISTANCE VALUE

0.1 mΩ to 5 mΩ

There are 3~5 digits indicated the resistance value. Letter R/ U is decimal point.

Detailed coding rules of resistance are shown in the table of "Resistance rule of global part number".

(7) DEFAULT CODE

Letter L is the system default code for ordering only. (Note)

Resistance rule of global part number	
Resistance code rule	Example
0RXXX	0R001 = 1 mΩ
0UX	0U2 = 0.0002 Ω

ORDERING EXAMPLE

The ordering code of a PU3921, value 0.0005Ω with ±1% tolerance, 3W and high temperature(275 °C) supplied in 13-inch tape reel is :
PU3921FKNT30U5L

NOTE

1. All our RSMD products are RoHS compliant. "LFP" of the internal 2D reel label mentions "Lead-Free Process"

MARKING

PU2512 / 5931

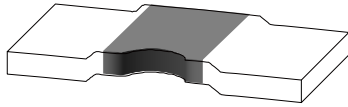

No marking

Fig. 1 Value = 0.2mΩ

PU3921 - 0.1~0.7mΩ

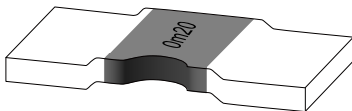

4 digits

The "m" is used as a decimal point ; the other 3 digits are significant and the unit is milliohm
0.1mΩ to 0.7mΩ

Fig. 2 Value = 0.2mΩ

PU3921 - 1~5mΩ

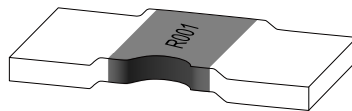

4 digits

The "R" is used as a decimal point ; the other 3 digits are significant
1mΩ to 5mΩ

Fig. 3 Value = 1mΩ

NOTE: There will be a short period of time that both types of PU3921, with marking and without marking, exist simultaneously in the market. The exterior of PU3921 without marking is shown in Fig. 1

OUTLINES AND DIMENSION

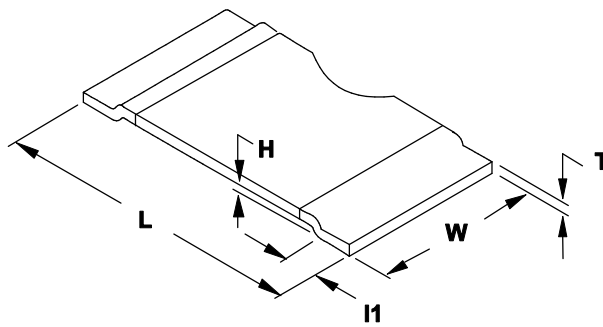

Fig. 4-1 Chip resistor outlines

Table I-1 For outlines, please refer to Fig. 3-1

TYPE	L (mm)	W (mm)	H (mm)	l1 (mm)
PU2512	6.35±0.25	3.18±0.25	0.35±0.15	1.14±0.25
PU3921	10.0±0.25	5.20±0.25	0.50±0.13	2.00±0.25
PU5931	15.0±0.25	7.75±0.25	0.50±0.13	4.00±0.25

Resistance Value	0.1mΩ	0.2mΩ	0.25mΩ	0.3 mΩ	0.4mΩ	0.5 mΩ	0.7 mΩ	1 mΩ	2 mΩ	3 mΩ	4 mΩ	5 mΩ
T (mm)	---	---	---	0.95±0.13	0.75±0.13	0.84±0.13	---	0.43±0.13	0.66±0.13	0.44±0.13	0.33±0.13	0.31±0.13
Thickness	---	1.35±0.13	1.05±0.10	1.35±0.13	1.05±0.13	0.86±0.13	0.60±0.10	0.43±0.13	0.72±0.13	0.48±0.13	0.36±0.13	0.25±0.13
	1.42±0.13	1.33±0.13	---	1.00±0.13	---	0.60±0.13	---	0.33±0.13	0.49±0.13	0.33±0.13	0.25±0.13	---

ELECTRICAL CHARACTERISTICS

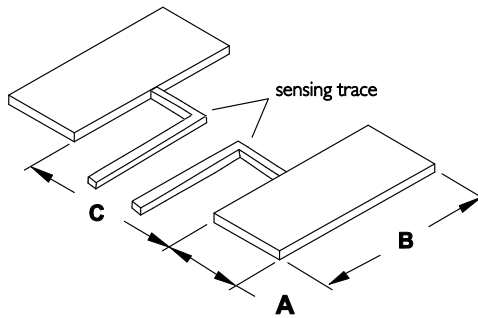

Fig. 4-2 Solder pad dimensions

YHSC192_1

Note: Series resistors are suitable for IR reflow soldering

Table 1-2 For outlines, please refer to Fig. 4-2

TYPE	A (mm)	B (mm)	C (mm)
PU2512	1.80±0.15	3.40±0.15	3.40±0.13
PU3921	2.75±0.25	6.20±0.25	5.60±0.13
PU5931	5.20±0.25	8.75±0.25	5.60±0.13

Table 2

SIZE	POWER RATING ⁽⁴⁾	OPERATING TEMP. RANGE	RESISTANCE RANGE	TOLERANCE ⁽²⁾	TEMPERATURE COEFFICIENT OF RESISTANCE ⁽³⁾
PU2512	4W(I3)	-65°C to 170°C	3/ 4/ 5mΩ	±1% (F) ±5% (J)	0.3/ 0.4/ 0.5mΩ: ±200ppm/°C (G)
	5W(P5)		1/ 2mΩ		1mΩ: ±175ppm/°C (N)
	6W(P6)		0.3/ 0.4/ 0.5mΩ		2~5mΩ: ±75ppm/°C (M)
PU3921	3W(I3)	-65°C to 170°C	0.2/ 0.25/ 0.3/ 0.4/ 0.5/ 0.7mΩ 1/ 2/ 3/ 4/ 5mΩ	±1% (F) ±5% (J)	0.2/ 0.25/ 0.3/ 0.4/ 0.5/ 0.7mΩ: ±175ppm/°C (N) 1~5mΩ: ±75ppm/°C (M)
	5W(P5)		0.2/ 0.25/ 0.3/ 0.4/ 0.5/ 0.7mΩ 1/ 2/ 3/ 4/ 5mΩ		0.2mΩ: ±325ppm/°C (O)
	9W(P9)		0.2/ 0.25/ 0.3/ 0.4/ 0.5/ 0.7/ 1mΩ		0.2/ 0.25/ 0.3/ 0.4/ 0.5/ 0.7mΩ: ±175ppm/°C (N) 1~5mΩ: ±75ppm/°C (M)
	10W(PA)	-65°C to 275°C	0.2/ 0.3/ 0.5mΩ	±1% (F) ±5% (J)	0.2mΩ: ±225ppm/°C (H) 0.3/ 0.5mΩ: ±175ppm/°C (N)
	12W(PC)		0.5mΩ: ±175ppm/°C (N) 1~4mΩ: ±75ppm/°C (M)		
	PU5931	3W(T3)	-65°C to 275°C	0.2/ 0.3/ 0.5/ 1/ 2/ 3/ 4mΩ	±1% (F) ±5% (J)
5W(I3)		0.2/ 0.3/ 0.5mΩ		0.1mΩ: ±300ppm/°C (I)	
7W(P7)		0.2/ 0.3/ 0.5mΩ		0.2mΩ: ±225ppm/°C (H)	
10W(PA)		0.1mΩ		0.3/ 0.5mΩ: ±175ppm/°C (N) 1~4mΩ: ±75ppm/°C (M)	
15W(PB)		0.3/ 0.5mΩ: ±175ppm/°C (N) 1~4mΩ: ±75ppm/°C (M)			

Note: 1. Please contact with sales offices, distributors and representatives in your region before ordering.

2. Global part number (code7)
3. Global part number (code 9)
4. Global part number (code 10-11)

FUNCTIONAL DESCRIPTION

OPERATING TEMPERATURE RANGE

High Temperature Range Type:
-65°C to +275°C (Fig. 5-1)

Normal Temperature Range Type:
-65°C to +170°C (Fig. 5-2)

POWER RATING

Standard rated power at 70°C:

- PU2512 = 4W
- PU3921 = 3W
- PU5931 = 5W

For detail power value, please refer to Table 2.

RATED VOLTAGE

The DC or AC (rms) continuous working voltage corresponding to the rated power is determined by the following formula:

$$V = \sqrt{P \times R}$$

Where

V = Continuous rated DC or AC (rms) working voltage (V)

P = Rated power (W)

R = Resistance value (Ω)

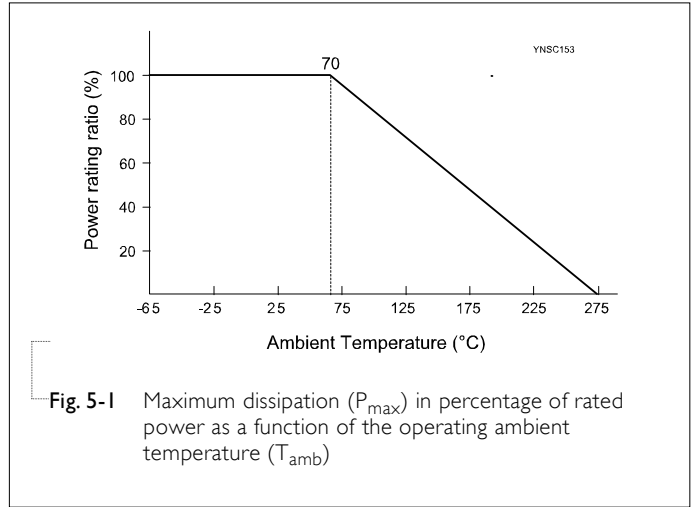

Fig. 5-1 Maximum dissipation (P_{max}) in percentage of rated power as a function of the operating ambient temperature (T_{amb})

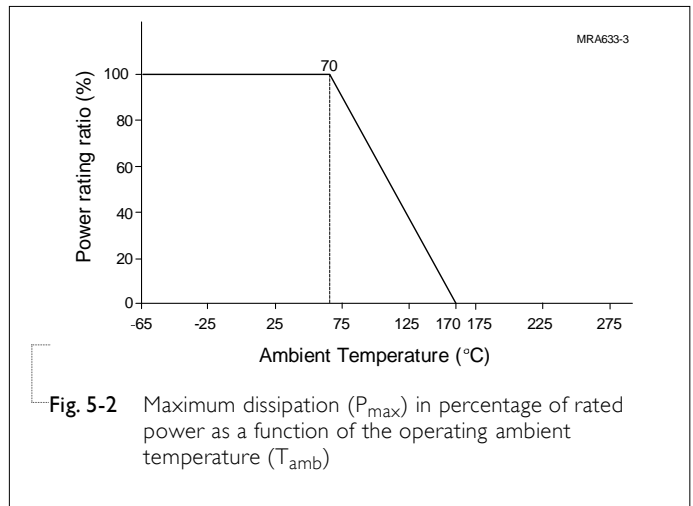

Fig. 5-2 Maximum dissipation (P_{max}) in percentage of rated power as a function of the operating ambient temperature (T_{amb})

PACKING STYLE AND PACKAGING QUANTITY

Table 3 Packing style and packaging quantity

PACKING STYLE	REEL DIMENSION	2512	3921	5931
Embossed taping reel (K)	13" (330 mm)	4,000	3,000	1,500

EMBOSSED TAPE

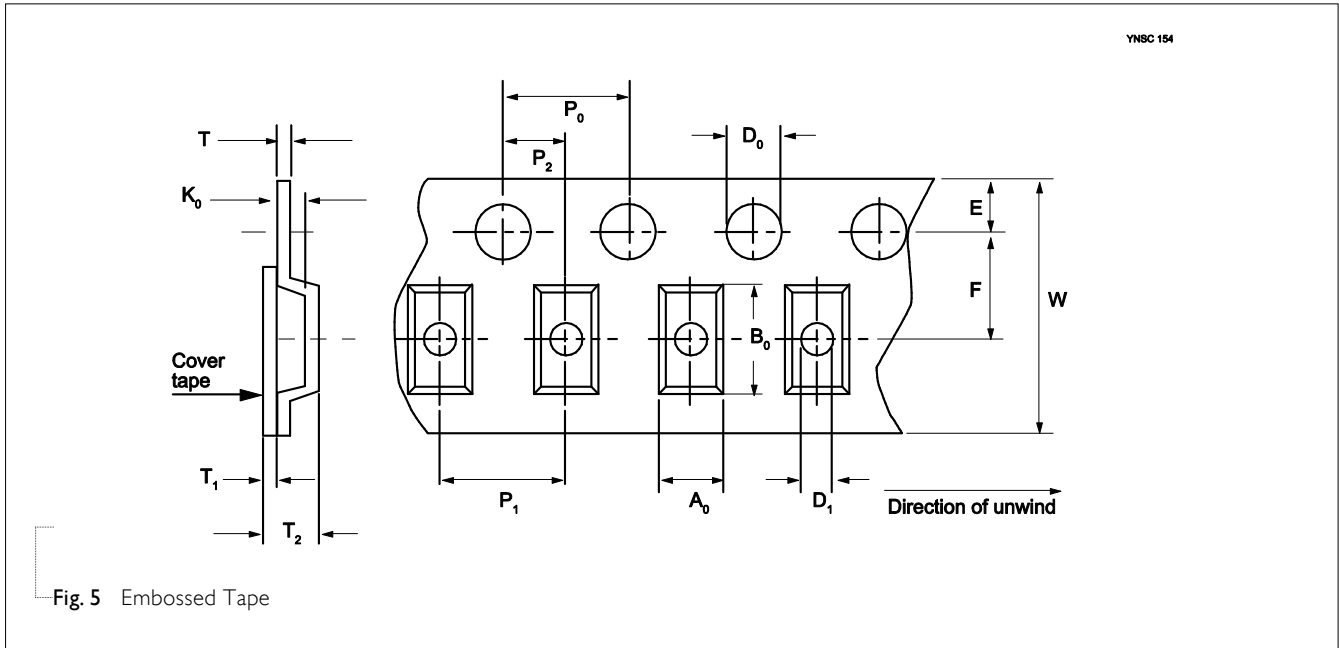

Fig. 5 Embossed Tape

Table 4 Dimensions of embossed tape for relevant chip resistors size

DIMENSION	A ₀	B ₀	D ₀	D ₁ MIN.	E	F	K ₀ MAX.	P ₀	P ₁	P ₂	T ₁ MAX.	T ₂ MAX.	T MAX.	W MAX.
PU2512														
0.3/ 0.4 /0.5 /2mΩ	3.58±0.1	6.7±0.1	1.5±0.1	1.5	1.75±0.1	5.5±0.1	1.52	4±0.1	8±0.1	2±0.1	0.1	1.92	0.3	12.3
1 /3 /4 /5mΩ	3.58±0.1	6.7±0.1	1.5±0.1	1.5	1.75±0.1	5.5±0.1	1.14	4±0.1	8±0.1	2±0.1	0.1	1.54	0.3	12.3
PU3921														
0.2/ 0.25/ 0.3/ 0.4 0.5 / 0.7/ 2mΩ	5.59±0.1	10.41±0.1	1.5±0.1	1.5	1.75±0.1	7.5±0.1	2.13	4±0.1	8±0.1	2±0.1	0.1	2.64	0.41	16.3
1 /3 /4 /5mΩ	5.59±0.1	10.41±0.1	1.5±0.1	1.5	1.75±0.1	7.5±0.1	1.14	4±0.1	8±0.1	2±0.1	0.1	1.65	0.41	16.3
PU5931														
≤ 0.3mΩ	8.3±0.1	15.62±0.1	1.5±0.1	1.5	1.75±0.1	11.5±0.1	2.39	4±0.1	12±0.1	2±0.1	0.1	2.9	0.41	24.3
≥ 0.5mΩ	8.3±0.1	15.62±0.1	1.5±0.1	1.5	1.75±0.1	11.5±0.1	1.22	4±0.1	12±0.1	2±0.1	0.1	1.73	0.41	24.3

Unit : mm

REEL SPECIFICATION

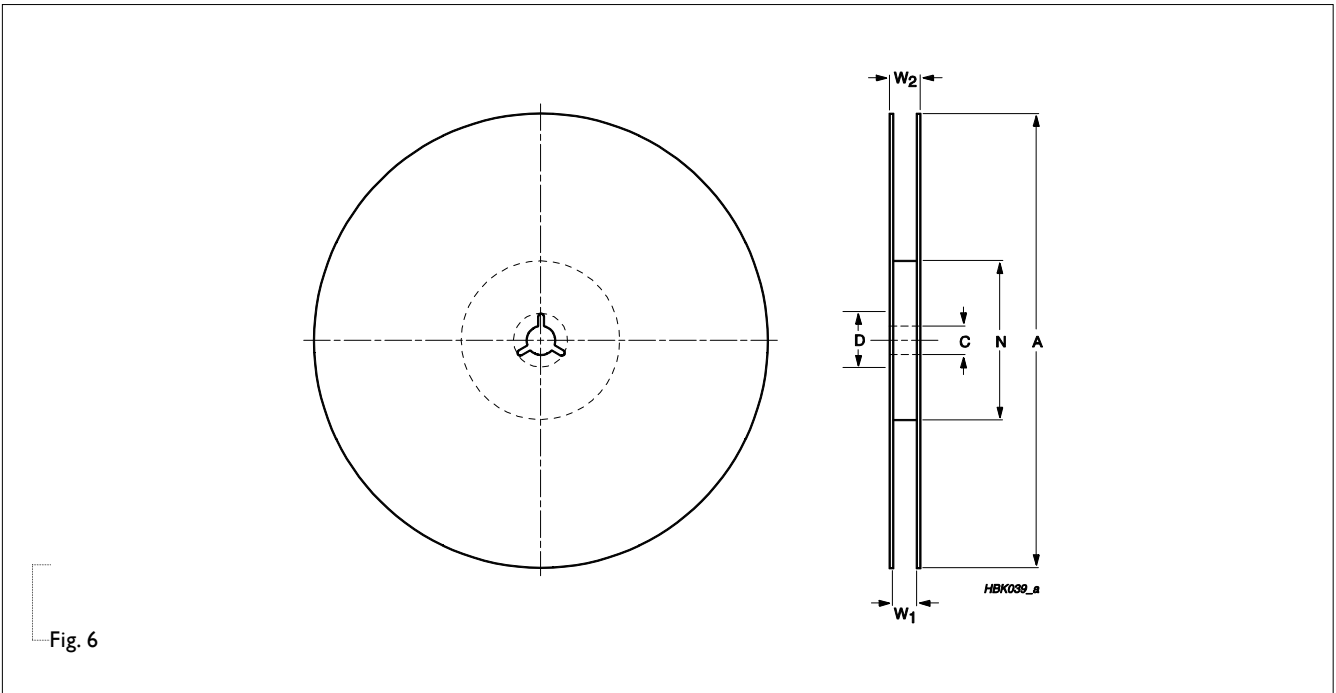

Fig. 6

Table 5 Dimensions of reel specification for relevant chip resistors size; see Fig. 6

PRODUCT SIZE CODE	REEL SIZE	SYMBOL					
		A	N	C	D	W1	W2 max.
2512	13" (Φ 330mm)	330+0 /-3	100±0.5	13.5±0.5	21±0.8	13±0.3	17.5
3921	13" (Φ 330mm)	330+0 /-3	100±0.5	13.5±0.5	21±0.8	16.4+2.0/-0	22.4
5931	13" (Φ 330mm)	330+0 /-3	100±0.5	13.5±0.5	21±0.8	24.4+2.0/-0	30.4

Unit : mm

TESTS AND REQUIREMENTS

Table 6 Test condition, procedure and requirements

TEST	TEST METHOD	PROCEDURE	REQUIREMENTS
Short Time Overload	IEC60115-1 4.13	5 times of rated power for 5 seconds at room temperature	$\pm(1\%+0.0005 \Omega)$ No visible damage
High Temperature Exposure	AEC-Q200 Test 3 MIL-STD-202 method 108A IEC 60115-1 4.25.3	1,000 hours at maximum operating temperature depending on specification, unpowered, Normal Temperature Range Type: $170\pm 3^{\circ}\text{C}$ High Temperature Range Type: $275\pm 5^{\circ}\text{C}$	$\pm(1\%+0.0005 \Omega)$
Moisture Resistance	AEC-Q200 Test 6 MIL-STD-202 method 106F	Each temperature / humidity cycle is defined at 8 hours (method 106F), 3 cycles / 24 hours for 10d with $25^{\circ}\text{C} / 65^{\circ}\text{C}$ 95% R.H, without steps 7a & 7b, unpowered Parts mounted on test-boards, without condensation on parts Measurement at 24 ± 2 hours after test conclusion	$\pm(1\%+0.0005 \Omega)$
Biased Humidity	AEC-Q200 Test 7 MIL-STD-202 method 103	1,000 hours; $85^{\circ}\text{C} / 85\% \text{RH}$ 10% of operating power Measurement at 24 ± 4 hours after test conclusion.	$\pm(1\%+0.0005 \Omega)$
Life/ Operational Life/ Endurance	AEC-Q200 Test 8 MIL-STD-202 method 108A IEC 60115-1 4.25.1	1,000 hours at $70\pm 5^{\circ}\text{C}$ applied RCWV 1.5 hours on, 0.5 hour off, still air required	$\pm(1\%+0.0005 \Omega)$
- Resistance to Soldering Heat	AEC-Q200 Test 15 MIL-STD-202 method 210F IEC 60115-1 4.18	Condition B, no pre-heat of samples Lead free solder, 260°C , 10 seconds immersion time Procedure 2 for SMD: devices fluxed and cleaned with isopropanol	$\pm(0.5\%+0.0005 \Omega)$ No visible damage
Thermal Shock	AEC-Q200 Test 16 MIL-STD-202 method 107	$-55/+150^{\circ}\text{C}$ Number of cycles is 300. Maximum transfer time is 20 seconds. Dwell time is 15 minutes. Air – Air	$\pm(1\%+0.0005 \Omega)$ No visible damage
Board Flex / Bending	AEC-Q200 Test 21 AEC-Q200-005	Chips mounted on a 90mm glass epoxy resin PCB (FR4) Bending: 2 mm Holding time: minimum 60 seconds	$\pm(1\%+0.0005 \Omega)$

REVISION HISTORY

REVISION	DATE	CHANGE NOTIFICATION	DESCRIPTION
Version 9	July 08, 2022	-	- Notify our clients YAGEO will eliminate resistance value marking on the PU3921
Version 8	Aug. 02, 2021	-	- Notify our clients that YAGEO will eliminate resistance value marking on the PU5931
Version 7	Apr. 15, 2021	-	- Extend resistor value for 2512 and power rating for 3921
Version 6	Apr. 03, 2019	-	- Extend resistor value for 3921
Version 5	Jun. 28, 2018	-	- Update packing quantity for PU2512
Version 4	Nov. 23, 2017	-	- Added in PU2512
Version 3	May 24, 2017	-	- Added in thickness for 3921 0.4mΩ
Version 2	Jan. 16, 2017	-	- Extend resistor value
Version 1	Jun. 15, 2016	-	- Extend resistor value
Version 0	Mar. 16, 2016	-	- New datasheet for shunt resistor PU series

“Yageo reserves all the rights for revising the content of this datasheet without further notification, as long as the products itself are unchanged. Any product change will be announced by PCN.”

LEGAL DISCLAIMER

YAGEO, its distributors and agents (collectively, "YAGEO"), hereby disclaims any and all liabilities for any errors, inaccuracies or incompleteness contained in any product related information, including but not limited to product specifications, datasheets, pictures and/or graphics. YAGEO may make changes, modifications and/or improvements to product related information at any time and without notice.

YAGEO makes no representation, warranty, and/or guarantee about the fitness of its products for any particular purpose or the continuing production of any of its products. To the maximum extent permitted by law, YAGEO disclaims (i) any and all liability arising out of the application or use of any YAGEO product, (ii) any and all liability, including without limitation special, consequential or incidental damages, and (iii) any and all implied warranties, including warranties of fitness for a particular purpose, non-infringement and merchantability.

YAGEO products are designed for general purpose applications under normal operation and usage conditions. Please contact YAGEO for the applications listed below which require especially high reliability for the prevention of defects which might directly cause damage to the third party's life, body or property: Aerospace equipment (artificial satellite, rocket, etc.), Atomic energy-related equipment, Aviation equipment, Disaster prevention equipment, crime prevention equipment, Electric heating apparatus, burning equipment, Highly public information network equipment, data-processing equipment, Medical devices, Military equipment, Power generation control equipment, Safety equipment, Traffic signal equipment, Transportation equipment and Undersea equipment, or for any other application or use in which the failure of YAGEO products could result in personal injury or death, or serious property damage. Particularly **YAGEO Corporation and its affiliates do not recommend the use of commercial or automotive grade products for high reliability applications or manned space flight.**

Information provided here is intended to indicate product specifications only. YAGEO reserves all the rights for revising this content without further notification, as long as products are unchanged. Any product change will be announced by PCN.