

# OPA856 1.1-GHz Unity-Gain Bandwidth, 0.9 nV/ $\sqrt{\text{Hz}}$ , Bipolar Input Amplifier

## 1 Features

- Unity-gain bandwidth: 1.1 GHz
- Gain bandwidth product: 1.1 GHz
- Slew rate: 350 V/ $\mu\text{s}$
- Low input voltage noise: 0.9 nV/ $\sqrt{\text{Hz}}$
- Low input capacitance:
  - Common-mode: 0.4 pF
  - Differential: 0.7 pF
- Supply voltage range: 3.3 V to 5.25 V
- Package: 8-pin WSON
- Temperature range:  $-40^{\circ}\text{C}$  to  $+125^{\circ}\text{C}$

## 2 Applications

- [Optical time domain reflectometry \(OTDR\)](#)
- [3D scanner](#)
- [Laser distance measurement](#)
- [Solid-state scanning LIDAR](#)
- [Optical ToF position sensor](#)
- [Drone vision](#)
- [Industrial robot LIDAR](#)
- [Vaccum robot LIDAR](#)
- Silicon photomultiplier (SiPM) buffer amplifier
- Photomultiplier tube post amplifier

## 3 Description

The OPA856 is a wideband, low-noise operational amplifier with bipolar inputs for wideband transimpedance and voltage amplifier applications. When the device is configured as a transimpedance amplifier (TIA), the 1.1-GHz gain bandwidth product (GBWP) enables high closed-loop bandwidths in low-capacitance photodiode applications.

The graph below shows the bandwidth and noise performance of the OPA856 as a function of the photodiode capacitance when the amplifier is configured as a TIA. The total noise is calculated along a bandwidth range extending from DC to the calculated frequency ( $f$ ) on the left scale. The OPA856 package has a feedback pin (FB) that simplifies the feedback network connection between the input and the output.

The OPA856 is optimized to operate in optical time-of-flight (ToF) systems where the OPA856 is used with time-to-digital converters, such as the [TDC7201](#). Use the OPA856 to drive a high-speed analog-to-digital converter (ADC) in high-resolution LIDAR systems with a differential output amplifier, such as the [THS4541](#) or [LMH5401](#).

### Device Information

PART NUMBER <sup>(1)</sup>	PACKAGE	BODY SIZE (NOM)
OPA856	WSON (8)	2.00 mm × 2.00 mm

(1) See the package option addendum at the end of the data sheet for all available packages.

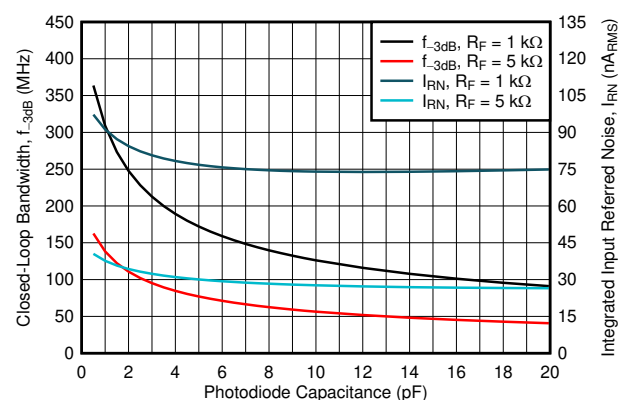
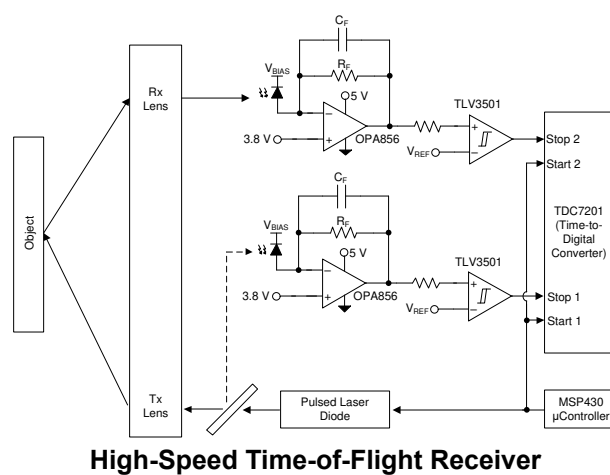

**Photodiode Capacitance vs Bandwidth and Noise**



## Table of Contents

<b>1 Features</b> .....	1	8.4 Device Functional Modes.....	18
<b>2 Applications</b> .....	1	<b>9 Application and Implementation</b> .....	19
<b>3 Description</b> .....	1	9.1 Application Information.....	19
<b>4 Revision History</b> .....	2	9.2 Typical Application.....	19
<b>5 Device Comparison Table</b> .....	3	<b>10 Power Supply Recommendations</b> .....	23
<b>6 Pin Configuration and Functions</b> .....	3	<b>11 Layout</b> .....	24
Pin Functions.....	3	11.1 Layout Guidelines.....	24
<b>7 Specifications</b> .....	4	11.2 Layout Example.....	24
7.1 Absolute Maximum Ratings.....	4	<b>12 Device and Documentation Support</b> .....	25
7.2 ESD Ratings.....	4	12.1 Device Support.....	25
7.3 Recommended Operating Conditions.....	4	12.2 Documentation Support.....	25
7.4 Thermal Information.....	4	12.3 Receiving Notification of Documentation Updates.....	25
7.5 Electrical Characteristics.....	5	12.4 Support Resources.....	25
7.6 Typical Characteristics.....	7	12.5 Trademarks.....	25
7.7 Typical Characteristics (continued).....	11	12.6 Electrostatic Discharge Caution.....	25
<b>8 Detailed Description</b> .....	14	12.7 Glossary.....	25
8.1 Overview.....	14	<b>13 Mechanical, Packaging, and Orderable Information</b> .....	25
8.2 Functional Block Diagram.....	14		
8.3 Feature Description.....	15		

## 4 Revision History

DATE	REVISION	NOTES
October 2020	*	Initial Release

## 5 Device Comparison Table

DEVICE	INPUT TYPE	MINIMUM STABLE GAIN	VOLTAGE NOISE (nV/ $\sqrt{\text{Hz}}$ )	INPUT CAPACITANCE (pF)	GAIN BANDWIDTH (GHz)
OPA856	Bipolar	1 V/V	0.9	1.1	1.1
OPA855	Bipolar	7 V/V	0.98	0.8	8
OPA858	CMOS	7 V/V	2.5	0.8	5.5
OPA859	CMOS	1 V/V	3.3	0.8	0.9

## 6 Pin Configuration and Functions

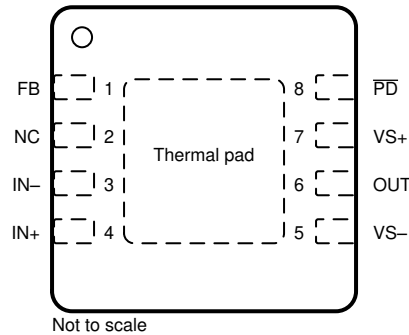

**Figure 6-1. DSG Package  
8-Pin WSON with Exposed Thermal Pad  
Top View**

### Pin Functions

PIN		I/O	DESCRIPTION
NAME	NO.		
FB	1	I	Feedback connection to output of amplifier
IN-	3	I	Inverting input
IN+	4	I	Noninverting input
NC	2	—	Do not connect.
OUT	6	O	Amplifier output
PD	8	I	Power down connection. $\overline{\text{PD}}$ = logic low = power off mode; $\text{PD}$ = logic high = normal operation.
VS-	5	—	Negative voltage supply
VS+	7	—	Positive voltage supply
Thermal pad		—	Connect the thermal pad to VS-.

## 7 Specifications

### 7.1 Absolute Maximum Ratings

over operating free-air temperature range (unless otherwise noted)<sup>(1)</sup>

		MIN	MAX	UNIT
$V_S$	Total supply voltage ( $V_{S+} - V_{S-}$ )		5.5	V
$V_{IN+}, V_{IN-}$	Input voltage	$(V_{S-}) - 0.5$	$(V_{S+}) + 0.5$	V
$V_{ID}$	Differential input voltage		1	V
$V_{OUT}$	Output voltage	$(V_{S-}) - 0.5$	$(V_{S+}) + 0.5$	V
$I_{IN}$	Continuous input current		±10	mA
$I_{OUT}$	Continuous output current <sup>(2)</sup>		±100	mA
$T_J$	Junction temperature		150	°C
$T_A$	Operating free-air temperature	-40	125	°C
$T_{stg}$	Storage temperature	-65	150	°C

(1) Stresses beyond those listed under *Absolute Maximum Rating* may cause permanent damage to the device. These are stress ratings only, which do not imply functional operation of the device at these or any other conditions beyond those indicated under *Recommended Operating Condition*. Exposure to absolute-maximum-rated conditions for extended periods may affect device reliability.

(2) Long-term continuous output current for electromigration limits.

### 7.2 ESD Ratings

			VALUE	UNIT
$V_{(ESD)}$	Electrostatic discharge	Human body model (HBM), per ANSI/ESDA/ JEDEC JS-001, all pins <sup>(1)</sup>	±1500	V
		Charged device model (CDM), per JEDEC specification JS-002, all pins <sup>(2)</sup>	±1500	

(1) JEDEC document JEP155 states that 500-V HBM allows safe manufacturing with a standard ESD control process.

(2) JEDEC document JEP157 states that 250-V CDM allows safe manufacturing with a standard ESD control process.

### 7.3 Recommended Operating Conditions

over operating free-air temperature range (unless otherwise noted)

		MIN	NOM	MAX	UNIT
$V_S$	Total supply voltage ( $V_{S+} - V_{S-}$ )	3.3	5	5.25	V
$T_A$	Operating free-air temperature	-40		125	°C

### 7.4 Thermal Information

THERMAL METRIC <sup>(1)</sup>		OPA856	UNIT
		DSG (WSON)	
		8 PINS	
$R_{\theta JA}$	Junction-to-ambient thermal resistance	80.1	°C/W
$R_{\theta JC(top)}$	Junction-to-case (top) thermal resistance	100	°C/W
$R_{\theta JB}$	Junction-to-board thermal resistance	45	°C/W
$\Psi_{JT}$	Junction-to-top characterization parameter	6.8	°C/W
$\Psi_{JB}$	Junction-to-board characterization parameter	45.2	°C/W
$R_{\theta JC(bot)}$	Junction-to-case (bottom) thermal resistance	22.7	°C/W

(1) For more information about traditional and new thermal metrics, see the [Semiconductor and IC Package Thermal Metrics](#) application report.

## 7.5 Electrical Characteristics

at  $V_{S+} = 5\text{ V}$ ,  $V_{S-} = 0\text{ V}$ ,  $G = 1\text{ V/V}$ ,  $R_F = 0\ \Omega$ , input common-mode biased at midsupply,  $R_L = 200\ \Omega$ , output load is referenced to midsupply, and  $T_A = 25^\circ\text{C}$  (unless otherwise noted)

PARAMETER		TEST CONDITIONS	MIN	TYP	MAX	UNIT
<b>AC PERFORMANCE</b>						
SSBW	Small-signal bandwidth	$V_{OUT} = 100\text{ mV}_{PP}$		1.1		GHz
LSBW	Large-signal bandwidth	$V_{OUT} = 2\text{ V}_{PP}$		110		MHz
GBWP	Gain-bandwidth product			1.08		GHz
	Bandwidth for 0.1-dB flatness	$V_{OUT} = 100\text{ mV}_{PP}$		175		MHz
SR	Slew rate (10%-90%)	$V_{OUT} = 2\text{-V step}$		350		V/ $\mu\text{s}$
$t_r$	Rise time	$V_{OUT} = 100\text{-mV step}$		0.75		ns
$t_f$	Fall time	$V_{OUT} = 100\text{-mV step}$		0.75		ns
	Settling time to 0.1%	$V_{OUT} = 2\text{-V step}$		7		ns
HD2	Second-order harmonic distortion	$f = 10\text{ MHz}$ , $V_{OUT} = 2\text{ V}_{PP}$		85		dBc
		$f = 50\text{ MHz}$ , $V_{OUT} = 2\text{ V}_{PP}$		50		
HD3	Third-order harmonic distortion	$f = 10\text{ MHz}$ , $V_{OUT} = 2\text{ V}_{PP}$		95		dBc
		$f = 50\text{ MHz}$ , $V_{OUT} = 2\text{ V}_{PP}$		45		
$e_n$	Input-referred voltage noise	$f = 1\text{ MHz}$		0.9		nV/ $\sqrt{\text{Hz}}$
$e_i$	Input-referred current noise	$f = 1\text{ MHz}$		2.5		pA/ $\sqrt{\text{Hz}}$
$z_O$	Closed-loop output impedance	$f = 1\text{ MHz}$		0.15		$\Omega$
<b>DC PERFORMANCE</b>						
$A_{OL}$	Open-loop voltage gain		70	76		dB
$V_{OS}$	Input offset voltage	$T_A = 25^\circ\text{C}$	-1.5	$\pm 0.2$	1.5	mV
$\Delta V_{OS}/\Delta T$	Input offset voltage drift	$T_A = -40^\circ\text{C}$ to $125^\circ\text{C}$		0.7		$\mu\text{V}/^\circ\text{C}$
$I_B$	Input bias current <sup>(1)</sup>	$T_A = 25^\circ\text{C}$	-20	-15	-5	$\mu\text{A}$
$\Delta I_B/\Delta T$	Input bias current drift	$T_A = -40^\circ\text{C}$ to $+125^\circ\text{C}$		-0.1		$\mu\text{A}/^\circ\text{C}$
$I_{BOS}$	Input offset current	$T_A = 25^\circ\text{C}$	-1	$\pm 0.1$	1	$\mu\text{A}$
$\Delta I_{BOS}/\Delta T$	Input offset current drift	$T_A = -40^\circ\text{C}$ to $+125^\circ\text{C}$		0.75		nA/ $^\circ\text{C}$
CMRR	Common-mode rejection ratio	$V_{CM} = \pm 0.5\text{ V}$ referred to midsupply	90	106		dB
<b>INPUT</b>						
$C_{CM}$	Common-mode input capacitance			0.4		pF
$C_{DIFF}$	Differential input capacitance			0.7		pF
$V_{IH}$	Common-mode input range (high)	CMRR > 80 dB, $V_{S+} = 3.3\text{ V}$	2.7	2.9		V
$V_{IL}$	Common-mode input range (low)	CMRR > 80 dB, $V_{S+} = 3.3\text{ V}$		1.1	1.3	V
$V_{IH}$	Common-mode input range (high)	CMRR > 80 dB	4.4	4.6		V
$V_{IH}$	Common-mode input range (high)	$T_A = -40^\circ\text{C}$ to $+125^\circ\text{C}$ , CMRR > 80 dB		4.3		V
$V_{IL}$	Common-mode input range (low)	CMRR > 80 dB		1.1	1.3	V
$V_{IL}$	Common-mode input range (low)	$T_A = -40^\circ\text{C}$ to $+125^\circ\text{C}$ , CMRR > 80 dB		1.3		V

## 7.5 Electrical Characteristics (continued)

at  $V_{S+} = 5\text{ V}$ ,  $V_{S-} = 0\text{ V}$ ,  $G = 1\text{ V/V}$ ,  $R_F = 0\ \Omega$ , input common-mode biased at midsupply,  $R_L = 200\ \Omega$ , output load is referenced to midsupply, and  $T_A = 25^\circ\text{C}$  (unless otherwise noted)

PARAMETER		TEST CONDITIONS	MIN	TYP	MAX	UNIT
<b>OUTPUT</b>						
$V_{OH}$	Output voltage (high) <sup>(2)</sup>	$T_A = 25^\circ\text{C}$ , $V_{S+} = 3.3\text{ V}$	2.35	2.4		V
$V_{OH}$	Output voltage (high) <sup>(2)</sup>	$T_A = 25^\circ\text{C}$	3.95	4.1		V
		$T_A = -40^\circ\text{C}$ to $+125^\circ\text{C}$		4		
$V_{OL}$	Output voltage (low) <sup>(2)</sup>	$T_A = 25^\circ\text{C}$ , $V_{S+} = 3.3\text{ V}$		1.05	1.15	V
$V_{OL}$	Output voltage (low) <sup>(2)</sup>	$T_A = 25^\circ\text{C}$		1.05	1.15	V
		$T_A = -40^\circ\text{C}$ to $+125^\circ\text{C}$		1.1		
$I_{O\_LIN}$	Linear output drive (sink and source)	$R_L = 10\ \Omega$ , $A_{OL} > 60\text{ dB}$	65	80		mA
		$T_A = -40^\circ\text{C}$ to $+125^\circ\text{C}$ , $R_L = 10\ \Omega$ , $A_{OL} > 60\text{ dB}$		65		
$I_{SC}$	Output short-circuit current		85	105		mA
<b>POWER SUPPLY</b>						
$I_Q$	Quiescent current		15.4	17.2	19.5	mA
		$T_A = -40^\circ\text{C}$		15.5		
		$T_A = 125^\circ\text{C}$		19.5		
PSRR+	Positive power-supply rejection ratio		80	86		dB
PSRR-	Negative power-supply rejection ratio		70	80		
<b>POWER DOWN</b>						
	Disable voltage threshold	Amplifier OFF below this voltage	0.65	1		V
	Enable voltage threshold	Amplifier ON above this voltage		1.5	1.8	V
	Power-down quiescent current			70	85	$\mu\text{A}$
	$\overline{\text{PD}}$ bias current			70	85	$\mu\text{A}$
	Turnon time delay	Time to $V_{OUT} = 90\%$ of final value		15		ns
	Turnoff time delay			250		ns

(1) Current flowing into the input pin is considered negative.

(2) Amplifier output saturated.

## 7.6 Typical Characteristics

at  $V_{S+} = +2.5\text{ V}$ ,  $V_{S-} = -2.5\text{ V}$ ,  $R_F = 0\ \Omega$ , Gain = 1 V/V, input common-mode biased at midsupply,  $R_L = 200\ \Omega$ , output load referenced to midsupply, and  $T_A = 25^\circ\text{C}$  (unless otherwise noted)

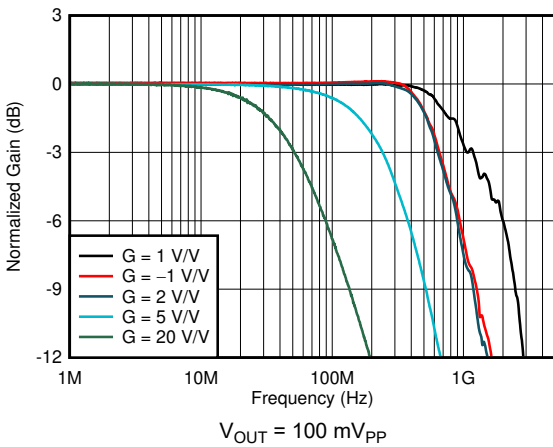

Figure 7-1. Small-Signal Response vs Gain

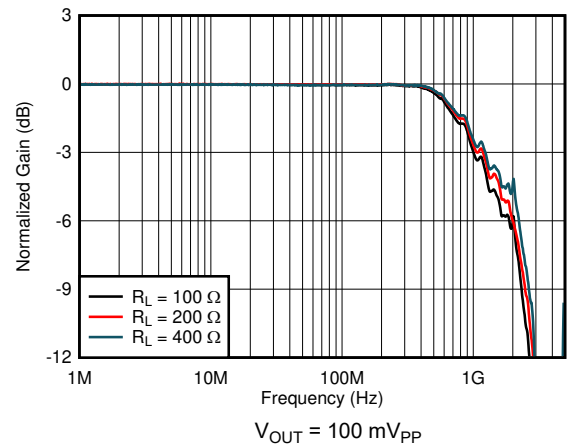

Figure 7-2. Small-Signal Response vs Output Load

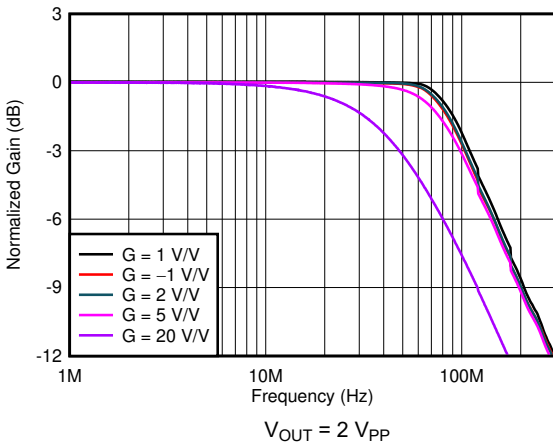

Figure 7-3. Large-Signal Response vs Gain

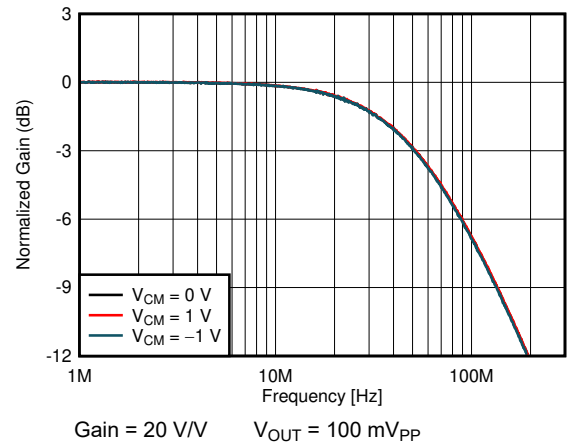

Figure 7-4. Gain Bandwidth vs Common-Mode

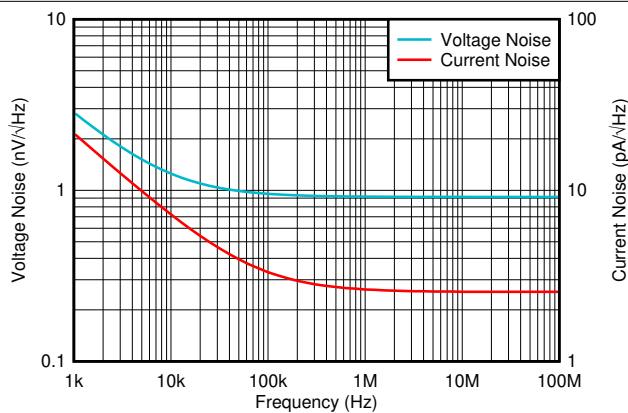

Figure 7-5. Voltage and Current Noise Density

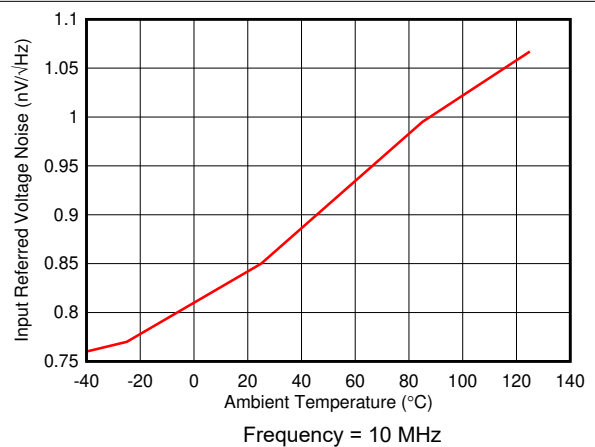

Figure 7-6. Voltage Noise vs Temperature

### 7.6 Typical Characteristics (continued)

at  $V_{S+} = +2.5\text{ V}$ ,  $V_{S-} = -2.5\text{ V}$ ,  $R_F = 0\ \Omega$ , Gain = 1 V/V, input common-mode biased at midsupply,  $R_L = 200\ \Omega$ , output load referenced to midsupply, and  $T_A = 25^\circ\text{C}$  (unless otherwise noted)

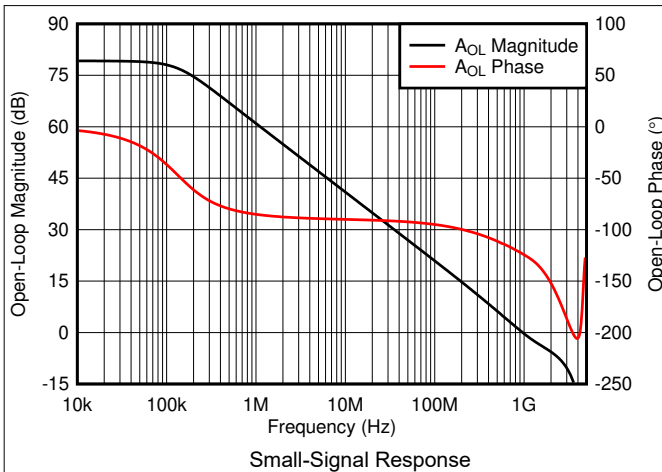

Figure 7-7. Open-Loop Magnitude and Phase

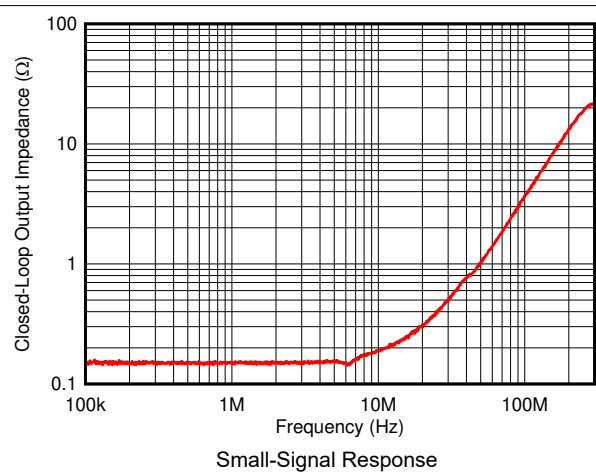

Figure 7-8. Closed Loop Output Impedance

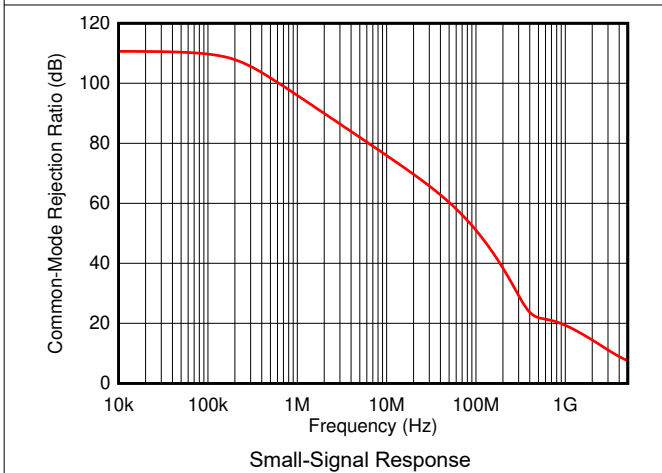

Figure 7-9. Common-Mode Rejection Ratio

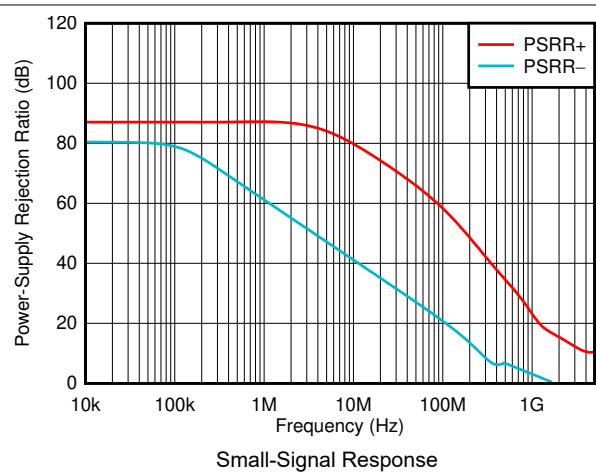

Figure 7-10. Power Supply Rejection Ratio

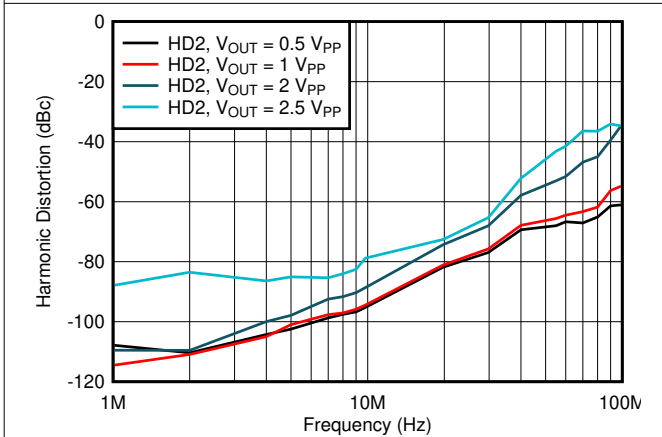

Figure 7-11. Harmonic Distortion (HD2) vs Output Swing

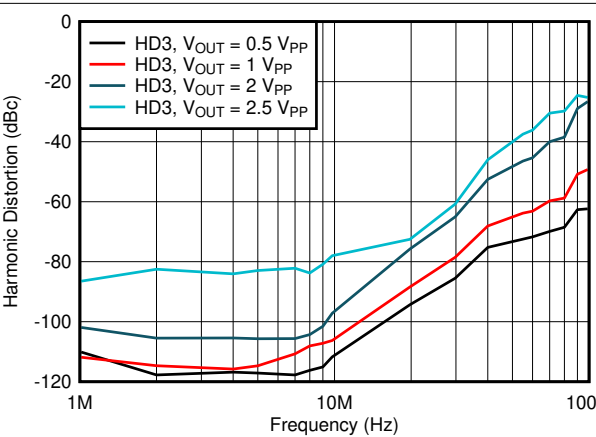

Figure 7-12. Harmonic Distortion (HD3) vs Output Swing



## 7.6 Typical Characteristics (continued)

at  $V_{S+} = +2.5\text{ V}$ ,  $V_{S-} = -2.5\text{ V}$ ,  $R_F = 0\ \Omega$ , Gain = 1 V/V, input common-mode biased at midsupply,  $R_L = 200\ \Omega$ , output load referenced to midsupply, and  $T_A = 25^\circ\text{C}$  (unless otherwise noted)

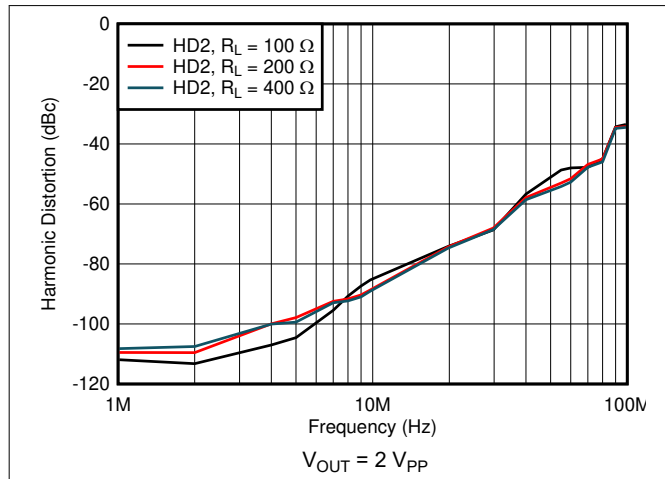

Figure 7-13. Harmonic Distortion (HD2) vs Load

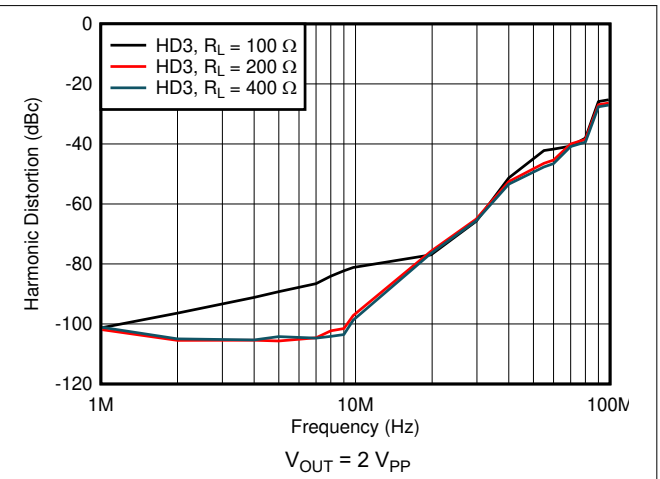

Figure 7-14. Harmonic Distortion (HD3) vs Load

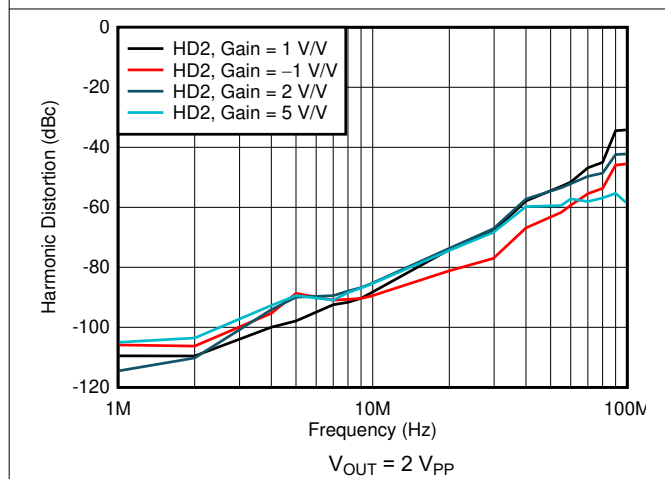

Figure 7-15. Harmonic Distortion (HD2) vs Gain

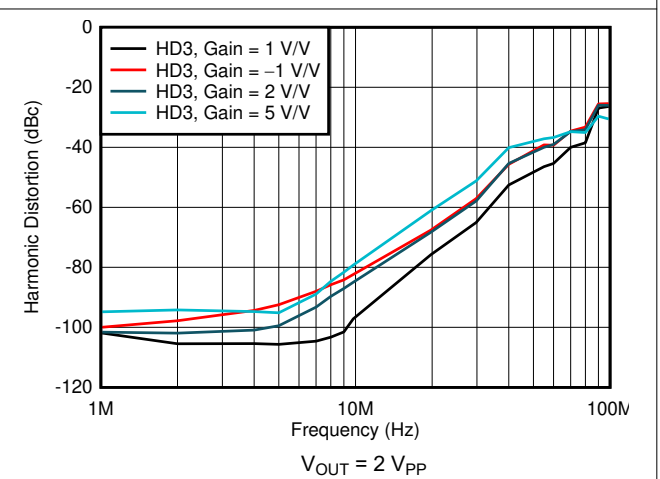

Figure 7-16. Harmonic Distortion (HD3) vs Gain

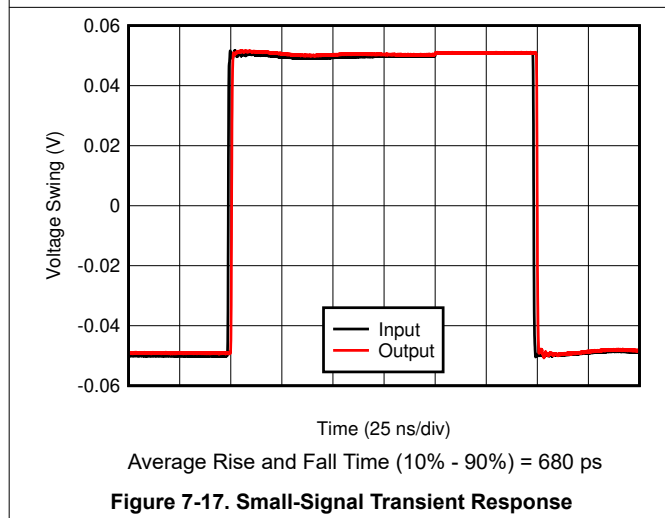

Figure 7-17. Small-Signal Transient Response

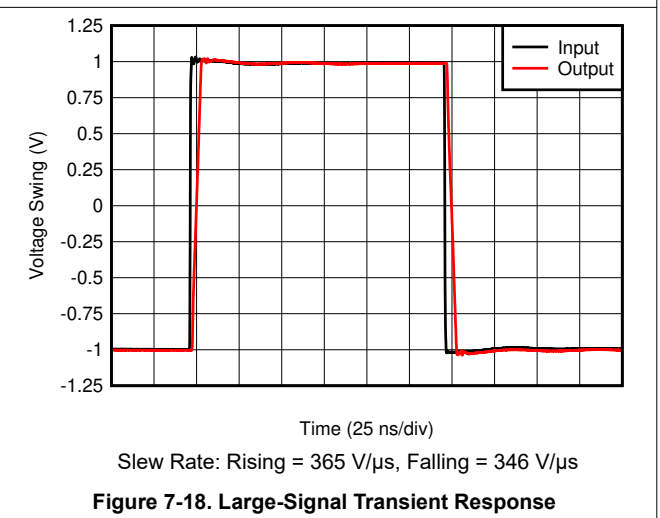

Figure 7-18. Large-Signal Transient Response

### 7.6 Typical Characteristics (continued)

at  $V_{S+} = +2.5\text{ V}$ ,  $V_{S-} = -2.5\text{ V}$ ,  $R_F = 0\ \Omega$ , Gain = 1 V/V, input common-mode biased at midsupply,  $R_L = 200\ \Omega$ , output load referenced to midsupply, and  $T_A = 25^\circ\text{C}$  (unless otherwise noted)

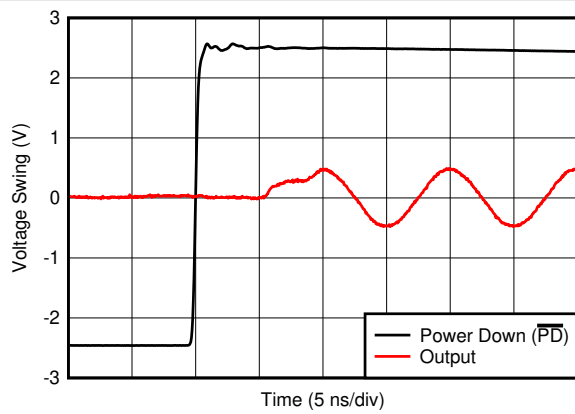

Figure 7-19. Turnon Transient Response

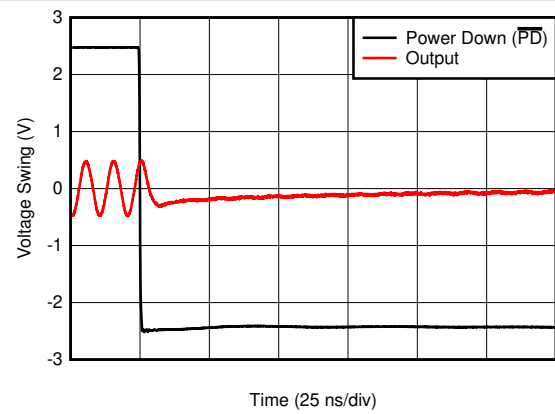
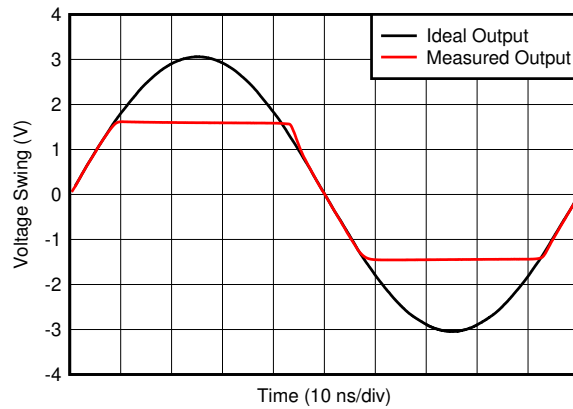

Figure 7-20. Turnoff Transient Response



Gain = 5 V/V,  $R_F = 453\ \Omega$ ,  $V_{IN} = 1.25\text{ V}_{PP}$ , 2x Output Overdrive

Figure 7-21. Output Overload Response

### 7.7 Typical Characteristics (continued)

at  $V_{S+} = +2.5\text{ V}$ ,  $V_{S-} = -2.5\text{ V}$ ,  $R_F = 0\ \Omega$ , Gain = 1 V/V, input common-mode biased at midsupply,  $R_L = 200\ \Omega$ , output load referenced to midsupply, and  $T_A = 25^\circ\text{C}$  (unless otherwise noted)

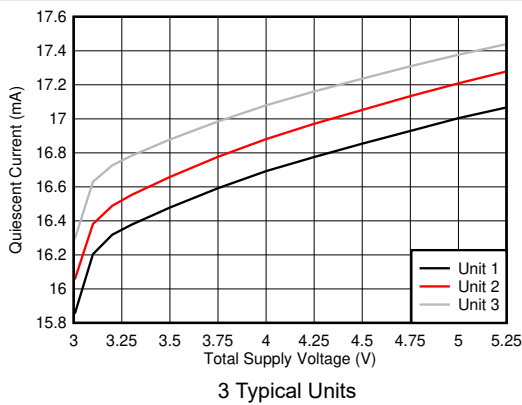

**Figure 7-22. Quiescent Current vs Supply Voltage**

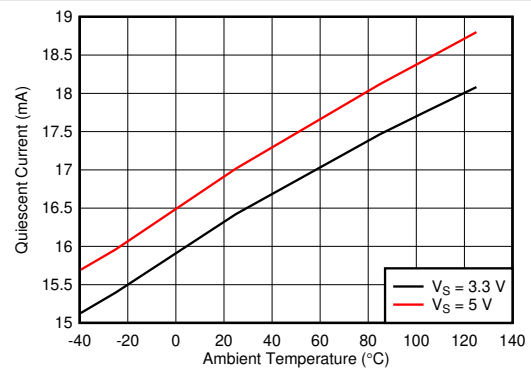

**Figure 7-23. Quiescent Current vs Ambient Temperature**

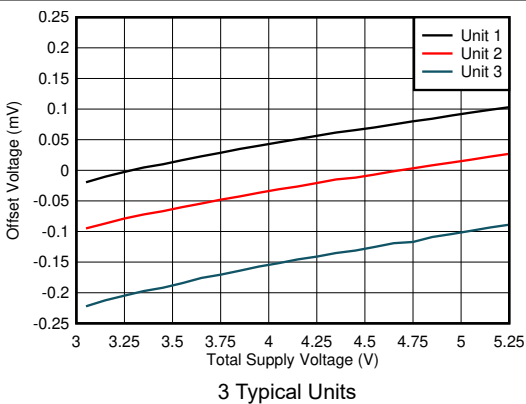

**Figure 7-24. Offset Voltage vs Supply Voltage**

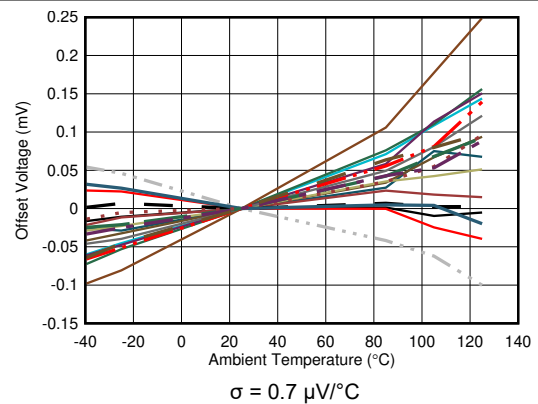

**Figure 7-25. Offset Voltage vs Ambient Temperature**

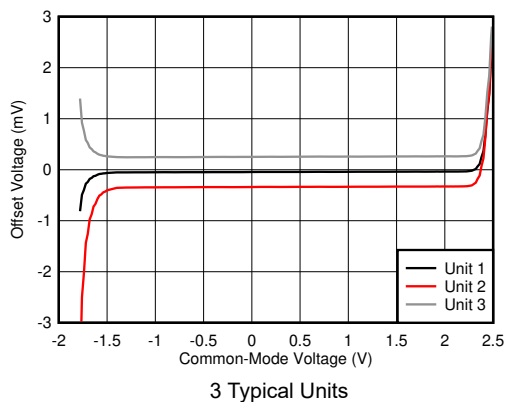

**Figure 7-26. Offset Voltage vs Input Common-Mode Voltage**

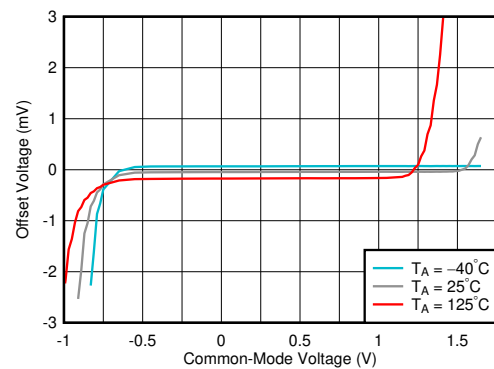

**Figure 7-27. Offset Voltage vs Input Common-Mode Voltage vs Ambient Temperature**

### 7.7 Typical Characteristics (continued) (continued)

at  $V_{S+} = +2.5\text{ V}$ ,  $V_{S-} = -2.5\text{ V}$ ,  $R_F = 0\ \Omega$ , Gain = 1 V/V, input common-mode biased at midsupply,  $R_L = 200\ \Omega$ , output load referenced to midsupply, and  $T_A = 25^\circ\text{C}$  (unless otherwise noted)

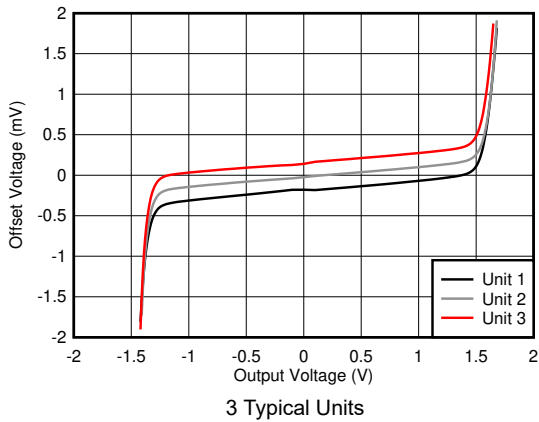

Figure 7-28. Offset Voltage vs Output Swing

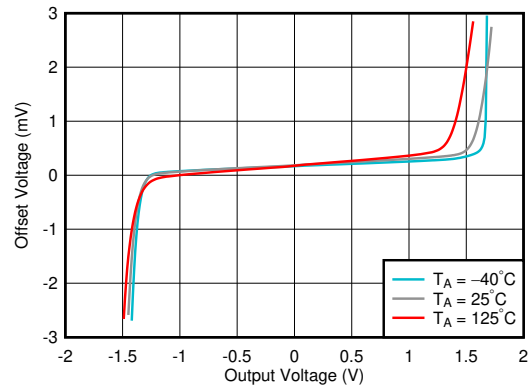

Figure 7-29. Offset Voltage vs Output Swing vs Ambient Temperature

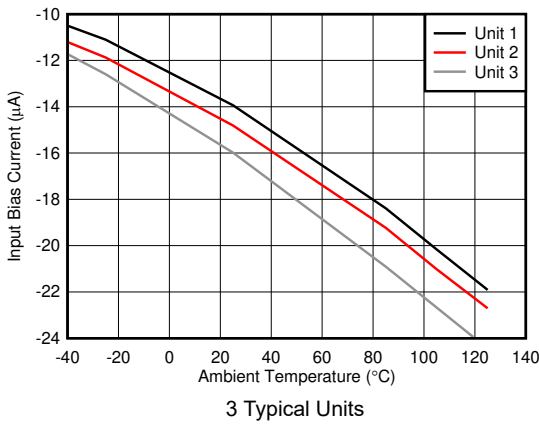

Figure 7-30. Input Bias Current vs Ambient Temperature

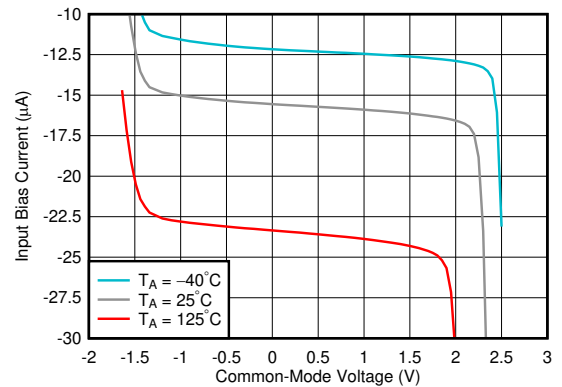

Figure 7-31. Input Bias Current vs Input Common-Mode Voltage

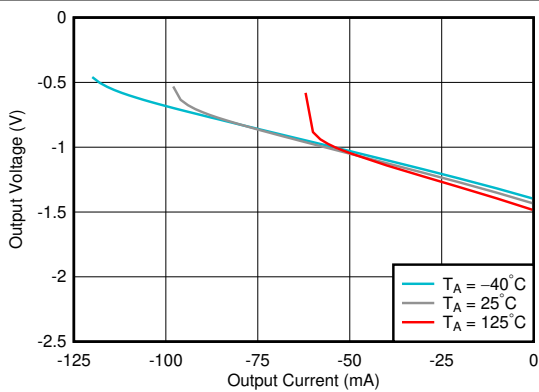

Figure 7-32. Output Swing vs Sinking Current

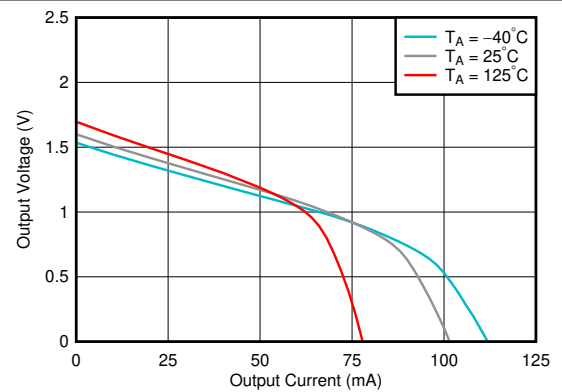
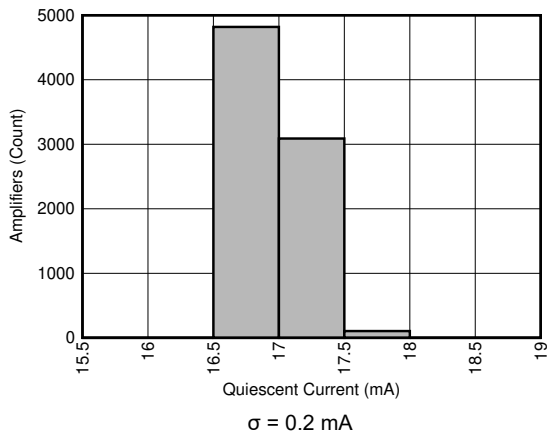

Figure 7-33. Output Swing vs Sourcing Current

### 7.7 Typical Characteristics (continued) (continued)

at  $V_{S+} = +2.5\text{ V}$ ,  $V_{S-} = -2.5\text{ V}$ ,  $R_F = 0\ \Omega$ , Gain = 1 V/V, input common-mode biased at midsupply,  $R_L = 200\ \Omega$ , output load referenced to midsupply, and  $T_A = 25^\circ\text{C}$  (unless otherwise noted)



**Figure 7-34. Quiescent Current Distribution**

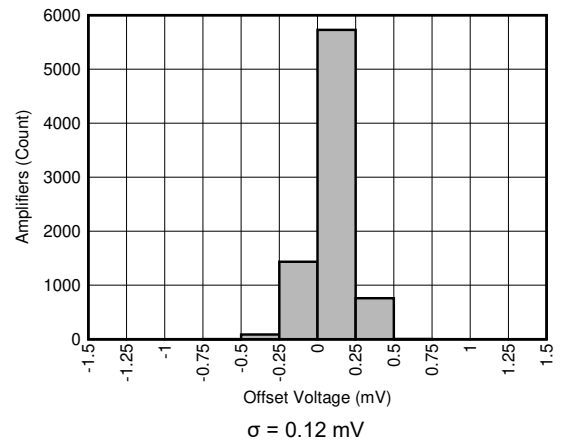

**Figure 7-35. Offset Voltage Distribution**

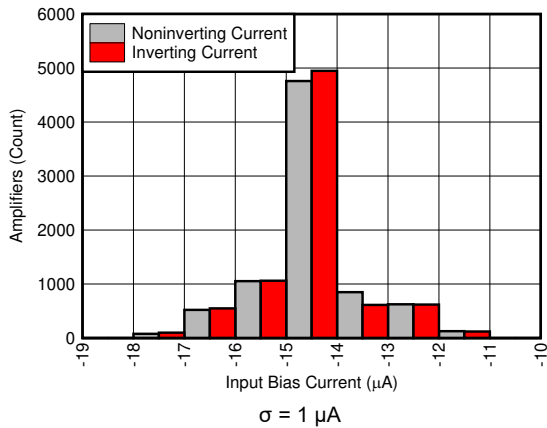

**Figure 7-36. Input Bias Current Distribution**

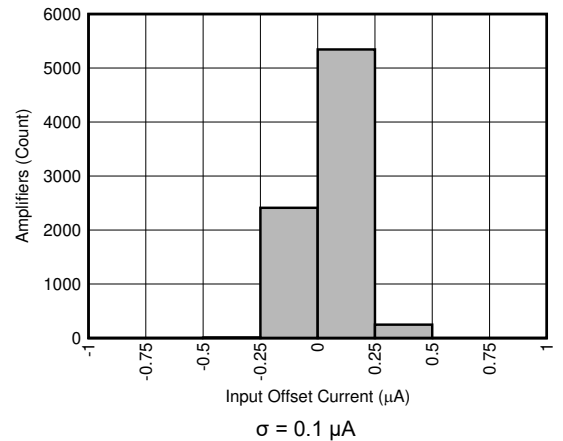

**Figure 7-37. Input Offset Current Distribution**

## 8 Detailed Description

### 8.1 Overview

The ultra-wide, 1.1-GHz gain bandwidth product (GBWP) of the OPA856, combined with the broadband voltage noise of  $0.9 \text{ nV}/\sqrt{\text{Hz}}$ , produces a viable amplifier for wideband transimpedance applications, high-speed data acquisition systems, and applications with weak signal inputs that require low-noise and high-gain front ends. The OPA856 combines multiple features to optimize dynamic performance. In addition to the wide, small-signal bandwidth, the OPA856 has 110 MHz of large-signal bandwidth ( $V_{\text{OUT}} = 2 V_{\text{PP}}$ ), and a slew rate of  $350 \text{ V}/\mu\text{s}$ .

The OPA856 is offered in a 2-mm × 2-mm, 8-pin WSON package that features a feedback (FB) pin for a simple feedback network connection between the amplifiers output and inverting input. Excess capacitance on an amplifiers input pin can reduce phase margin causing instability. This problem is exacerbated in the case of very wideband amplifiers like the OPA856. To reduce the effects of stray capacitance on the input node, the OPA856 pinout features an isolation pin (NC) between the feedback and inverting input pins that increases the physical spacing between them thereby reducing parasitic coupling at high frequencies. The OPA856 also features a very low capacitance input stage with only 1.1-pF of total input capacitance.

### 8.2 Functional Block Diagram

The OPA856 is a classic voltage feedback operational amplifier (op amp) with two high-impedance inputs and a low-impedance output. Standard application circuits are supported, like the two basic options shown in [Figure 8-1](#) and [Figure 8-2](#). The resistor on the noninverting pin is used for bias current cancellation to minimize the output offset voltage. In a noninverting configuration the additional resistors on the noninverting pin add noise to the system so if SNR is critical, the resistor can be eliminated. In an inverting configuration the noninverting node is typically connected to a DC voltage, so the high-frequency noise contribution from the bias cancellation resistor can be bypassed by adding a large 1- $\mu\text{F}$  capacitor in parallel to the resistor to shunt the noise. The DC operating point for each configuration is level-shifted by the reference voltage ( $V_{\text{REF}}$ ), which is typically set to midsupply in single-supply operation.  $V_{\text{REF}}$  is typically connected to ground in split-supply applications.

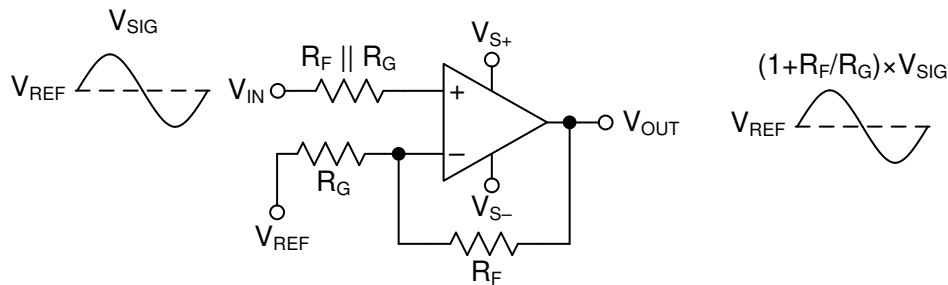

**Figure 8-1. Noninverting Amplifier**

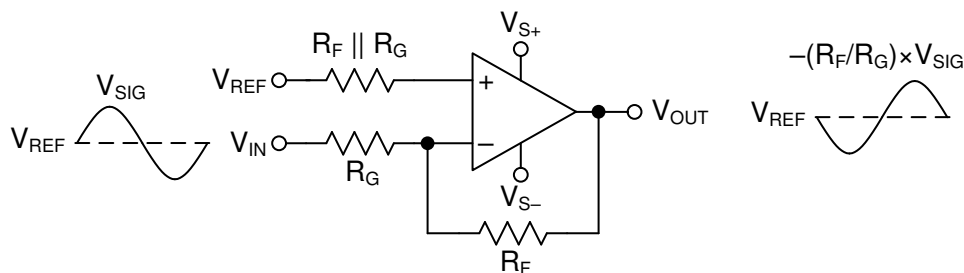
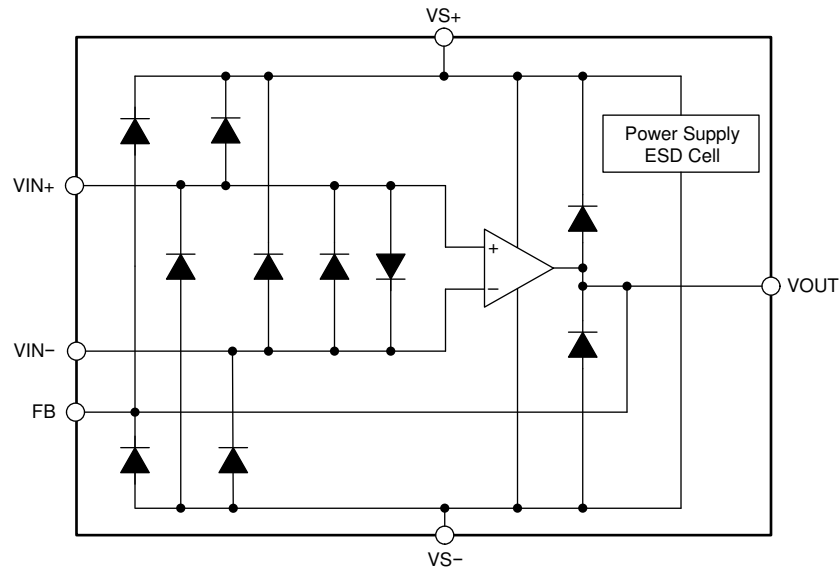

**Figure 8-2. Inverting Amplifier**

## 8.3 Feature Description

### 8.3.1 Input and ESD Protection

The OPA856 is fabricated on a low-voltage, high-speed, BiCMOS process. The internal, junction breakdown voltages are low for these small geometry devices, and as a result, all device pins are protected with internal ESD protection diodes to the power supplies as Figure 8-3 shows. There are two antiparallel diodes between the inputs of the amplifier that clamp the inputs during an overrange or fault condition.

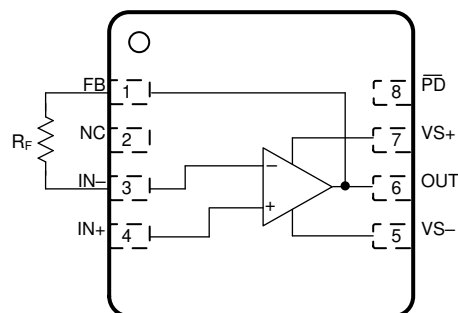

**Figure 8-3. Internal ESD Structure**

### 8.3.2 Feedback Pin

The OPA856 pin layout is optimized to minimize parasitic inductance and capacitance, which is a critical care about in high-speed analog design. The FB pin (pin 1) is internally connected to the output of the amplifier. The FB pin is separated from the inverting input of the amplifier (pin 3) by a no connect (NC) pin (pin 2). The NC pin must be left floating. There are two advantages to this pin layout:

1. A feedback resistor ( $R_F$ ) can connect between the FB and IN $-$  pin on the same side of the package (see Figure 8-4) rather than going around the package.
2. The isolation created by the NC pin minimizes the capacitive coupling between the FB and IN $-$  pins by increasing the physical separation between the pins.



**Figure 8-4.  $R_F$  Connection Between FB and IN $-$  Pins**

### 8.3.3 Wide Gain-Bandwidth Product

Figure 7-7 shows the open-loop magnitude and phase response of the OPA856. Calculate the gain bandwidth product of any op amp by determining the frequency at which the  $A_{OL}$  is 40 dB and multiplying that frequency by a factor of 100. The open-loop response shows the OPA856 to have approximately  $57^\circ$  of phase-margin when configured as a unity-gain buffer.

Figure 8-5 shows the open-loop magnitude ( $A_{OL}$ ) of the OPA856 as a function of temperature. The results show minimal variation over the entire temperature range. Semiconductor process variation is the naturally occurring variation in the attributes of a transistor (Early-voltage,  $\beta$ , channel-length, and width) and other passive elements (resistors and capacitors) when fabricated into an integrated circuit. The process variation can occur across devices on a single wafer or across devices over multiple wafer lots over time. Typically the variation across a single wafer is tightly controlled. Figure 8-6 shows the  $A_{OL}$  magnitude of the OPA856 as a function of process variation over time. The results show the  $A_{OL}$  curve for the nominal process corner and the variation one standard deviation from the nominal. The simulated results show less than  $5^\circ$  of phase-margin difference within a standard deviation of process variation when the amplifier is configured as a unity-gain buffer.

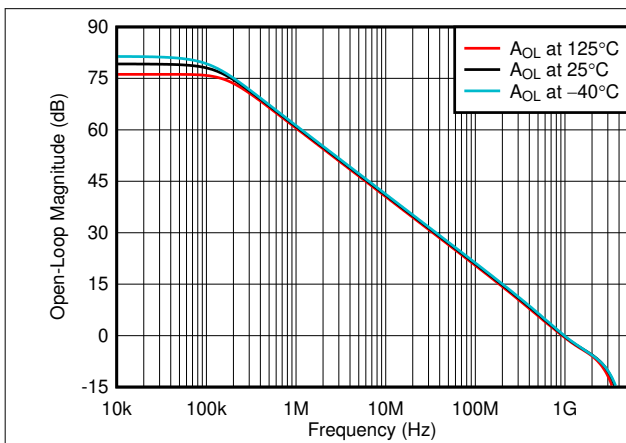

Figure 8-5. Open-Loop Gain vs Temperature

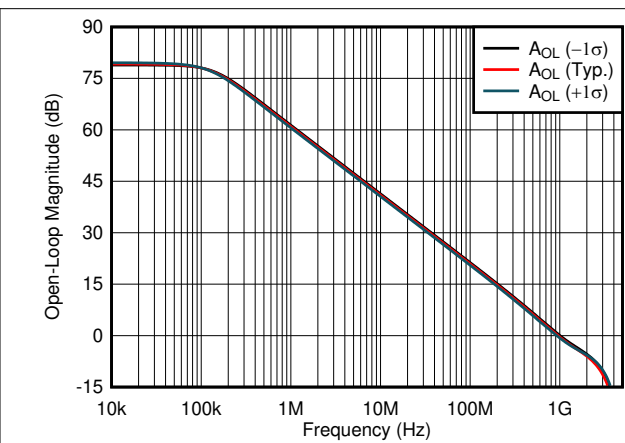

Figure 8-6. Open-Loop Gain vs Process Variation



### 8.3.4 Slew Rate and Output Stage

In addition to wide bandwidth, the OPA856 features a high slew rate of 2750 V/ $\mu$ s. The slew rate is a critical parameter in high-speed pulse applications with narrow sub-10-ns pulses, such as optical time-domain reflectometry (OTDR) and LIDAR. The high slew rate of the OPA856 implies that the device accurately reproduces a 2-V, sub-ns pulse edge, as seen in [Figure 7-18](#). The wide bandwidth and slew rate of the OPA856 make it an excellent amplifier for high-speed signal-chain front ends.

[Figure 8-7](#) shows the open-loop output impedance of the OPA856 as a function of frequency. To achieve high slew rates and low output impedance across frequency, the output swing of the OPA856 is limited to approximately 3 V. The OPA856 is typically used in conjunction with high-speed pipeline ADCs and flash ADCs that have limited input ranges. Therefore, the OPA856 output swing range coupled with the class-leading voltage noise specification maximizes the overall dynamic range of the signal chain.

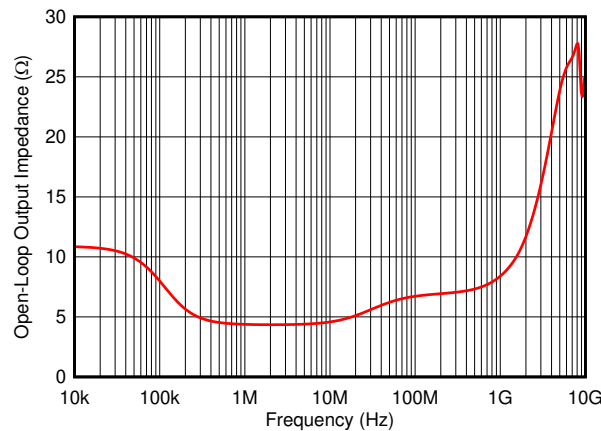

**Figure 8-7. Open-Loop Output Impedance ( $Z_{OL}$ ) vs Frequency**

## 8.4 Device Functional Modes

### 8.4.1 Split-Supply and Single-Supply Operation

The OPA856 can be configured with single-sided supplies or split-supplies as shown in [Figure 10-1](#). Split-supply operation using balanced supplies with the input common-mode set to ground eases lab testing because most signal generators, network analyzers, spectrum analyzers, and other lab equipment typically reference inputs and outputs to ground. In split-supply operation, the thermal pad must be connected to the negative supply.

Newer systems use a single power supply to improve efficiency and reduce the cost of the extra power supply. The OPA856 can be used with a single positive supply (negative supply at ground) with no change in performance if the input common-mode and output swing are biased within the linear operation of the device. In single-supply operation, level shift the DC input and output reference voltages by half the difference between the power supply rails. This configuration maintains the input common-mode and output load reference at midsupply. To eliminate gain errors, the source driving the reference input common-mode voltage must have low output impedance across the frequency range of interest. In this case, the thermal pad must be connected to ground.

### 8.4.2 Power-Down Mode

The OPA856 features a power-down mode to reduce the quiescent current to conserve power. [Figure 7-19](#) and [Figure 7-20](#) show the transient response of the OPA856 as the  $\overline{\text{PD}}$  pin toggles between the disabled and enabled states.

The  $\overline{\text{PD}}$  disable and enable threshold voltages are with reference to the negative supply. If the amplifier is configured with the positive supply at 3.3 V and the negative supply at ground, then the disable and enable threshold voltages are 0.65 V and 1.8 V, respectively. If the amplifier is configured with  $\pm 1.65$  V supplies, then the threshold voltages are at  $-1$  V and 0.15 V. If the amplifier is configured with  $\pm 2.5$  V supplies, then the threshold voltages are at  $-1.85$  V and  $-0.7$  V.

[Figure 8-8](#) shows the switching behavior of a typical amplifier as the  $\overline{\text{PD}}$  pin is swept down from the enabled state to the disabled state. Similarly, [Figure 8-9](#) shows the switching behavior of a typical amplifier as the  $\overline{\text{PD}}$  pin is swept up from the disabled state to the enabled state. The small difference in the switching thresholds between the down sweep and the up sweep is caused by the hysteresis designed into the amplifier to increase immunity to noise on the  $\overline{\text{PD}}$  pin.

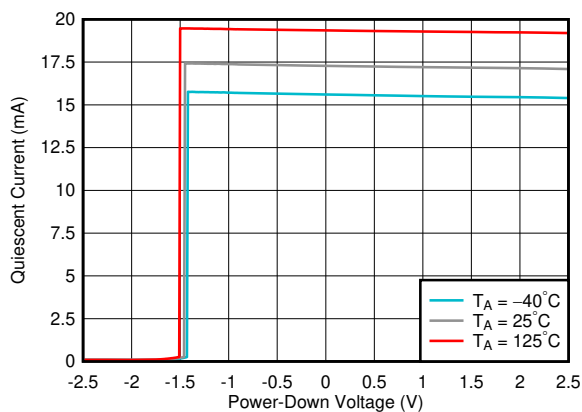

**Figure 8-8. Switching Threshold  
(PD Pin Swept from High to Low)**

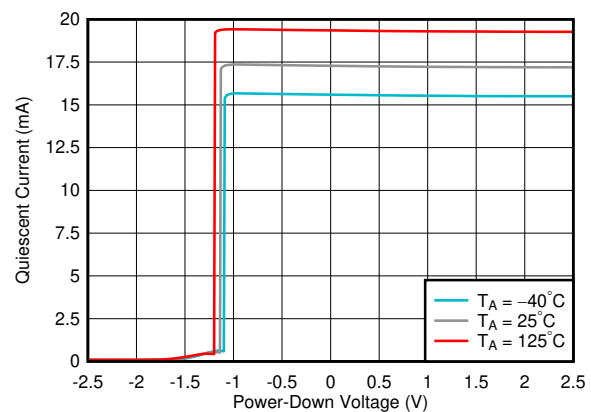

**Figure 8-9. Switching Threshold  
(PD Pin Swept from Low to High)**

Connecting the  $\overline{\text{PD}}$  pin low disables the amplifier and places the output in a high-impedance state. When the amplifier is configured as a noninverting amplifier, the feedback ( $R_F$ ) and gain ( $R_G$ ) resistor network form a parallel load to the output of the amplifier. To protect the input stage of the amplifier, the OPA856 uses internal, back-to-back protection diodes between the inverting and noninverting input pins as [Figure 8-3](#) shows. In the power-down state, if the differential voltage between the input pins of the amplifier exceeds a diode voltage drop, an additional low-impedance path is created between the noninverting input pin and the output pin.

## 9 Application and Implementation

### Note

Information in the following applications sections is not part of the TI component specification, and TI does not warrant its accuracy or completeness. TI's customers are responsible for determining suitability of components for their purposes. Customers should validate and test their design implementation to confirm system functionality.

### 9.1 Application Information

The OPA856 offers over 1 GHz of bandwidth, high slew-rate, low noise, excellent linearity, and is stable for unity gain applications. The low noise and unity gain stability make the OPA856 a great choice for use as a front-end buffer in high-speed data acquisition systems. Additionally the wide bandwidth allows the amplifier to perform excellently in transimpedance applications or in a high-gain active filter configuration.

### 9.2 Typical Application

The high GBWP of the OPA856 makes the device an excellent choice as a transimpedance amplifier while the unity gain stability allows for use of feedback clamping or other unity gain circuitry that would not work for a decompensated amplifier. [Figure 9-1](#) shows the OPA856 configured as a transimpedance amplifier with an option feedback clamping diode connection.

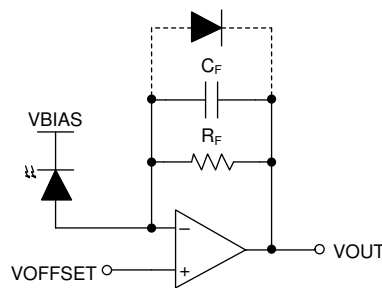

**Figure 9-1. OPA856 Transimpedance Amplifier with Optional Diode Clamping**

#### 9.2.1 Design Requirements

The objective is to design a low noise, wideband optical front-end system using the OPA856

as a transimpedance amplifier. The design requirements are:

- Amplifier supply voltage:  $\pm 2.5$  V
- 1 k $\Omega$  transimpedance gain
- Transimpedance bandwidth > 100 MHz
- Total input capacitance 4 pF (1.1 pF from amplifier)

## 9.2.2 Detailed Design Procedure

The OPA856 meets the growing demand for wideband, low-noise photodiode amplifiers. The closed-loop bandwidth of a transimpedance amplifier is a function of the following:

1. The total input capacitance ( $C_{IN}$ ). This total includes the photodiode capacitance, the input capacitance of the amplifier (common-mode and differential capacitance) and any stray capacitance from the PCB.
2. The op amp gain bandwidth product (GBWP).
3. The transimpedance gain ( $R_F$ ).

Figure 9-1 shows the OPA856 configured as a TIA, with the photodiode reverse biased so that the diode cathode is tied to a positive bias voltage. In this configuration, the diode sources current into the op amp feedback loop so that the output swings in a negative direction relative to the input common-mode ( $V_{OFFSET}$ ) voltage. The feedback resistance ( $R_F$ ) and the input capacitance ( $C_{IN}$ ) form a zero in the noise gain that results in instability if left unchecked. To counteract the effect of the zero, a pole is inserted into the noise gain transfer function by adding the feedback capacitor ( $C_F$ ).

The [Transimpedance Considerations for High-Speed Amplifiers Application Report](#) discusses theories and equations that show how to compensate a transimpedance amplifier for a particular transimpedance gain and input capacitance. The bandwidth and compensation equations from the application report are available in a Microsoft Excel™ calculator. [What You Need To Know About Transimpedance Amplifiers – Part 1](#) provides a link to the calculator. Calculating the expected bandwidth with an approximate input capacitance of 4 pF and a feedback capacitor of 1 pF yields a bandwidth of approximately 200 MHz.

The amplifier was tested in a transimpedance configuration by using a photodiode with an optical fiber input connection. A tunable laser connected through an optical modulator was used to create the modulated optical excitation to the photodiode. Figure 9-2 shows the test setup configuration for the frequency response measurement. The network analyzer's swept frequency output drives the optical modulators electrical input which in turn drives the photodiode. The OPA856 output drives the network analyzer's input.

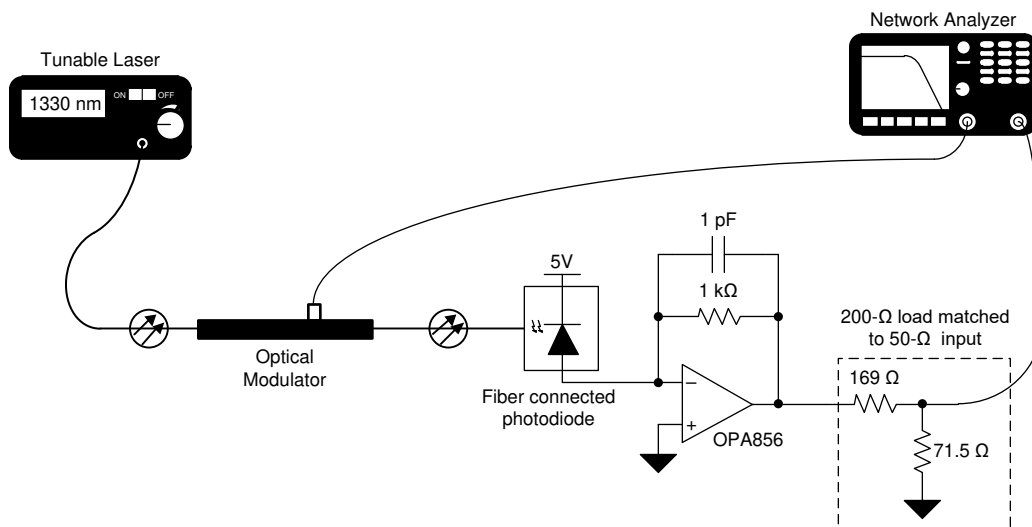

**Figure 9-2. OPA856 Transimpedance Frequency Response Test Setup**

Figure 9-4 shows the frequency response measurements for a small signal and large signal ( $\sim 1$  Vpp) output. The plot contains noticeable noise and variations because the test environment did not have complete capability to accurately manage the thermal drift, perform optical connection integrity analysis, and calibrate the optical path. A more stringently controlled optical environment could achieve more stable results, but was beyond the scope of these measurements. The results in Figure 9-4 correlate well with predicted results of approximately 200 MHz of bandwidth. It is expected that the results would not perfectly match calculated values because it is challenging to perfectly account for all parasitic capacitances that affect the input and feedback capacitance in the transimpedance calculations.

Many transimpedance applications can have unpredicted, large input currents that can cause the amplifier's output to saturate. It is often important to understand how the amplifier will behave when its output is saturated at various levels of overdrive. A typical linear amplifier like the OPA856 can be expected to have an output saturation recovery time that increases as the amount of output overdrive increases. When using a pulse based input signal, the output saturation recovery time effectively extends the duration of the pulse. [Figure 9-3](#) shows the test setup configuration to measure a pulsed optical input to the OPA856. The optical modulator used in the test setup had limited output amplitude capability to create a saturated signal. In order to prevent the modulator from saturating, the OPA856 output was saturated by adjusting VOFFSET close to the the amplifier's output swing limit on the negative rail.

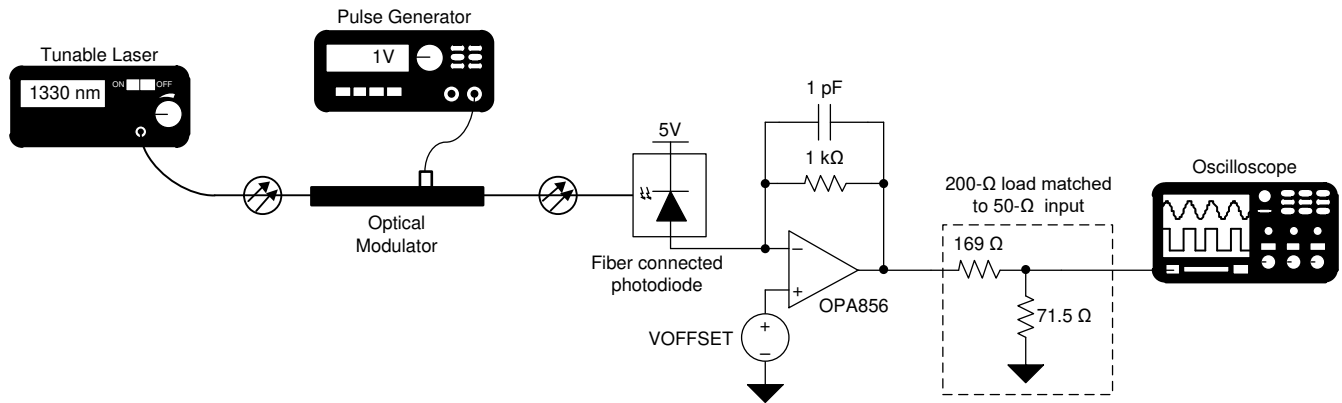

**Figure 9-3. OPA856 Transimpedance Pulse Saturation Extension Test Setup**

[Figure 9-5](#) shows the resulting shifted output pulses labelled by the magnitude of voltage they are overdriving the amplifiers output saturation voltage level ( $V_{OV}$ ). These values only serve as approximations of the overdrive level of the signal because of expected variances from the optical interface setup. [Figure 9-6](#) shows a magnified view of the rising edge of the measured pulse responses in order to better detail the pulse extension created by the signal overdrive. These plots have been scaled and normalized to be easier to read and compare. As expected, [Figure 9-6](#) shows that the pulse duration is extended as the overdrive level increases. The data only captured an overdrive voltage maximum of 640 mV, but it can be expected that larger voltages would extend the pulse further.

### 9.2.3 Application Curves

**Note**

Figure 9-6 output voltages are scaled for visual comparison purposes and are not the actual measured values. See Figure 9-5 for actual measured values.

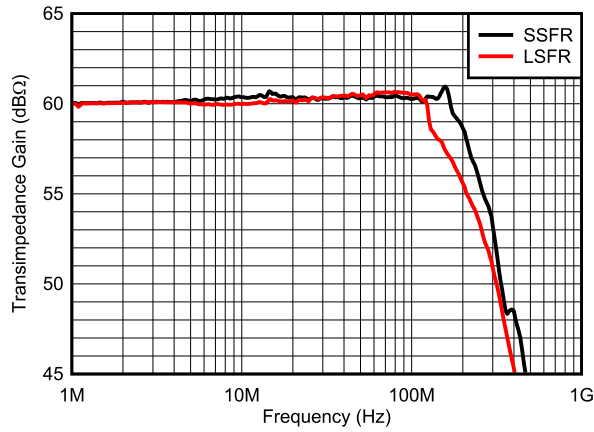

**Figure 9-4. Transimpedance Frequency Response**

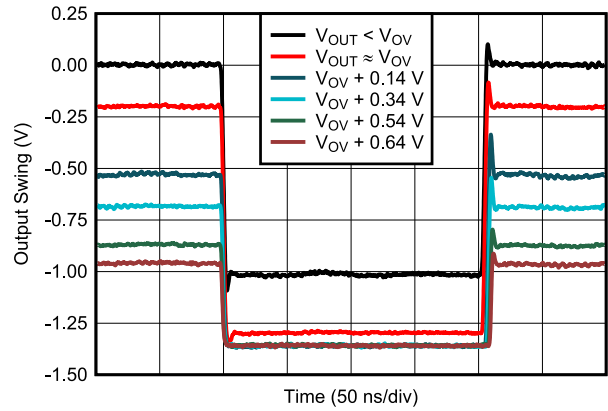

**Figure 9-5. Transimpedance Pulse Response**

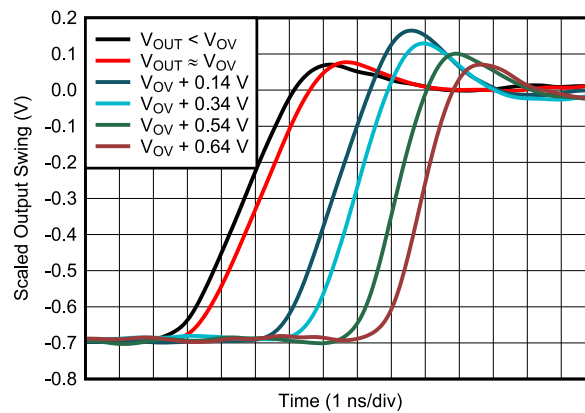
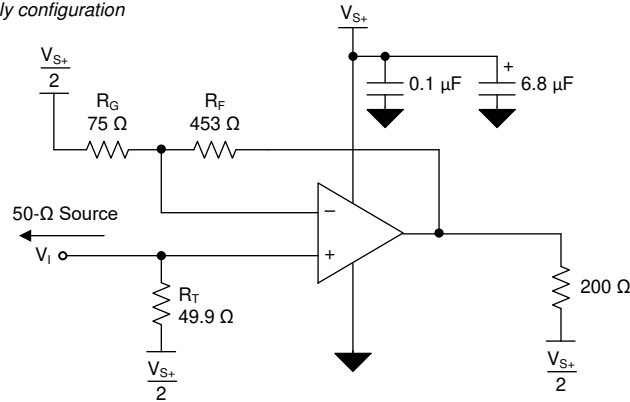

**Figure 9-6. Transimpedance Pulse Response Magnified and Scaled**

## 10 Power Supply Recommendations

The OPA856 operates on supplies from 3.3 V to 5.25 V. The OPA856 operates on single-sided supplies, split and balanced bipolar supplies, and unbalanced bipolar supplies. Because the OPA856 does not feature rail-to-rail inputs or outputs, the input common-mode and output swing ranges are limited at 3.3-V supplies.

a) Single supply configuration



b) Split supply configuration

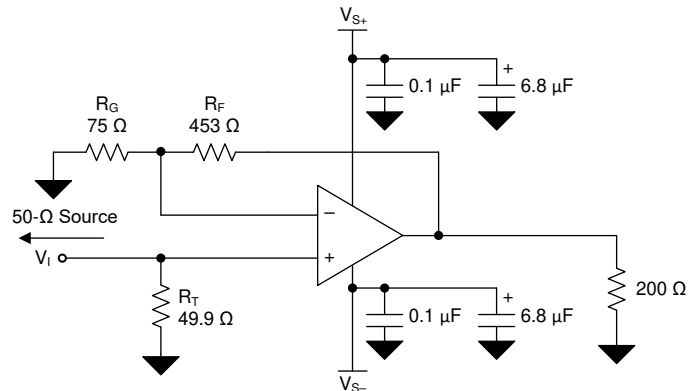

**Figure 10-1. Split and Single Supply Circuit Configuration**

## 11 Layout

### 11.1 Layout Guidelines

Achieving optimum performance with a high-frequency amplifier like the OPA856 requires careful attention to board layout parasitics and external component types. Recommendations that optimize performance include:

- **Minimize parasitic capacitance from the signal I/O pins to ac ground.** Parasitic capacitance on the output and inverting input pins can cause instability. To reduce unwanted capacitance, cut out the power and ground traces under the signal input and output pins. Otherwise, ground and power planes must be unbroken elsewhere on the board. When configuring the amplifier as a TIA, if the required feedback capacitor is less than 0.15 pF, consider using two series resistors, each of half the value of a single resistor in the feedback loop to minimize the parasitic capacitance from the resistor.
- **Minimize the distance (less than 0.25-in) from the power-supply pins to high-frequency bypass capacitors.** Use high-quality, 100-pF to 0.1- $\mu$ F, C0G and NPO-type decoupling capacitors with voltage ratings at least three times greater than the amplifiers maximum power supplies. This configuration makes sure that there is a low-impedance path to the amplifiers power-supply pins across the amplifiers gain bandwidth specification. At the device pins, do not allow the ground and power plane layout to be in close proximity to the signal I/O pins. Avoid narrow power and ground traces to minimize inductance between the pins and the decoupling capacitors. The power-supply connections must always be decoupled with these capacitors. Larger (2.2- $\mu$ F to 6.8- $\mu$ F) decoupling capacitors that are effective at lower frequency must be used on the supply pins. Place these decoupling capacitors further from the device. Share the decoupling capacitors among several devices in the same area of the printed circuit board (PCB).
- **Careful selection and placement of external components preserves the high-frequency performance of the OPA856.** Use low-reactance resistors. Surface-mount resistors work best and allow a tighter overall layout. Never use wirewound resistors in a high-frequency application. Because the output pin and inverting input pin are the most sensitive to parasitic capacitance, always position the feedback and series output resistor, if any, as close to the output pin as possible. Place other network components (such as noninverting input termination resistors) close to the package. Even with a low parasitic capacitance shunting the external resistors, high resistor values create significant time constants that can degrade performance. When configuring the OPA856 as a voltage amplifier, keep resistor values as low as possible and consistent with load driving considerations. Decreasing the resistor values keeps the resistor noise terms low and minimizes the effect of the parasitic capacitance. However, lower resistor values increase the dynamic power consumption because  $R_F$  and  $R_G$  become part of the output load network of the amplifier.

### 11.2 Layout Example

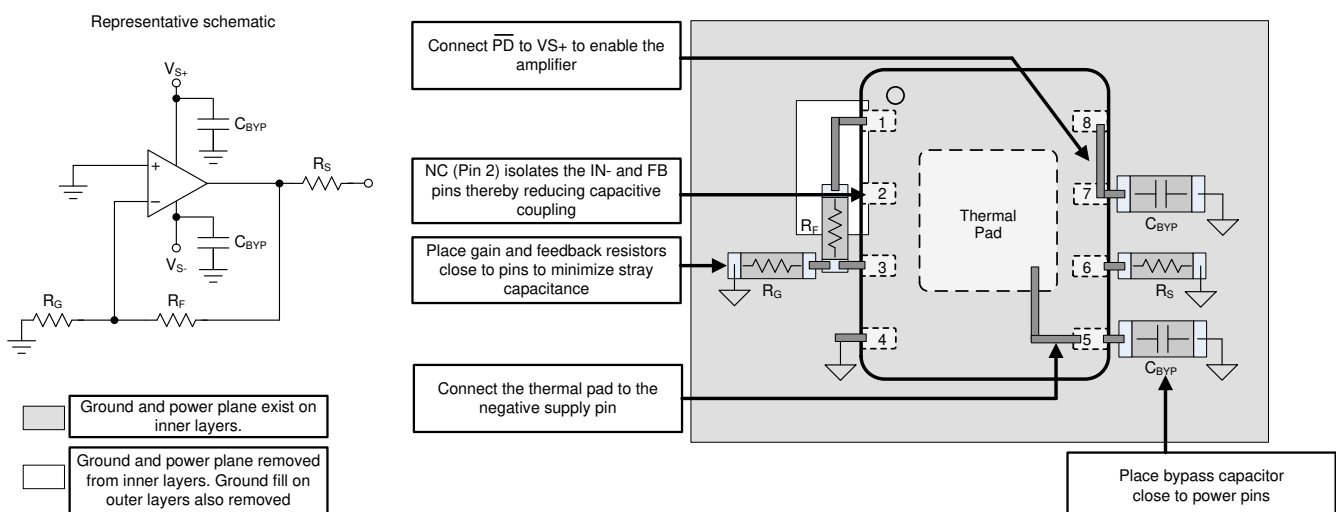

Figure 11-1. Layout Recommendation



## 12 Device and Documentation Support

### 12.1 Device Support

#### 12.1.1 Development Support

- [LIDAR Pulsed Time of Flight Reference Design](#)
- [LIDAR-Pulsed Time-of-Flight Reference Design Using High-Speed Data Converters](#)
- [Wide Bandwidth Optical Front-end Reference Design](#)

### 12.2 Documentation Support

#### 12.2.1 Related Documentation

For related documentation, see the following:

- Texas Instruments, [OPA855EVM user's guide](#)
- Texas Instruments, [Training Video: High-Speed Transimpedance Amplifier Design Flow](#)
- Texas Instruments, [Training Video: How to Design Transimpedance Amplifier Circuits](#)
- Texas Instruments, [Training Video: How to Convert a TINA-TI Model into a Generic SPICE Model](#)
- Texas Instruments, [Transimpedance Considerations for High-Speed Amplifiers application report](#)
- Texas Instruments, [What You Need To Know About Transimpedance Amplifiers – Part 1](#)
- Texas Instruments [What You Need To Know About Transimpedance Amplifiers – Part 2](#)

### 12.3 Receiving Notification of Documentation Updates

To receive notification of documentation updates, navigate to the device product folder on ti.com. In the upper right corner, click on *Alert me* to register and receive a weekly digest of any product information that has changed. For change details, review the revision history included in any revised document.

### 12.4 Support Resources

[TI E2E™ support forums](#) are an engineer's go-to source for fast, verified answers and design help — straight from the experts. Search existing answers or ask your own question to get the quick design help you need.

Linked content is provided "AS IS" by the respective contributors. They do not constitute TI specifications and do not necessarily reflect TI's views; see TI's [Terms of Use](#).

### 12.5 Trademarks

TI E2E™ is a trademark of Texas Instruments.

All trademarks are the property of their respective owners.

### 12.6 Electrostatic Discharge Caution



This integrated circuit can be damaged by ESD. Texas Instruments recommends that all integrated circuits be handled with appropriate precautions. Failure to observe proper handling and installation procedures can cause damage.

ESD damage can range from subtle performance degradation to complete device failure. Precision integrated circuits may be more susceptible to damage because very small parametric changes could cause the device not to meet its published specifications.

### 12.7 Glossary

[TI Glossary](#) This glossary lists and explains terms, acronyms, and definitions.

## 13 Mechanical, Packaging, and Orderable Information

The following pages include mechanical, packaging, and orderable information. This information is the most current data available for the designated devices. This data is subject to change without notice and revision of this document. For browser-based versions of this data sheet, refer to the left-hand navigation.

**PACKAGING INFORMATION**

Orderable Device	Status (1)	Package Type	Package Drawing	Pins	Package Qty	Eco Plan (2)	Lead finish/ Ball material (6)	MSL Peak Temp (3)	Op Temp (°C)	Device Marking (4/5)	Samples
OPA856IDSGR	ACTIVE	WSON	DSG	8	3000	RoHS & Green	NIPDAU	Level-1-260C-UNLIM	-40 to 125	856	Samples

(1) The marketing status values are defined as follows:

**ACTIVE:** Product device recommended for new designs.

**LIFEBUY:** TI has announced that the device will be discontinued, and a lifetime-buy period is in effect.

**NRND:** Not recommended for new designs. Device is in production to support existing customers, but TI does not recommend using this part in a new design.

**PREVIEW:** Device has been announced but is not in production. Samples may or may not be available.

**OBSELETE:** TI has discontinued the production of the device.

(2) **RoHS:** TI defines "RoHS" to mean semiconductor products that are compliant with the current EU RoHS requirements for all 10 RoHS substances, including the requirement that RoHS substance do not exceed 0.1% by weight in homogeneous materials. Where designed to be soldered at high temperatures, "RoHS" products are suitable for use in specified lead-free processes. TI may reference these types of products as "Pb-Free".

**RoHS Exempt:** TI defines "RoHS Exempt" to mean products that contain lead but are compliant with EU RoHS pursuant to a specific EU RoHS exemption.

**Green:** TI defines "Green" to mean the content of Chlorine (Cl) and Bromine (Br) based flame retardants meet JS709B low halogen requirements of <=1000ppm threshold. Antimony trioxide based flame retardants must also meet the <=1000ppm threshold requirement.

(3) MSL, Peak Temp. - The Moisture Sensitivity Level rating according to the JEDEC industry standard classifications, and peak solder temperature.

(4) There may be additional marking, which relates to the logo, the lot trace code information, or the environmental category on the device.

(5) Multiple Device Markings will be inside parentheses. Only one Device Marking contained in parentheses and separated by a "-" will appear on a device. If a line is indented then it is a continuation of the previous line and the two combined represent the entire Device Marking for that device.

(6) Lead finish/Ball material - Orderable Devices may have multiple material finish options. Finish options are separated by a vertical ruled line. Lead finish/Ball material values may wrap to two lines if the finish value exceeds the maximum column width.

**Important Information and Disclaimer:**The information provided on this page represents TI's knowledge and belief as of the date that it is provided. TI bases its knowledge and belief on information provided by third parties, and makes no representation or warranty as to the accuracy of such information. Efforts are underway to better integrate information from third parties. TI has taken and continues to take reasonable steps to provide representative and accurate information but may not have conducted destructive testing or chemical analysis on incoming materials and chemicals. TI and TI suppliers consider certain information to be proprietary, and thus CAS numbers and other limited information may not be available for release.

In no event shall TI's liability arising out of such information exceed the total purchase price of the TI part(s) at issue in this document sold by TI to Customer on an annual basis.

## TAPE AND REEL INFORMATION



### QUADRANT ASSIGNMENTS FOR PIN 1 ORIENTATION IN TAPE



\*All dimensions are nominal

Device	Package Type	Package Drawing	Pins	SPQ	Reel Diameter (mm)	Reel Width W1 (mm)	A0 (mm)	B0 (mm)	K0 (mm)	P1 (mm)	W (mm)	Pin1 Quadrant
OPA856IDSGR	WSON	DSG	8	3000	180.0	8.4	2.3	2.3	1.15	4.0	8.0	Q2

TAPE AND REEL BOX DIMENSIONS



\*All dimensions are nominal

Device	Package Type	Package Drawing	Pins	SPQ	Length (mm)	Width (mm)	Height (mm)
OPA856IDSGR	WSON	DSG	8	3000	210.0	185.0	35.0

## GENERIC PACKAGE VIEW

**DSG 8**

**WSON - 0.8 mm max height**

2 x 2, 0.5 mm pitch

PLASTIC SMALL OUTLINE - NO LEAD

This image is a representation of the package family, actual package may vary.  
Refer to the product data sheet for package details.

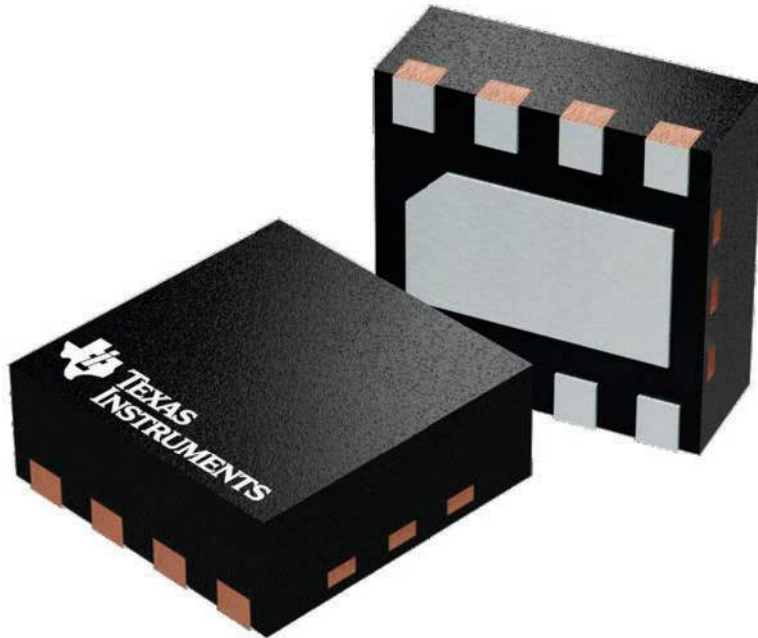

4224783/A

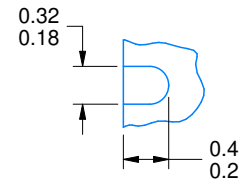
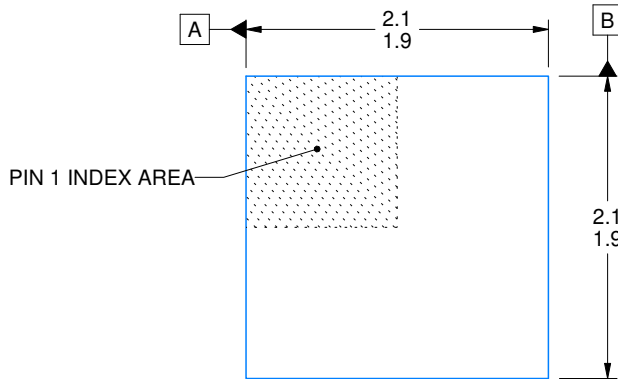

ALTERNATIVE TERMINAL SHAPE TYPICAL

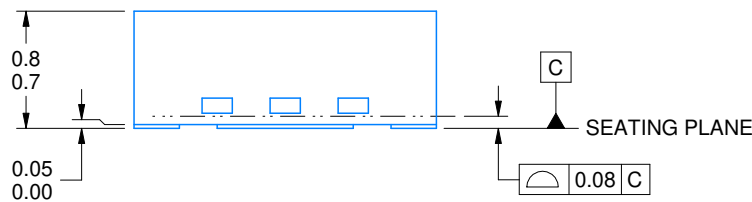

SIDE WALL METAL THICKNESS DIM A	
OPTION 1	OPTION 2
0.1	0.2

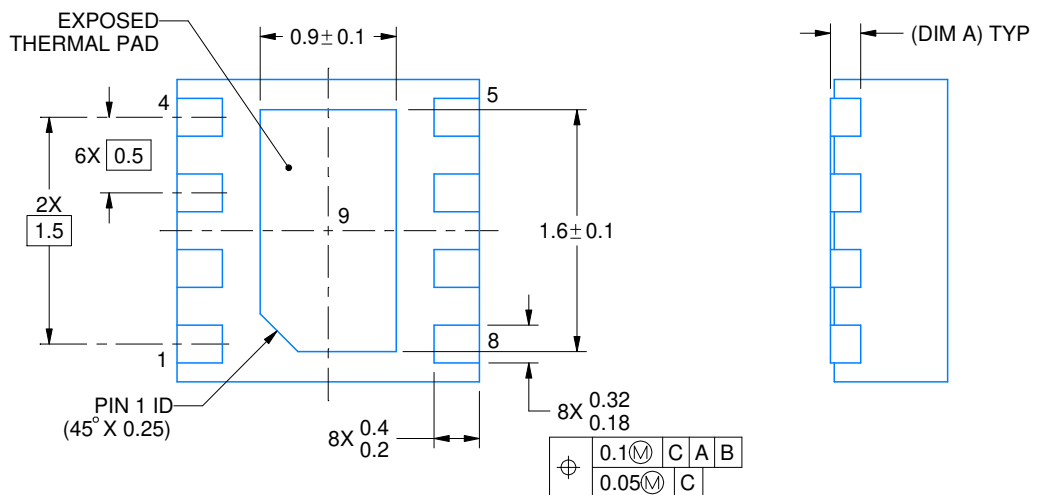

4218900/E 08/2022

NOTES:

1. All linear dimensions are in millimeters. Any dimensions in parenthesis are for reference only. Dimensioning and tolerancing per ASME Y14.5M.
2. This drawing is subject to change without notice.
3. The package thermal pad must be soldered to the printed circuit board for thermal and mechanical performance.

# EXAMPLE BOARD LAYOUT

DSG0008A

WSON - 0.8 mm max height

PLASTIC SMALL OUTLINE - NO LEAD

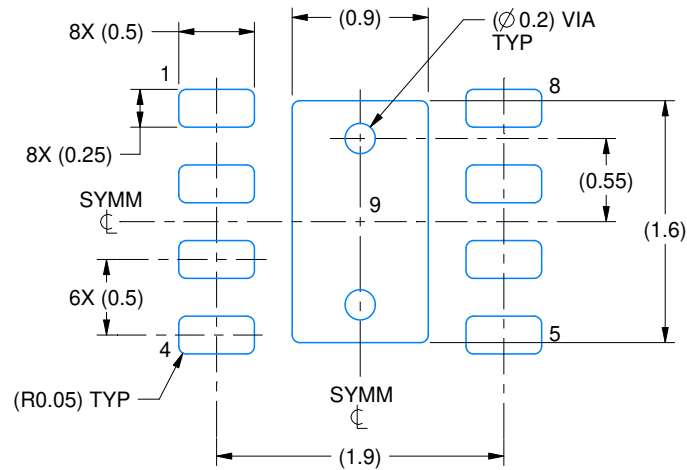

LAND PATTERN EXAMPLE  
SCALE:20X

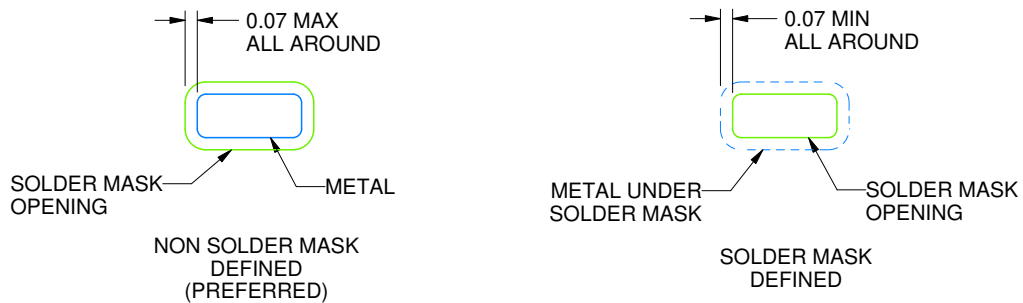

SOLDER MASK DETAILS

4218900/E 08/2022

NOTES: (continued)

4. This package is designed to be soldered to a thermal pad on the board. For more information, see Texas Instruments literature number SLUA271 ([www.ti.com/lit/sluea271](http://www.ti.com/lit/sluea271)).
5. Vias are optional depending on application, refer to device data sheet. If any vias are implemented, refer to their locations shown on this view. It is recommended that vias under paste be filled, plugged or tented.

# EXAMPLE STENCIL DESIGN

DSG0008A

WSON - 0.8 mm max height

PLASTIC SMALL OUTLINE - NO LEAD

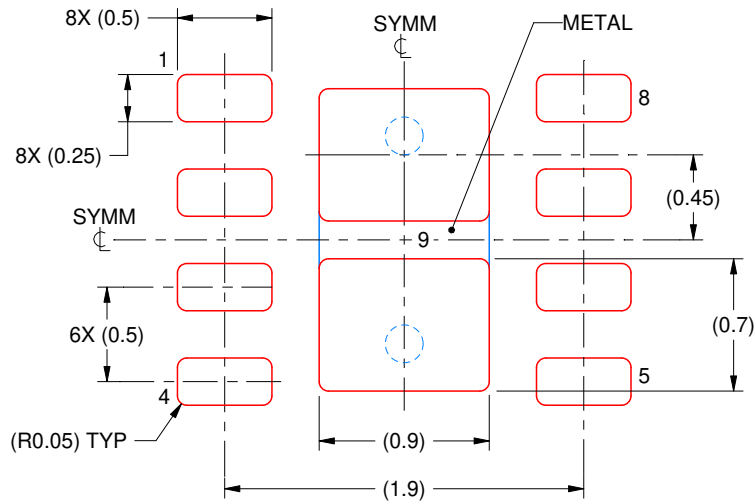

SOLDER PASTE EXAMPLE  
BASED ON 0.125 mm THICK STENCIL

EXPOSED PAD 9:  
87% PRINTED SOLDER COVERAGE BY AREA UNDER PACKAGE  
SCALE:25X

4218900/E 08/2022

NOTES: (continued)

6. Laser cutting apertures with trapezoidal walls and rounded corners may offer better paste release. IPC-7525 may have alternate design recommendations.



## IMPORTANT NOTICE AND DISCLAIMER

TI PROVIDES TECHNICAL AND RELIABILITY DATA (INCLUDING DATA SHEETS), DESIGN RESOURCES (INCLUDING REFERENCE DESIGNS), APPLICATION OR OTHER DESIGN ADVICE, WEB TOOLS, SAFETY INFORMATION, AND OTHER RESOURCES "AS IS" AND WITH ALL FAULTS, AND DISCLAIMS ALL WARRANTIES, EXPRESS AND IMPLIED, INCLUDING WITHOUT LIMITATION ANY IMPLIED WARRANTIES OF MERCHANTABILITY, FITNESS FOR A PARTICULAR PURPOSE OR NON-INFRINGEMENT OF THIRD PARTY INTELLECTUAL PROPERTY RIGHTS.

These resources are intended for skilled developers designing with TI products. You are solely responsible for (1) selecting the appropriate TI products for your application, (2) designing, validating and testing your application, and (3) ensuring your application meets applicable standards, and any other safety, security, regulatory or other requirements.

These resources are subject to change without notice. TI grants you permission to use these resources only for development of an application that uses the TI products described in the resource. Other reproduction and display of these resources is prohibited. No license is granted to any other TI intellectual property right or to any third party intellectual property right. TI disclaims responsibility for, and you will fully indemnify TI and its representatives against, any claims, damages, costs, losses, and liabilities arising out of your use of these resources.

TI's products are provided subject to [TI's Terms of Sale](#) or other applicable terms available either on [ti.com](https://www.ti.com) or provided in conjunction with such TI products. TI's provision of these resources does not expand or otherwise alter TI's applicable warranties or warranty disclaimers for TI products.

TI objects to and rejects any additional or different terms you may have proposed.

Mailing Address: Texas Instruments, Post Office Box 655303, Dallas, Texas 75265  
Copyright © 2023, Texas Instruments Incorporated