

MIPAQ™ base module with Trench/Fieldstop IGBT4 and Emitter Controlled HE diode and NTC / shunt

Features

- Electrical features
 - $V_{CES} = 1200\text{ V}$
 - $I_{C\text{nom}} = 200\text{ A} / I_{CRM} = 400\text{ A}$
 - Low switching losses
 - Low V_{CEsat}
 - $T_{vj\text{op}} = 150\text{ °C}$
- Mechanical features
 - High power and thermal cycling capability
 - Isolated base plate
 - Copper base plate
 - Solder contact technology
 - Standard housing



Typical appearance

Potential applications

- Motor drives
- Servo drives

Product validation

- Qualified for industrial applications according to the relevant tests of IEC 60747, 60749 and 60068

Description

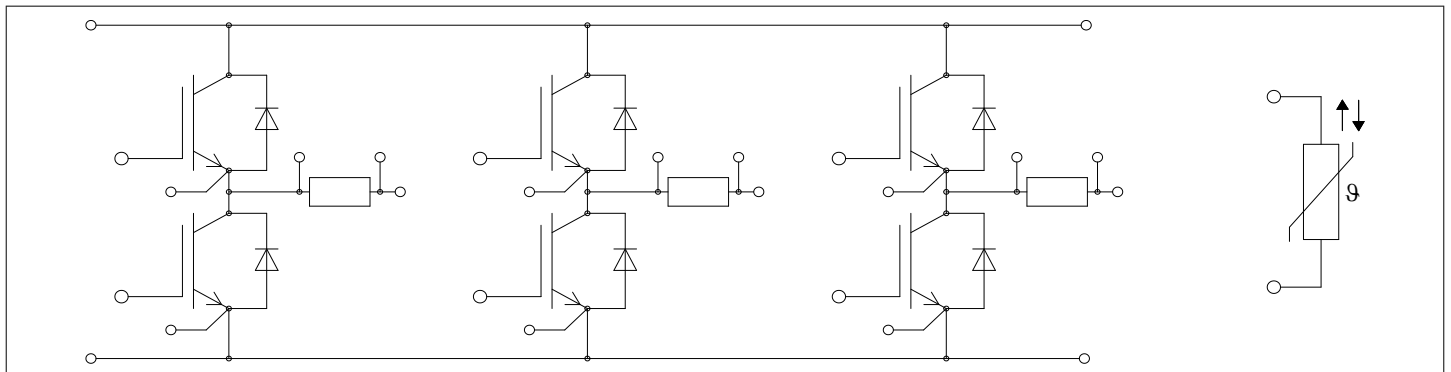

Table of contents

	Description	1
	Features	1
	Potential applications	1
	Product validation	1
	Table of contents	2
1	Package	3
2	IGBT, Inverter	3
3	Diode, Inverter	5
4	NTC-Thermistor	6
5	Shunt	6
6	Characteristics diagrams	7
7	Circuit diagram	10
8	Package outlines	11
	Disclaimer	12

1 Package

Table 1 Insulation coordination

Parameter	Symbol	Note or test condition	Values	Unit
Isolation test voltage	V_{ISOL}	RMS, $f = 50 \text{ Hz}$, $t = 1 \text{ min}$	2.5	kV
Material of module baseplate			Cu	
Internal Isolation		basic insulation (class 1, IEC 61140)	Al_2O_3	
Creepage distance	d_{Creep}	terminal to heatsink	10.0	mm
Clearance	d_{Clear}	terminal to heatsink	7.5	mm
Comparative tracking index	CTI		> 200	
RTI Elec.	RTI	housing	140	°C

Table 2 Characteristic values

Parameter	Symbol	Note or test condition	Values			Unit
			Min.	Typ.	Max.	
Stray inductance module	L_{SCE}			20		nH
Module lead resistance, terminals - chip	$R_{CC'+EE'}$	$T_C = 25^\circ\text{C}$, per switch		1.8		mΩ
Storage temperature	T_{stg}		-40		125	°C
Mounting torque for modul mounting	M	- Mounting according to valid application note	M5, Screw	3	6	Nm
Weight	G			300		g

Note: The current under continuous operation is limited to 50 A rms per connector pin. The shunt value is not a part of the $R_{CC'+EE'}$ resistance.

2 IGBT, Inverter

Table 3 Maximum rated values

Parameter	Symbol	Note or test condition	Values	Unit
Collector-emitter voltage	V_{CES}	$T_{vj} = 25^\circ\text{C}$	1200	V
Continous DC collector current	I_{CDC}	$T_{vj \text{ max}} = 175^\circ\text{C}$ $T_C = 90^\circ\text{C}$	200	A
Repetitive peak collector current	I_{CRM}	$t_p = 1 \text{ ms}$	400	A
Gate-emitter peak voltage	V_{GES}		±20	V

Table 4 Characteristic values

Parameter	Symbol	Note or test condition	Values			Unit
			Min.	Typ.	Max.	
Collector-emitter saturation voltage	$V_{CE\ sat}$	$I_C = 200\ A, V_{GE} = 15\ V$	$T_{vj} = 25\ ^\circ C$	1.75	2.10	V
			$T_{vj} = 125\ ^\circ C$	2.00		
			$T_{vj} = 150\ ^\circ C$	2.05		
Gate threshold voltage	V_{GEth}	$I_C = 7.6\ mA, V_{CE} = V_{GE}, T_{vj} = 25\ ^\circ C$	5.25	5.80	6.35	V
Gate charge	Q_G	$V_{GE} = \pm 15\ V, V_{CE} = 600\ V$		1.65		μC
Internal gate resistor	R_{Gint}	$T_{vj} = 25\ ^\circ C$		3.5		Ω
Input capacitance	C_{ies}	$f = 1000\ kHz, T_{vj} = 25\ ^\circ C, V_{CE} = 25\ V, V_{GE} = 0\ V$		14		nF
Reverse transfer capacitance	C_{res}	$f = 1000\ kHz, T_{vj} = 25\ ^\circ C, V_{CE} = 25\ V, V_{GE} = 0\ V$		0.5		nF
Collector-emitter cut-off current	I_{CES}	$V_{CE} = 1200\ V, V_{GE} = 0\ V$	$T_{vj} = 25\ ^\circ C$		1	mA
Gate-emitter leakage current	I_{GES}	$V_{CE} = 0\ V, V_{GE} = 20\ V, T_{vj} = 25\ ^\circ C$			100	nA
Turn-on delay time (inductive load)	t_{don}	$I_C = 200\ A, V_{CE} = 600\ V, V_{GE} = \pm 15\ V, R_{Gon} = 1\ \Omega$	$T_{vj} = 25\ ^\circ C$	0.140		μs
			$T_{vj} = 125\ ^\circ C$	0.150		
			$T_{vj} = 150\ ^\circ C$	0.150		
Rise time (inductive load)	t_r	$I_C = 200\ A, V_{CE} = 600\ V, V_{GE} = \pm 15\ V, R_{Gon} = 1\ \Omega$	$T_{vj} = 25\ ^\circ C$	0.028		μs
			$T_{vj} = 125\ ^\circ C$	0.034		
			$T_{vj} = 150\ ^\circ C$	0.035		
Turn-off delay time (inductive load)	t_{doff}	$I_C = 200\ A, V_{CE} = 600\ V, V_{GE} = \pm 15\ V, R_{Goff} = 1\ \Omega$	$T_{vj} = 25\ ^\circ C$	0.320		μs
			$T_{vj} = 125\ ^\circ C$	0.410		
			$T_{vj} = 150\ ^\circ C$	0.440		
Fall time (inductive load)	t_f	$I_C = 200\ A, V_{CE} = 600\ V, V_{GE} = \pm 15\ V, R_{Goff} = 1\ \Omega$	$T_{vj} = 25\ ^\circ C$	0.043		μs
			$T_{vj} = 125\ ^\circ C$	0.079		
			$T_{vj} = 150\ ^\circ C$	0.088		
Turn-on energy loss per pulse	E_{on}	$I_C = 200\ A, V_{CE} = 600\ V, L_\sigma = 30\ nH, V_{GE} = \pm 15\ V, R_{Gon} = 1\ \Omega, di/dt = 5500\ A/\mu s (T_{vj} = 150\ ^\circ C)$	$T_{vj} = 25\ ^\circ C$	13		mJ
			$T_{vj} = 125\ ^\circ C$	21		
			$T_{vj} = 150\ ^\circ C$	23.5		
Turn-off energy loss per pulse	E_{off}	$I_C = 200\ A, V_{CE} = 600\ V, L_\sigma = 30\ nH, V_{GE} = \pm 15\ V, R_{Goff} = 1\ \Omega, dv/dt = 3300\ V/\mu s (T_{vj} = 150\ ^\circ C)$	$T_{vj} = 25\ ^\circ C$	15.5		mJ
			$T_{vj} = 125\ ^\circ C$	24		
			$T_{vj} = 150\ ^\circ C$	26.5		
SC data	I_{SC}	$V_{GE} \leq 15\ V, V_{CC} = 800\ V, V_{CEmax} = V_{CES} - L_{sCE} * di/dt$	$t_p \leq 10\ \mu s, T_{vj} = 150\ ^\circ C$	800		A
Thermal resistance, junction to case	R_{thJC}	per IGBT			0.160	K/W

Table 4 Characteristic values (continued)

Parameter	Symbol	Note or test condition	Values			Unit
			Min.	Typ.	Max.	
Thermal resistance, case to heatsink	R_{thCH}	per IGBT, $\lambda_{grease} = 1 \text{ W/(m}^2\text{K)}$		0.0540		K/W
Temperature under switching conditions	T_{vjop}		-40		150	°C

3 Diode, Inverter

Table 5 Maximum rated values

Parameter	Symbol	Note or test condition	Values	Unit	
Repetitive peak reverse voltage	V_{RRM}	$T_{vj} = 25 \text{ }^\circ\text{C}$	1200	V	
Continuous DC forward current	I_F		200	A	
Repetitive peak forward current	I_{FRM}	$t_p = 1 \text{ ms}$	400	A	
I^2t - value	I^2t	$t_p = 10 \text{ ms}, V_R = 0 \text{ V}$	$T_{vj} = 125 \text{ }^\circ\text{C}$	7800	A^2s
			$T_{vj} = 150 \text{ }^\circ\text{C}$	7400	

Table 6 Characteristic values

Parameter	Symbol	Note or test condition	Values			Unit	
			Min.	Typ.	Max.		
Forward voltage	V_F	$I_F = 200 \text{ A}, V_{GE} = 0 \text{ V}$	$T_{vj} = 25 \text{ }^\circ\text{C}$		1.70	2.15	V
			$T_{vj} = 125 \text{ }^\circ\text{C}$		1.65		
			$T_{vj} = 150 \text{ }^\circ\text{C}$		1.65		
Peak reverse recovery current	I_{RM}	$V_R = 600 \text{ V}, I_F = 200 \text{ A}, V_{GE} = -15 \text{ V}, -di_F/dt = 5500 \text{ A}/\mu\text{s} (T_{vj} = 150 \text{ }^\circ\text{C})$	$T_{vj} = 25 \text{ }^\circ\text{C}$		195		A
			$T_{vj} = 125 \text{ }^\circ\text{C}$		215		
			$T_{vj} = 150 \text{ }^\circ\text{C}$		220		
Recovered charge	Q_r	$V_R = 600 \text{ V}, I_F = 200 \text{ A}, V_{GE} = -15 \text{ V}, -di_F/dt = 5500 \text{ A}/\mu\text{s} (T_{vj} = 150 \text{ }^\circ\text{C})$	$T_{vj} = 25 \text{ }^\circ\text{C}$		18		μC
			$T_{vj} = 125 \text{ }^\circ\text{C}$		33		
			$T_{vj} = 150 \text{ }^\circ\text{C}$		37		
Reverse recovery energy	E_{rec}	$V_R = 600 \text{ V}, I_F = 200 \text{ A}, V_{GE} = -15 \text{ V}, -di_F/dt = 5500 \text{ A}/\mu\text{s} (T_{vj} = 150 \text{ }^\circ\text{C})$	$T_{vj} = 25 \text{ }^\circ\text{C}$		8.85		mJ
			$T_{vj} = 125 \text{ }^\circ\text{C}$		17.5		
			$T_{vj} = 150 \text{ }^\circ\text{C}$		20		
Thermal resistance, junction to case	R_{thJC}	per diode			0.250	K/W	

Table 6 Characteristic values (continued)

Parameter	Symbol	Note or test condition	Values			Unit
			Min.	Typ.	Max.	
Thermal resistance, case to heatsink	R_{thCH}	per diode, $\lambda_{grease} = 1 \text{ W/(m}^2\text{K)}$		0.0720		K/W
Temperature under switching conditions	$T_{vj\ op}$		-40		150	°C

4 NTC-Thermistor

Table 7 Characteristic values

Parameter	Symbol	Note or test condition	Values			Unit
			Min.	Typ.	Max.	
Rated resistance	R_{25}	$T_{NTC} = 25 \text{ }^\circ\text{C}$		5		kΩ
Deviation of R_{100}	$\Delta R/R$	$T_{NTC} = 100 \text{ }^\circ\text{C}$, $R_{100} = 493 \text{ } \Omega$	-5		5	%
Power dissipation	P_{25}	$T_{NTC} = 25 \text{ }^\circ\text{C}$			20	mW
B-value	$B_{25/50}$	$R_2 = R_{25} \exp[B_{25/50}(1/T_2 - 1/(298,15 \text{ K}))]$		3375		K
B-value	$B_{25/80}$	$R_2 = R_{25} \exp[B_{25/80}(1/T_2 - 1/(298,15 \text{ K}))]$		3411		K
B-value	$B_{25/100}$	$R_2 = R_{25} \exp[B_{25/100}(1/T_2 - 1/(298,15 \text{ K}))]$		3433		K

Note: Specification according to the valid application note.

5 Shunt

Table 8 Characteristic values

Parameter	Symbol	Note or test condition	Values			Unit
			Min.	Typ.	Max.	
Rated resistance	R_{20}			0.53		mΩ
Temperature coefficient	TCR	$T_{Range} = +20/+60 \text{ }^\circ\text{C}$			30	ppm/K
Operation temperature	$T_{vj\ op}$				200	°C
Thermal resistance, junction to case	R_{thJC}	per shunt			6.55	K/W
Thermal resistance, case to heatsink	R_{thCH}	per shunt		0.312		K/W

6 Characteristics diagrams

switching losses (typical), IGBT, Inverter

$$E = f(I_C)$$

$$R_{Goff} = 1 \Omega, R_{Gon} = 1 \Omega, V_{CE} = 600 \text{ V}, V_{GE} = \pm 15 \text{ V}$$

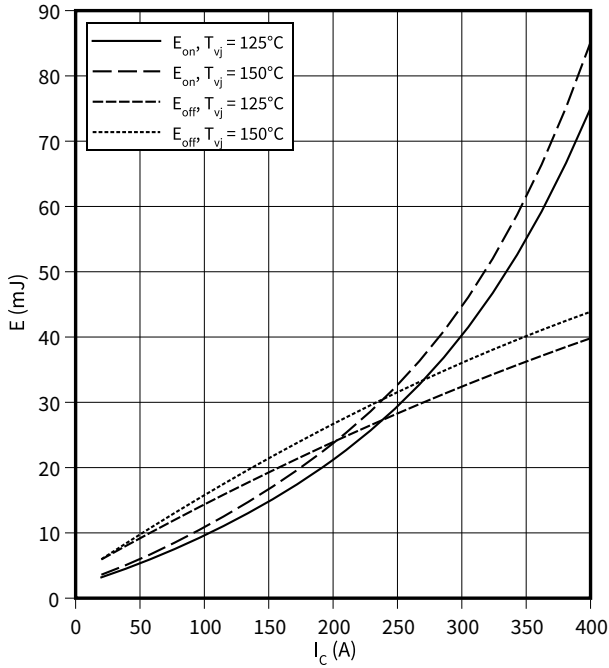

switching losses (typical), IGBT, Inverter

$$E = f(R_G)$$

$$I_C = 200 \text{ A}, V_{CE} = 600 \text{ V}, V_{GE} = \pm 15 \text{ V}$$

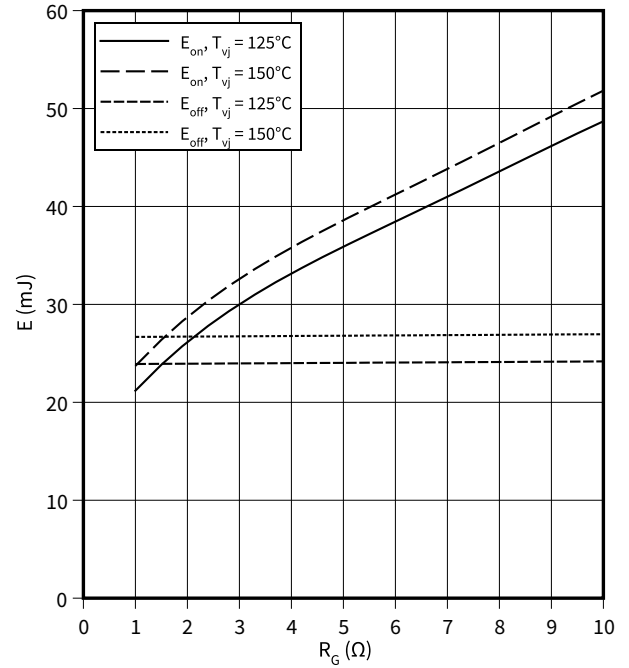

reverse bias safe operating area (RBSOA), IGBT, Inverter

$$I_C = f(V_{CE})$$

$$R_{Goff} = 1 \Omega, V_{GE} = \pm 15 \text{ V}, T_{vj} = 150 \text{ }^\circ\text{C}$$

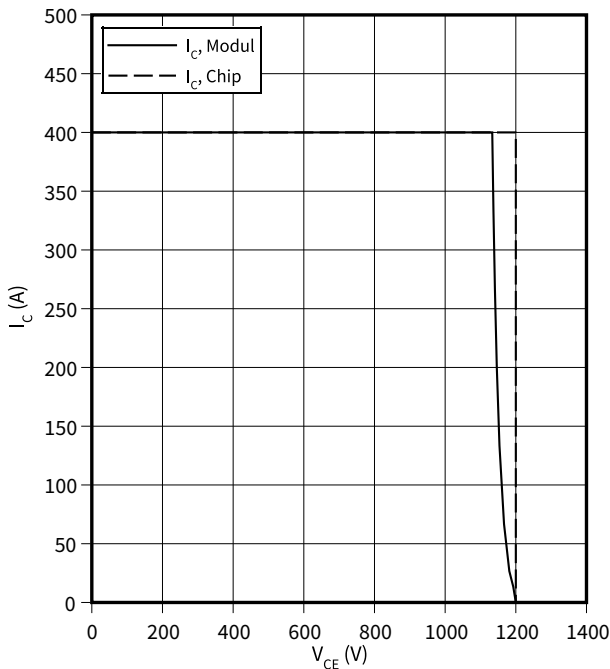

output characteristic (typical), IGBT, Inverter

$$I_C = f(V_{CE})$$

$$V_{GE} = 15 \text{ V}$$

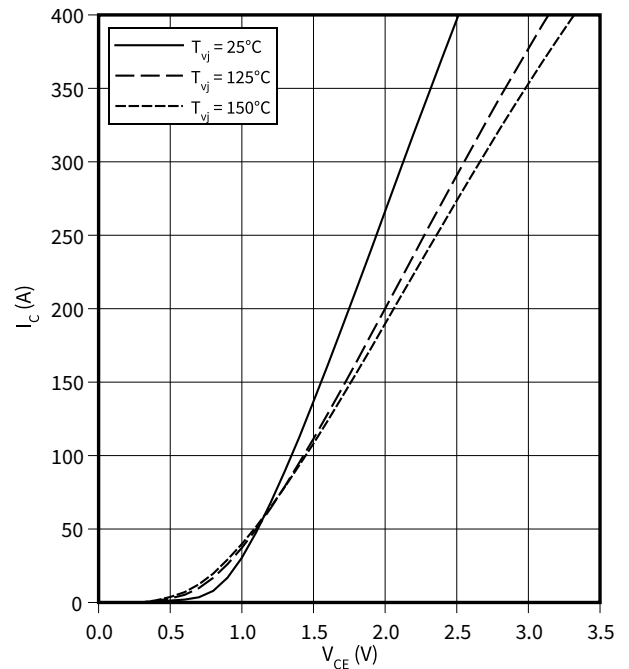

6 Characteristics diagrams

output characteristic (typical), IGBT, Inverter

$I_C = f(V_{CE})$
 $T_{vj} = 150\text{ °C}$

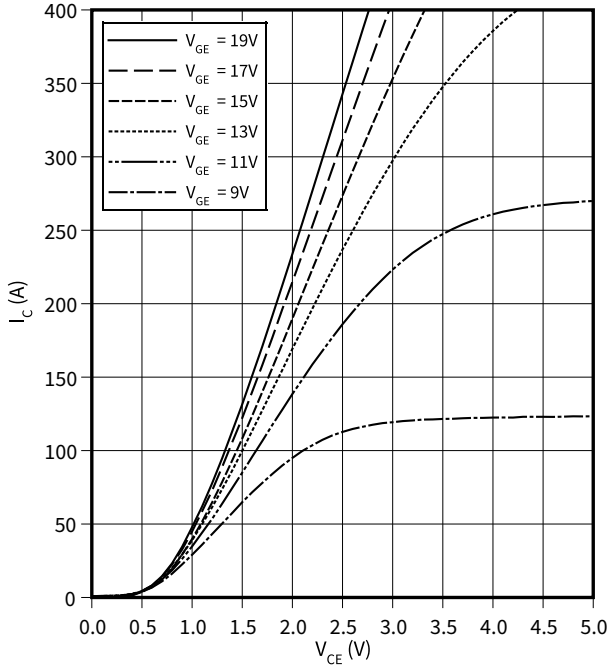

transfer characteristic (typical), IGBT, Inverter

$I_C = f(V_{GE})$
 $V_{CE} = 600\text{ V}$

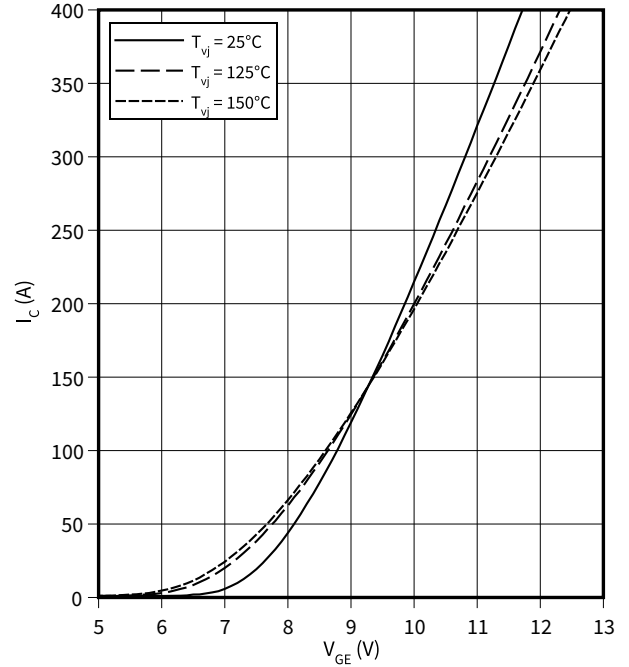

transient thermal impedance , IGBT, Inverter

$Z_{th} = f(t)$

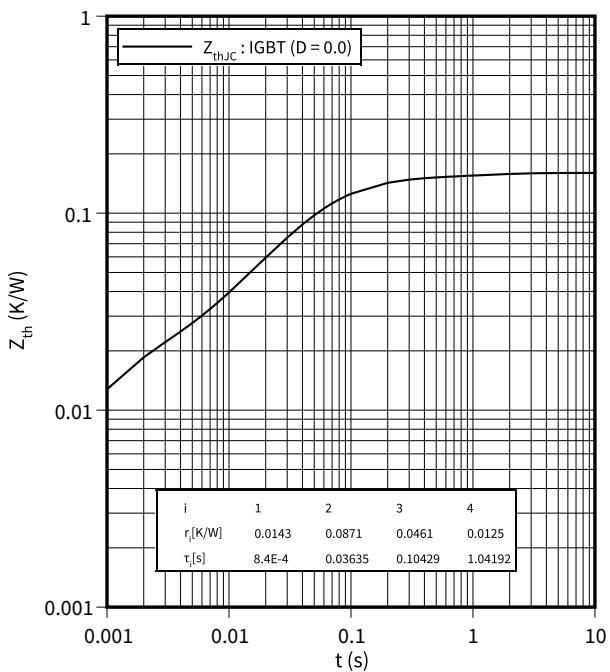

forward characteristic (typical), Diode, Inverter

$I_F = f(V_F)$

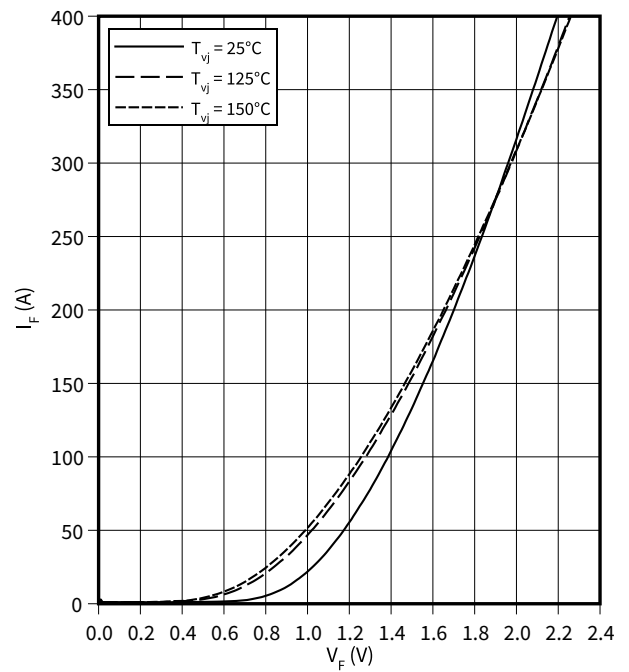

6 Characteristics diagrams

switching losses (typical), Diode, Inverter

$E_{rec} = f(I_F)$

$V_{CE} = 600\text{ V}, R_{Gon} = R_{Gon}(IGBT)$

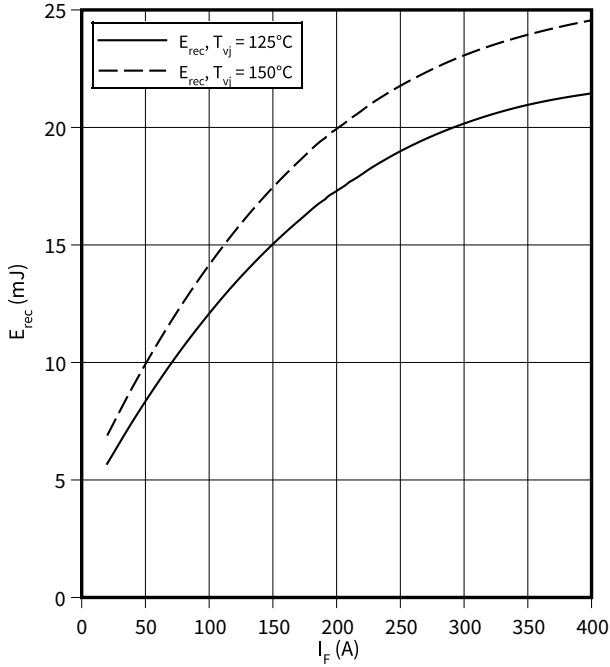

switching losses (typical), Diode, Inverter

$E_{rec} = f(R_G)$

$V_{CE} = 600\text{ V}, I_F = 200\text{ A}$

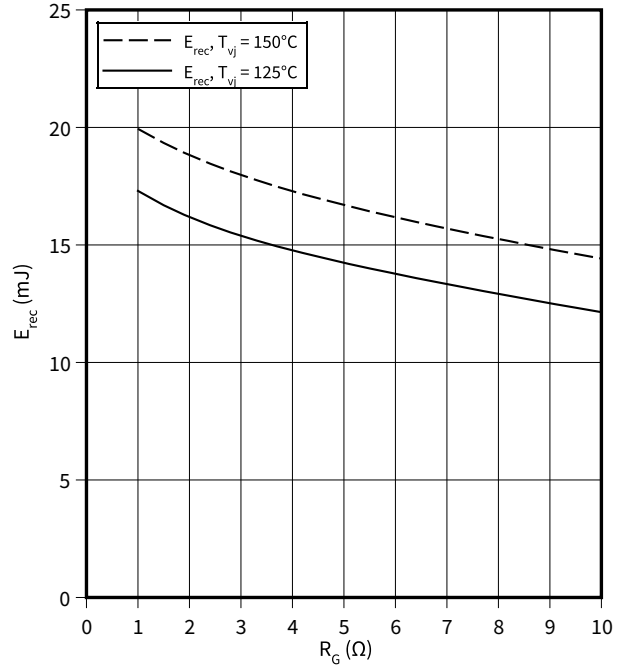

transient thermal impedance , Diode, Inverter

$Z_{th} = f(t)$

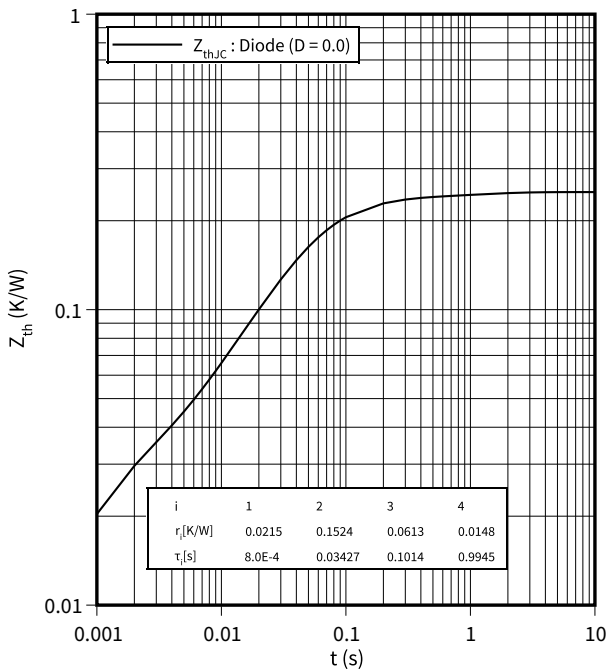

temperature characteristic (typical), NTC-Thermistor

$R = f(T_{NTC})$

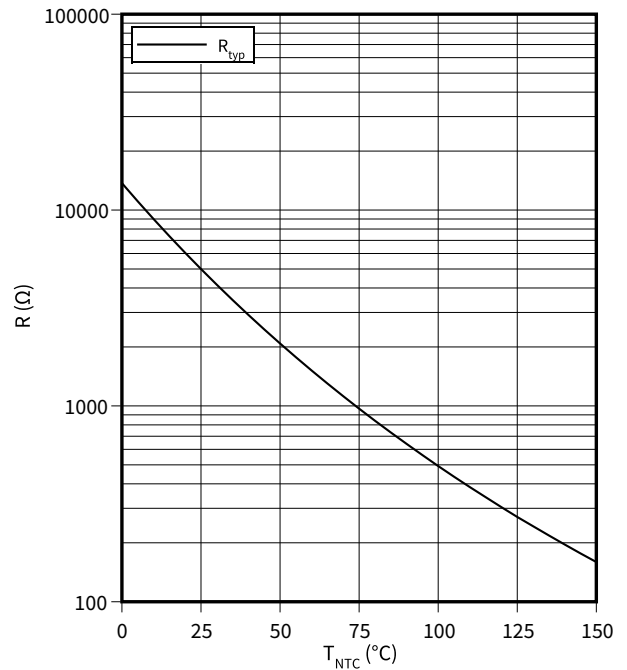

7 Circuit diagram

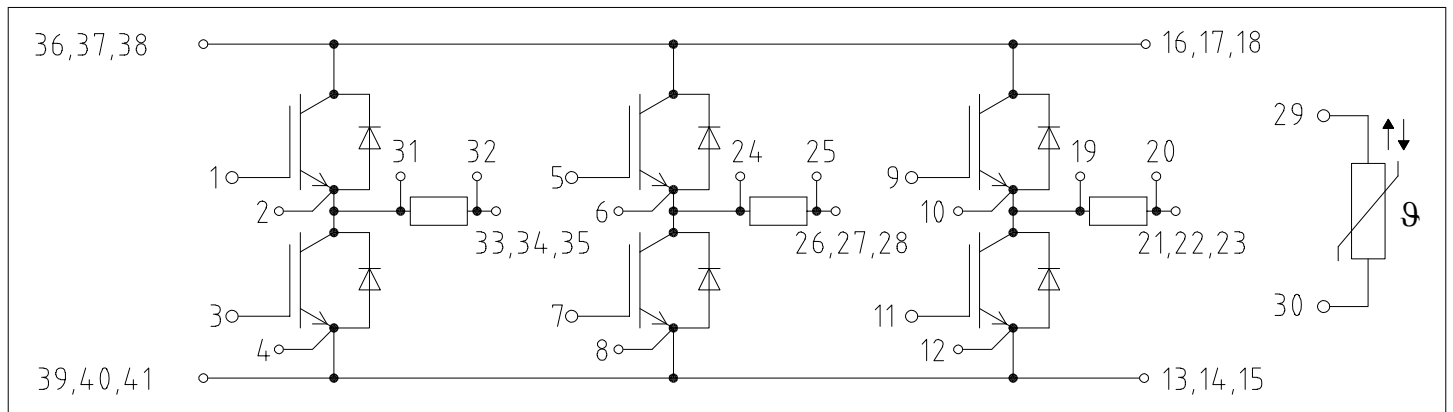

Figure 2

Trademarks

All referenced product or service names and trademarks are the property of their respective owners.

Edition 2021-03-31

Published by

Infineon Technologies AG

81726 Munich, Germany

© 2021 Infineon Technologies AG

All Rights Reserved.

Do you have a question about any aspect of this document?

Email: erratum@infineon.com

Document reference

IFX-

IMPORTANT NOTICE

The information given in this document shall in no event be regarded as a guarantee of conditions or characteristics ("Beschaffenhheitsgarantie").

With respect to any examples, hints or any typical values stated herein and/or any information regarding the application of the product, Infineon Technologies hereby disclaims any and all warranties and liabilities of any kind, including without limitation warranties of non-infringement of intellectual property rights of any third party.

In addition, any information given in this document is subject to customer's compliance with its obligations stated in this document and any applicable legal requirements, norms and standards concerning customer's products and any use of the product of Infineon Technologies in customer's applications.

The data contained in this document is exclusively intended for technically trained staff. It is the responsibility of customer's technical departments to evaluate the suitability of the product for the intended application and the completeness of the product information given in this document with respect to such application.

WARNINGS

Due to technical requirements products may contain dangerous substances. For information on the types in question please contact your nearest Infineon Technologies office.

Except as otherwise explicitly approved by Infineon Technologies in a written document signed by authorized representatives of Infineon Technologies, Infineon Technologies' products may not be used in any applications where a failure of the product or any consequences of the use thereof can reasonably be expected to result in personal injury.