



NMO Mount Combo 28 dB GPS/GLNSS Vehicular Antenna NMO Mount/SMA Connectors RG58 cable

Antennas Technical Data Sheet

PE51GPS1002

Features

- Low-Profile aesthetics for reduced visibility
- RG58 NMO mount
- UV Stabalized, High Impact Xenoy™ housing
- Integrated GPS/GLNSS Antenna
- Rugged aluminum die cast base high strenght mechanical mounting and reliability
- Silicone Rubber gasket and dual O-ring seals for waterproof, high pressure car wash (IP66) applications

Applications

- Service Vehicles
- Public Safety
- Public Transportation
- Mining & Construction

Description

This NMO combination mount with an integrated GPS/GLNSS antenna is ideally suited for multipoint mobile applications including service vehicles, public transportation, public safety, mining and construction vehicles, as well numerous other commercial and industrial applications where mobility and wide coverage is desired. The mount allows the user to mount any NMO-mount antenna of choice.

Configuration

Design	GPS/GLNSS Vehicular
Band Type	Single
Cable Type	RG58
Cable Length	204 in [518.16 cm]
Connector Type	NMO Mount
Interface 2	SMA Plug
Housing Material and Plating	Black

Electrical Specifications

Description	Minimum	Typical	Maximum	Units
Frequency Range	1,575		1,615	GHz
Input VSWR			2:1	
Output VSWR			2:1	
Impedance		50		Ohms
Gain		28		dB
Input Power			10	Watts
Operating DC Voltage	2.5		5.5	Volts
Current	5		20	mA
Filter Type		SAW		
Attenuation wrt L1 (DC-1.52 GHz)	28			dB
Attenuation wrt L1 (1.66-3 GHz)	30			dB

NMO Mount Electrical Specifications

Description	Minimum	Typical	Maximum	Units
Cable Type		RG58		

Click the following link (or enter part number in "SEARCH" on website) to obtain additional part information including price, inventory and certifications: [NMO Mount Combo 28 dB GPS/GLNSS Vehicular Antenna NMO Mount/SMA Connectors RG58 cable PE51GPS1002](#)



NMO Mount Combo 28 dB GPS/GLNSS Vehicular
Antenna NMO Mount/SMA Connectors RG58 cable

Antennas Technical Data Sheet

PE51GPS1002

Frequency Band	30 to 100	MHz
Impedance	50	Ohms
VSWR	1.5	
Insertion Loss	2.5	dB
Power Rating	150	W

Passive Element Specifications

Description	Minimum	Typical	Maximum	Units
Center Frequency Band		1.5925		GHz
Impedance		50		Ohms
Antenna VSWR			2	
Polarization		RHCP		

Click the following link (or enter part number in "SEARCH" on website) to obtain additional part information including price, inventory and certifications: [NMO Mount Combo 28 dB GPS/GLNSS Vehicular Antenna NMO Mount/SMA Connectors RG58 cable PE51GPS1002](#)



NMO Mount Combo 28 dB GPS/GLNSS Vehicular
Antenna NMO Mount/SMA Connectors RG58 cable

Antennas Technical Data Sheet

PE51GPS1002

Mechanical Specifications

Housing Plating/Color	Black
Radiator Material	Ceramic
Radiator Finish	Silver
Mounting Application	Bulkhead ¼ in. Thru-Hole

Size

Overall Length	4.5 in [114.3 mm]
Width	2.2 in [55.88 mm]
Height	0.88 in [22.35 mm]
Color	Black

Click the following link (or enter part number in "SEARCH" on website) to obtain additional part information including price, inventory and certifications: [NMO Mount Combo 28 dB GPS/GLNSS Vehicular Antenna NMO Mount/SMA Connectors RG58 cable PE51GPS1002](#)



NMO Mount Combo 28 dB GPS/GLNSS Vehicular Antenna NMO Mount/SMA Connectors RG58 cable

Antennas Technical Data Sheet

PE51GPS1002

Installation Instructions

Parts (Figure 1): Verify all parts are included as shown in Figure 1.

- A. Antenna Base Mount with 17 ft. (5.1 m):
 - RG-174/U GPS Cable (Connector Attached)
 - RG-58/U or 195 Type NMO Cable (Connector Sold Separately)
- B. Rubber Gasket
- C. Multi-tooth Lock Washer-Nut (24 mm Hex)

Tools Required:

- Drill and Hole Punch, 3/4" (19.05mm) Diameter
- 24 mm Socket Wrench or Open/Adjustable Wrench
- Torque Wrench with 15 to 20 ft-lb capacity (Recommended)
- Cable Stripping Tools for RG-58/U or 195 type cable

Pre-Installation Checklist and Tips:

- GPS/NMO Base mount will install on any panel with thickness up to 1/4" (6.35 mm) maximum.
- NMO Mount will accommodate all NMO antennas with operational frequency bands up to 1000 MHz.
- **NMO Antenna: Sold separately.** Refer to manufacturer's antennas instructions to verify proper installation and tuning requirements.
- For best GPS+GLNSS Antenna performance, verify installation area has clear view of sky in all directions.
- Mounting locations that contain obstructions within low view angles (near horizon) may be permissible, however, to ensure performance is acceptable, the antenna may be tested in the desired mounting location by setting the base mount upright on the mounting surface and connecting the GPS+GLNSS receiver to determine performance.
- Choose mounting surface with minimal curvature to optimize the rubber gasket sealing against rain and weather.

Installation:

1. Drill or punch a 3/4" (19.05 mm) hole through the mounting surface.
2. Clean surface area near mounting hole, removing grit, moisture and oil residue to ensure proper gasket seal.
3. Remove Lock Washer-Nut from the threaded stanchion.
4. Feed antenna cables through the top of the hole.
5. Verify gasket is properly aligned and seated to mount base and perimeter. **Note:** Gasket is not symmetrical.
6. Insert threaded stanchion through the hole.
7. Before attaching Lock Washer-Nut, verify gasket is seated firmly against the mount base.
8. Apply firm downward pressure to mount base, ensuring gasket is fully seated against mounting surface.
9. Gently pull cables downward, then horizontally into the cable relief slot as shown in FIGURE 2. **NOTE:** It may help to temporarily tape the cables to the bottom side of the mounting surface in order to hold them in the slot location until the nut is completely fastened with proper torque.



FIGURE 1: PARTS

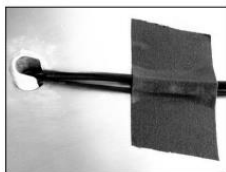

FIGURE 2: BOTTOM SIDE INSTALLATION SURFACE



FIGURE 3: CABLE ROUTING

10. Attach and thread the Lock Washer-Nut to the threaded stanchion using hand torque only until toothed lock washer stops against the bottom side of the mounting surface. See FIGURE 3.
11. Determine the final rotational position of the base mount and begin to apply light torque with wrench.
12. Verify final position of base mount. Firmly secure the assembly by using a torque wrench. Torque the Lock Washer-Nut to a minimum of 15 ft-lbs./maximum 20 ft-lbs.
13. Route cables to radio/receiver locations.
14. Cut and Strip NMO cable (RG-58/U or 195 type). Attach connector (sold separately).

Click the following link (or enter part number in "SEARCH" on website) to obtain additional part information including price, inventory and certifications: [NMO Mount Combo 28 dB GPS/GLNSS Vehicular Antenna NMO Mount/SMA Connectors RG58 cable PE51GPS1002](#)



NMO Mount Combo 28 dB GPS/GLNSS Vehicular Antenna NMO Mount/SMA Connectors RG58 cable

Antennas Technical Data Sheet

PE51GPS1002

Environmental Specifications

Temperature

Operating Range

-40 to +85 deg C

Humidity

95%

Vibration

AAR & MIL-STD-810E

Corrosion

Salt Fog

ESD Protection

IP66

Compliance Certifications (see [product page](#) for current document)

Plotted and Other Data

Notes:

Typical Radiation Pattern

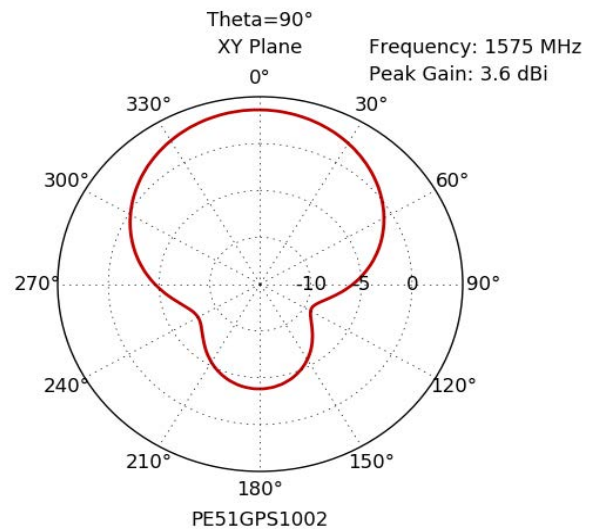
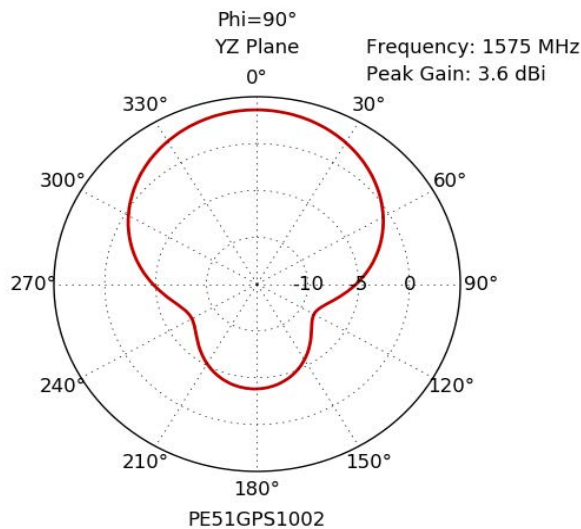

Click the following link (or enter part number in "SEARCH" on website) to obtain additional part information including price, inventory and certifications: [NMO Mount Combo 28 dB GPS/GLNSS Vehicular Antenna NMO Mount/SMA Connectors RG58 cable PE51GPS1002](#)



NMO Mount Combo 28 dB GPS/GLNSS Vehicular
Antenna NMO Mount/SMA Connectors RG58 cable

Antennas Technical Data Sheet

PE51GPS1002

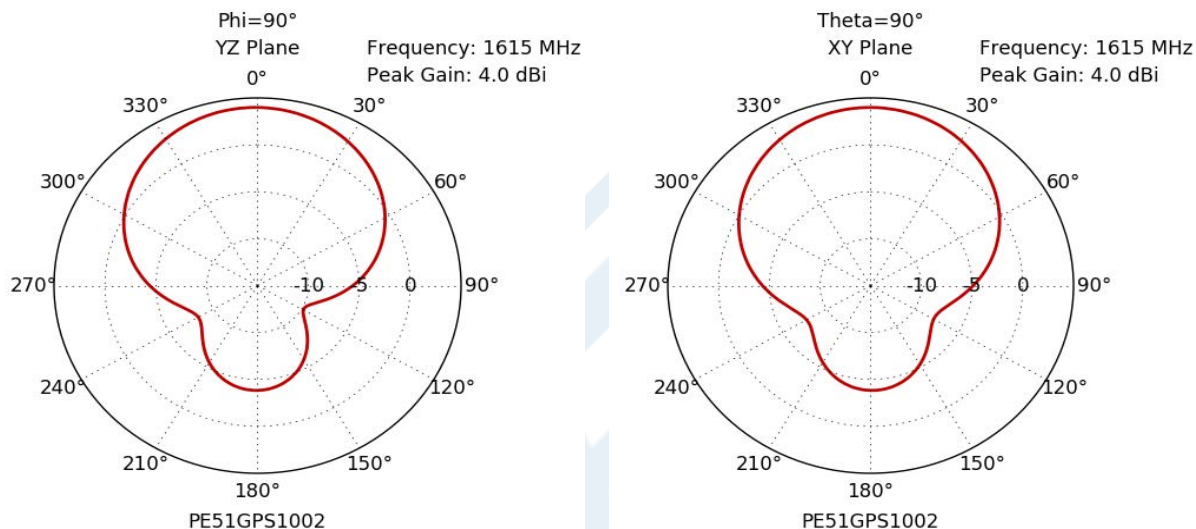

NMO Mount Combo 28 dB GPS/GLNSS Vehicular Antenna NMO Mount/SMA Connectors RG58 cable from Pasternack Enterprises has same day shipment for domestic and International orders. Our RF, microwave and millimeter wave products maintain a 99.4% availability and are part of the broadest selection in the industry.

Click the following link (or enter part number in "SEARCH" on website) to obtain additional part information including price, inventory and certifications: [NMO Mount Combo 28 dB GPS/GLNSS Vehicular Antenna NMO Mount/SMA Connectors RG58 cable PE51GPS1002](https://www.pasternack.com/single-antenna-1.575-1.615-ghz-28-db-gain-nmo-mount-pe51gps1002-p.aspx)

URL: <https://www.pasternack.com/single-antenna-1.575-1.615-ghz-28-db-gain-nmo-mount-pe51gps1002-p.aspx>

The information contained in this document is accurate to the best of our knowledge and representative of the part described herein. It may be necessary to make modifications to the part and/or the documentation of the part, in order to implement improvements. Pasternack reserves the right to make such changes as required. Unless otherwise stated, all specifications are nominal. Pasternack does not make any representation or warranty regarding the suitability of the part described herein for any particular purpose, and Pasternack does not assume any liability arising out of the use of any part or documentation.

PE51GPS1002 CAD Drawing

NMO Mount Combo 28 dB GPS/GLNSS Vehicular Antenna

NMO Mount/SMA Connectors RG58 cable

REVISIONS			
REV.	DESCRIPTION	DATE	APPROVED
A	INITIAL RELEASE	08/07/2019	MMILLER

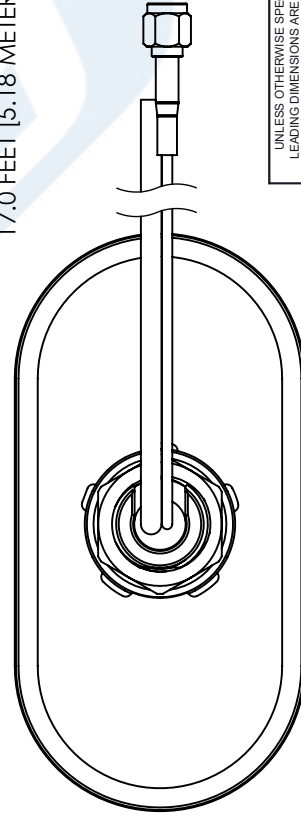
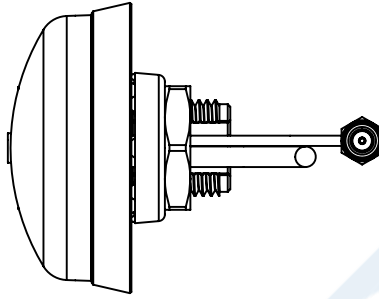
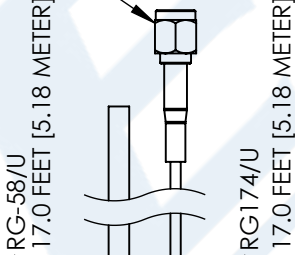
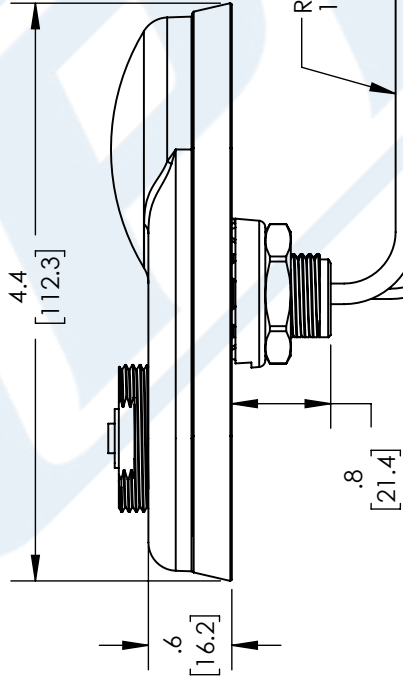
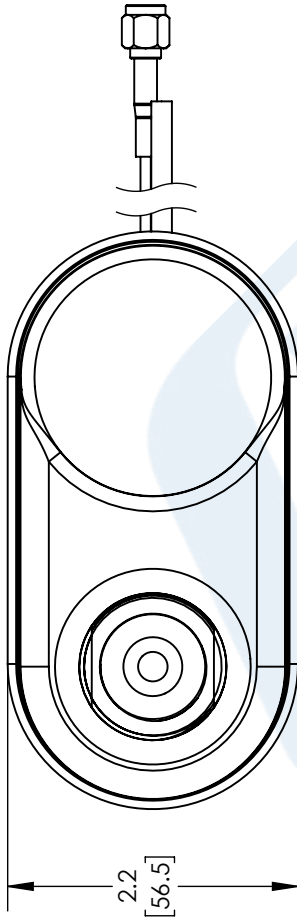

UNLESS OTHERWISE SPECIFIED LEADING DIMENSIONS ARE INCHES DIMENSIONS IN [] ARE MILLIMETERS	
TOLERANCES:	FRACTIONS
X±.2 [5.08]	+1/32
XX±.01 [.25]	ANGLES ± 1°
XXX±.005 [.13]	
ALL DIMENSIONS SHOWN ARE FOR REFERENCE ONLY.	
THIRD-ANGLE PROJECTION	

(PE) PASTERNAK
an INFINITO brand

Pasternack Enterprises, Inc.
P.O. Box 16759, Irvine, CA 92623.
Phone: 1.949.261.1920 | 1.866.727.8376
Fax: 1.949.261.7451
www.pasternack.com | e-mail: sales@pasternack.com

THE INFORMATION AND DESIGN IN THIS DOCUMENT IS THE PROPERTY OF PASTERNAK CORPORATION. ALL RIGHTS RESERVED.

SHEET 1 OF 1
SCALE N/A

SIZE A CAGE NUMBER 53919 DRAWN BY BPUCHASKI PART NUMBER PE51GPS1002 REV A

THESE COMMODITIES, TECHNOLOGY OR SOFTWARE WERE EXPORTED FROM THE UNITED STATES IN ACCORDANCE WITH THE EXPORT ADMINISTRATION REGULATIONS. DIVERSION CONTRARY TO U.S. LAW PROHIBITED.