



Main

Range of Product	Telemecanique Photoelectric sensors XU
Series name	General purpose single mode
Electronic sensor type	Photo-electric sensor
Sensor name	XUX
Sensor design	Compact 92 x 71
Detection system	Diffuse with background suppression
Material	Plastic
Type of output signal	Discrete
Supply circuit type	DC
Wiring Technique	3-wire
Discrete output type	PNP or NPN
Discrete output function	1 NO or 1 NC programmable
Electrical connection	1 male connector M12, 4 pins
Product Specific Application	Long sensing distance with high accuracy
Emission	Infrared
[Sn] nominal sensing distance	6.56 ft (2 m)

Complementary

Enclosure Material	PC
Lens material	PMMA
Output Type	Solid state
Status LED	Supply on 1 LED green) Instability 1 LED red) Output state 1 LED yellow)
[Us] rated supply voltage	12...24 V DC reverse polarity protection
Supply voltage limits	10...36 V DC
Switching capacity in mA	<= 100 mA overload and short-circuit protection)
Switching frequency	150 Hz
Maximum voltage drop	<1.5 V closed state)
Current consumption	35 mA no-load
Maximum delay first up	200 ms
Maximum delay response	3.5 ms
Maximum delay recovery	2.5 ms
Net Weight	0.44 lb(US) (0.2 kg)

Environment

Product Certifications	CE CSA UL
Ambient Air Temperature for Operation	-13...131 °F (-25...55 °C)
Ambient Air Temperature for Storage	-40...158 °F (-40...70 °C)
Vibration resistance	7 gn 10...55 Hz) IEC 60068-2-6
Shock resistance	10 gn 11 ms) IEC 60068-2-27
IP degree of protection	IP30 IEC 60529 with cover open) IP65 IEC 60529 double insulation) IP67 IEC 60529 double insulation)

Ordering and shipping details

Category	22481-SENSORS, PHOTOELECTRIC
Discount Schedule	DS2
GTIN	3389119039888
Nbr. of units in pkg.	1
Package weight(Lbs)	6.77 oz (192.0 g)
Returnability	No
Country of origin	FR

Packing Units

Unit Type of Package 1	PCE
Package 1 Height	5.20 in (13.2 cm)
Package 1 width	3.70 in (9.4 cm)
Package 1 Length	1.65 in (4.2 cm)
Unit Type of Package 2	S02
Number of Units in Package 2	22
Package 2 Weight	10.41 lb(US) (4.724 kg)
Package 2 Height	5.91 in (15 cm)
Package 2 width	11.81 in (30 cm)
Package 2 Length	15.75 in (40 cm)

Offer Sustainability

Sustainable offer status	Green Premium product
California proposition 65	WARNING: This product can expose you to chemicals including: Diisononyl phthalate (DINP), which is known to the State of California to cause cancer, and Di-isodecyl phthalate (DIDP), which is known to the State of California to cause birth defects or other reproductive harm. For more information go to www.P65Warnings.ca.gov
REACH Regulation	REACH Declaration
EU RoHS Directive	Pro-active compliance (Product out of EU RoHS legal scope) EU RoHS Declaration
Mercury free	Yes
RoHS exemption information	Yes
Environmental Disclosure	Product Environmental Profile
Circularity Profile	End Of Life Information

Contractual warranty

Warranty	18 months
----------	-----------

Dimensions

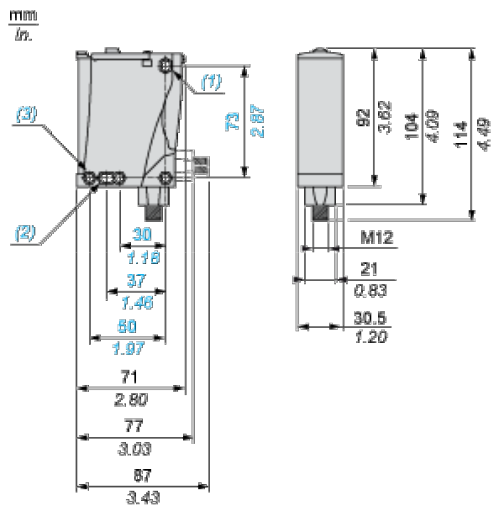

- (1) Elongated hole $\text{Ø } 5.5 \times 7$
- (2) Elongated hole $\text{Ø } 5.5 \times 9$
- (3) $\text{Ø } 5.5$ hole

Mounting and Clearance

Possible Orientation of Elbowed Connector (Rear View)

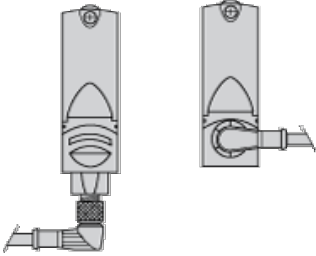

Wiring Schemes

M12 Connector

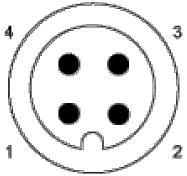

PNP/NPN DC

M12		Terminals		
1	●	1	⊘	+
3	●	2	⊘	-
4	●	3	⊘	Output
2	●	4	⊘	Alarm inactive

Detection Curves

Variation of Usable Sensing Distance S_u

Teach Mode at Minimum

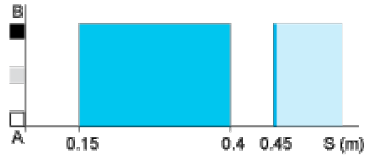

Teach Mode at Maximum

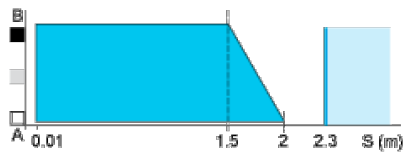

- (1) Black 6%
- (2) Grey 18%
- (3) White 90%
- (4) Sensing range
- (5) Non sensing zone (matt surfaces)

A-B : Object reflection coefficient

- (1) Black 6%
- (2) Grey 18%
- (3) White 90%
- (4) Sensing range
- (5) Non sensing zone (matt surfaces)

Detection Curves

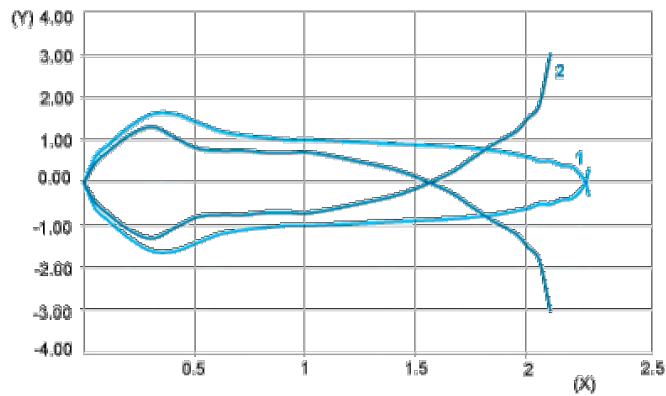

- 1 : White 90%
- 2 : Grey 18%
- (Y) Detection lobe (cm)
- (X) Object distance (m)

Object 10 x 10 cm

Relative Difference in Sensing Distances According to Object Colour

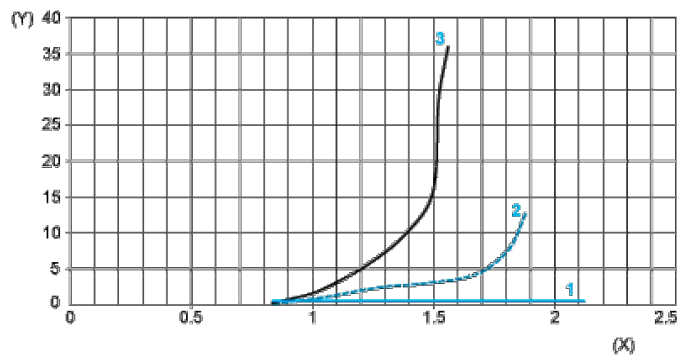

- 1 : White 90%
 - 2 : Grey 18%
 - 3 : Black 6%
 - (Y) Relative error (%)
 - (X) Object distance (m)
- Object 10 x 10 cm