

Title	<i>Reference Design Report for a 100 W 2-Stage Boost and Isolated Flyback Dimmable LED Ballast Using HiperPFS™-4 PFS7626C and LYTSwitch™-6 PowiGaN™ LYT6079C</i>
Specification	100 VAC – 277 VAC Input; 48 V, 2080 mA Output
Application	3-Way Dimming LED Ballast
Author	Applications Engineering Department
Document Number	RDR-801
Date	July 17, 2020
Revision	1.3

Summary and Features

- With integrated PFC function, PF >0.95, <10 % ATHD
- Accurate output voltage and current regulation, ±5%
- Very low ripple current, <10% of I_{OUT}
- Highly energy efficient, 90 % at 230 V
- Low cost and low component count for compact PCB solution
- 3-way dimming functions
 - 0 VDC - 10 VDC analog dimming
 - 10 V PWM signal (frequency range: 100 Hz to 3 kHz)
 - Variable resistance (0 to 100 kΩ)
- Integrated protection and reliability features
 - Output short-circuit
 - Line and output OVP
 - Line surge or line overvoltage
 - Over temperature shutdown with hysteretic automatic power recovery
- No damage during line brown-out or brown-in conditions
- Meets IEC 2.5 kV ring wave, 1 kV differential surge
- Meets EN55015 conducted EMI

Power Integrations

5245 Hellyer Avenue, San Jose, CA 95138 USA.
Tel: +1 408 414 9200 Fax: +1 408 414 9201
www.power.com

PATENT INFORMATION

The products and applications illustrated herein (including transformer construction and circuits external to the products) may be covered by one or more U.S. and foreign patents, or potentially by pending U.S. and foreign patent applications assigned to Power Integrations. A complete list of Power Integrations' patents may be found at www.power.com. Power Integrations grants its customers a license under certain patent rights as set forth at <https://www.power.com/company/intellectual-property-licensing/>.



Table of Contents

1	Introduction.....	6
2	Power Supply Specification	8
3	Schematic.....	9
4	Circuit Description.....	13
4.1	Input EMI Filter and Rectifier.....	13
4.2	First Stage: Boost PFC Using HiperPFS-4.....	14
4.2.1	Input Feed Forward Sense Circuit	16
4.2.2	PFC Output Feedback.....	16
4.2.3	Bias Supply Series Regulator.....	16
4.3	Second Stage: Isolated Flyback DC-DC Using LYTSwitch-6.....	17
4.4	3-Way Dimming Control Circuit.....	20
4.4.1	0 VDC – 10 VDC Dimming	20
4.4.2	Variable Duty PWM Input (10 V Peak)	21
4.4.3	Variable Resistance (0 Ω – 100 k Ω)	21
5	PCB Layout.....	23
6	Bill of Materials	24
6.1	Main BOM	24
6.2	Miscellaneous Parts.....	26
7	PFC Inductor Specification (T4).....	27
7.1	Electrical Diagram.....	27
7.2	Electrical Specifications	27
7.3	Material List	27
7.4	PFC Inductor Build Diagram	28
7.5	PFC Inductor Construction.....	28
7.6	Winding Illustrations	29
8	Transformer Specification (T3).....	31
8.1	Electrical Diagram.....	31
8.2	Electrical Specifications	31
8.3	Material List	31
8.4	Transformer Build Diagram	32
8.5	Transformer Construction.....	32
8.6	Winding Illustrations	33
9	Input Common Mode Choke Specification (L1).....	36
9.1	Electrical Diagram.....	36
9.2	Electrical Specifications	36
9.3	Material List	36
9.4	Winding Instructions	37
10	Output Common Mode Choke Specification (L3).....	38
10.1	Electrical Diagram.....	38
10.2	Electrical Specifications	38
10.3	Material List	38
10.4	Winding Instructions	39
11	Design Spreadsheet	40



11.1	HiperPFS-4 Design Spreadsheet.....	40
11.2	LYTSwitch-6 Design Spreadsheet.....	45
12	Heat Sink Assembly.....	48
12.1	Heat Sink Fabrication Drawing.....	48
12.2	Heat Sink Fabrication Drawing.....	49
12.3	Heat Sink and Assembly Drawing.....	50
13	Performance Data.....	51
13.1	CV/CC Output Characteristic Curve.....	51
13.2	System Efficiency.....	52
13.3	Output Current Regulation.....	53
13.4	Power Factor.....	54
13.5	%ATHD.....	55
13.6	Individual Harmonic Content at 48 V LED Load.....	56
13.7	No-Load Input Power.....	58
14	Test Data.....	59
14.1	48 V LED Load.....	59
14.2	42 V LED Load.....	59
14.3	36 V LED Load.....	60
14.4	No-Load.....	60
14.5	Individual Harmonic Content at 120 VAC and 48 V LED Load.....	61
14.6	Individual Harmonic Content at 230 VAC and 48 V LED Load.....	62
15	Dimming Performance.....	63
15.1	Dimming Curve.....	63
15.1.1	0 V - 10 V Dimming Curve.....	63
15.1.2	10 V 1 kHz PWM Dimming Curve.....	65
15.1.3	Variable Resistor Dimming Curve.....	67
16	Thermal Performance.....	69
16.1	Thermal Scan at 25 °C Ambient.....	69
16.1.1	Thermal Scan at 100 VAC Full Load.....	70
16.2	Thermal Performance at 40 °C Ambient.....	71
17	Waveforms.....	72
17.1	Input Voltage and Input Current at 48 V LED Load.....	72
17.2	Start-up Profile at 48 V LED Load.....	73
17.3	Start-up Profile at 36 V LED Load.....	74
17.4	Output Current Fall at 48 V LED Load.....	75
17.5	Output Current Fall at 36 V LED Load.....	76
17.6	PFS7626C (U2) Drain Voltage and Current at Normal Operation.....	77
17.7	PFS7626C (U2) Drain Voltage and Current at Start-up.....	79
17.8	LYTSwitch-6 (U4) Drain Voltage and Current at Normal Operation.....	80
17.9	LYTSwitch-6 (U4) Drain Voltage and Current at Start-up.....	83
17.10	LYTSwitch-6 (U4) Drain Voltage and Current during Output Short-Circuit.....	85
17.11	Input Power during Output Short-Circuit.....	87
17.12	Output Voltage and Current at Open Output LED Load.....	88
17.13	Output Voltage and Current – Start-up at Open Output Load.....	88



17.14	Output Ripple Current at Full load.....	89
17.15	Output Ripple Current at 36 V LED Load	90
18	AC Cycling Test at 48 V LED Load	91
19	AC Cycling Test at 36 V LED Load	92
20	Conducted EMI	93
20.1	Test Set-up	93
20.2	Equipment and Load Used.....	93
20.2.1	EMI Test Results	94
21	Line Surge.....	96
21.1	Differential Surge Test Results.....	96
21.2	Ring Wave Surge Test Results	96
21.3	1 kV Differential Surge Test at 115 VAC	97
21.4	1 kV Differential Surge Test at 230 VAC	98
21.5	2.5 kV Ring Wave Surge Test at 115 VAC.....	100
21.6	2.5 kV Ring Wave Surge Test at 230 VAC.....	101
22	Brown-in/Brown-out Test	103
23	Revision History	104

Important Note: Although this board is designed to satisfy safety isolation requirements, the engineering prototype has not been agency approved. Therefore, all testing should be performed using an isolation transformer to provide the AC input to the prototype board.

1 Introduction

This engineering report describes a 100 W LED ballast with 3-way dimming function. The LED ballast is designed to provide a 48 V output voltage across 0 mA to 2080 mA output current load with 3-way dimmable constant current at 48 V – 36 V LED voltage string. The design is optimized to operate from an input voltage range of 100 VAC to 277 VAC.

The key design goals were low component count, high power factor, low THD, and high efficiency. The document contains the power supply specification, schematic, bill of materials, transformer documentation, printed circuit layout, and performance data.

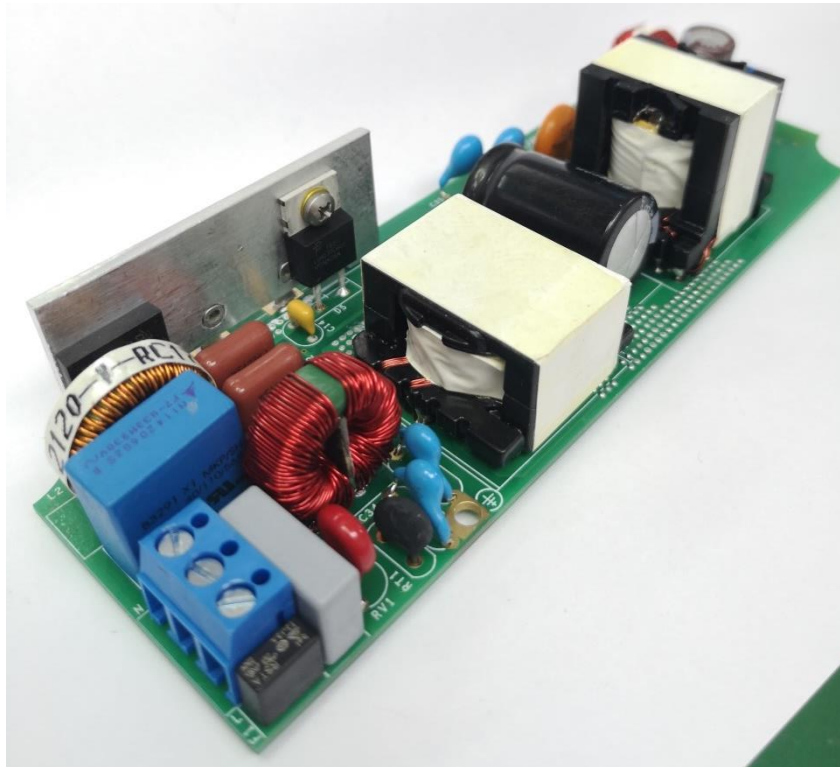

Figure 1 – Populated Circuit Board.

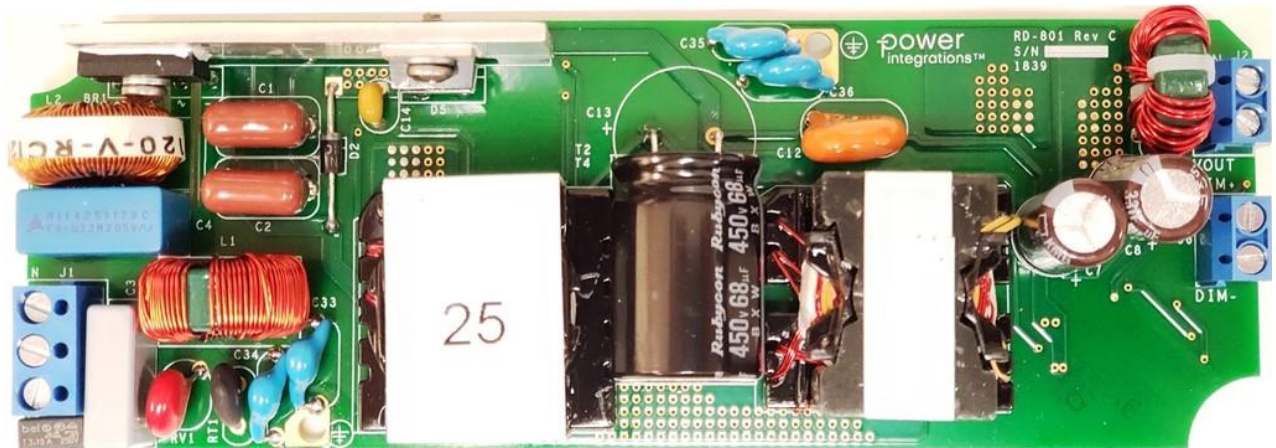

Figure 2 – Populated Circuit Board, Top View.

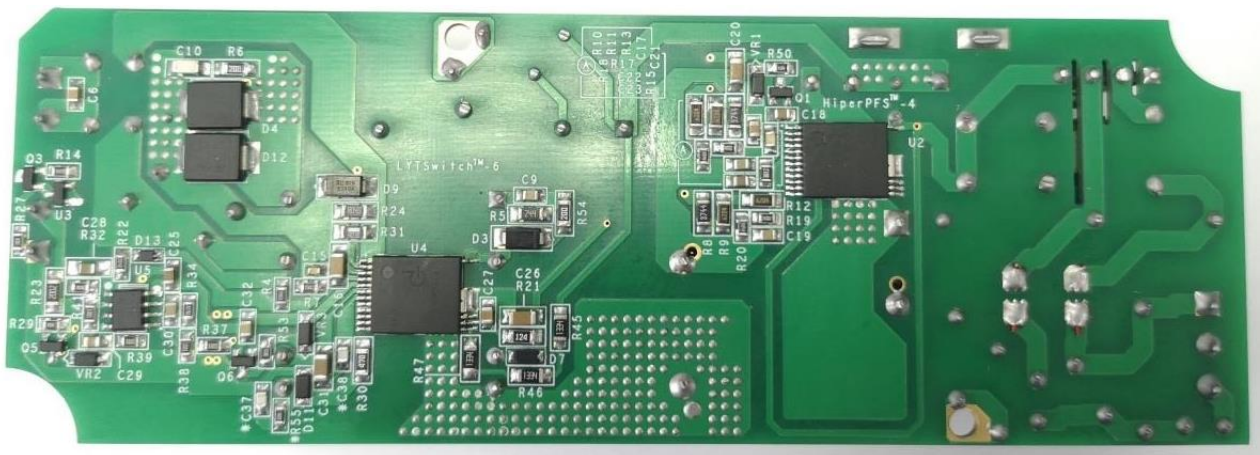

Figure 3 – Populated Circuit Board, Bottom View.

2 Power Supply Specification

The table below represents the minimum acceptable performance of the design. Actual performance is listed in the results section.

Description	Symbol	Min	Typ	Max	Units	Comment
Input						
Voltage	V_{IN}	100	115 / 60	277	VAC / Hz	2-Wire Floating Output or 3-Wire with P.E.
Frequency	f_{LINE}		230 / 50 277 / 60			
Output						
Output Voltage	V_{OUT}		48		V	±5%
Output Current	I_{OUT}	1976	2080	2184	mA	
Total Output Power						
Continuous Output Power	P_{OUT}		99.84		W	
Efficiency						
Full Load	η		90		%	230 V / 50 Hz at 25 °C.
Environmental						
Conducted EMI			CISPR 15B / EN55015B			
Safety			Isolated			
Ring Wave (100 kHz)			2.5		kV	
Differential Mode (L1-L2)			1.0		kV	
Power Factor			0.95			Measured at 115 V / 60 Hz, 230 VAC / 50 Hz and 277 V / 60 Hz.
ATHD			10		%	Measured at 115 V / 60 Hz, 230 VAC / 50 Hz and 277 V / 60 Hz.
Ambient Temperature	T_{AMB}		30		°C	Free Air Convection, Sea Level.

3 Schematic

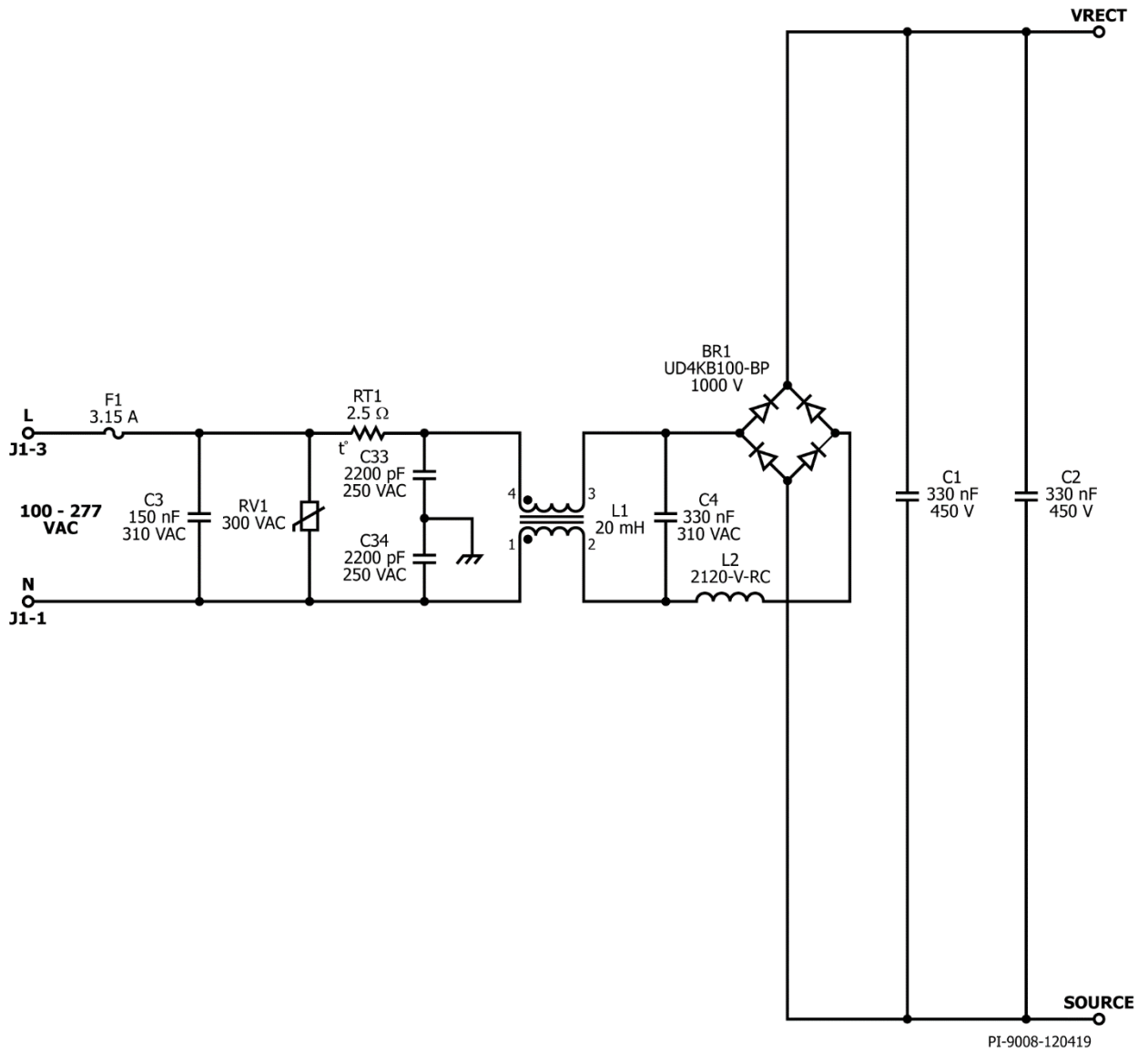

Figure 4 – Schematic, Input Section.

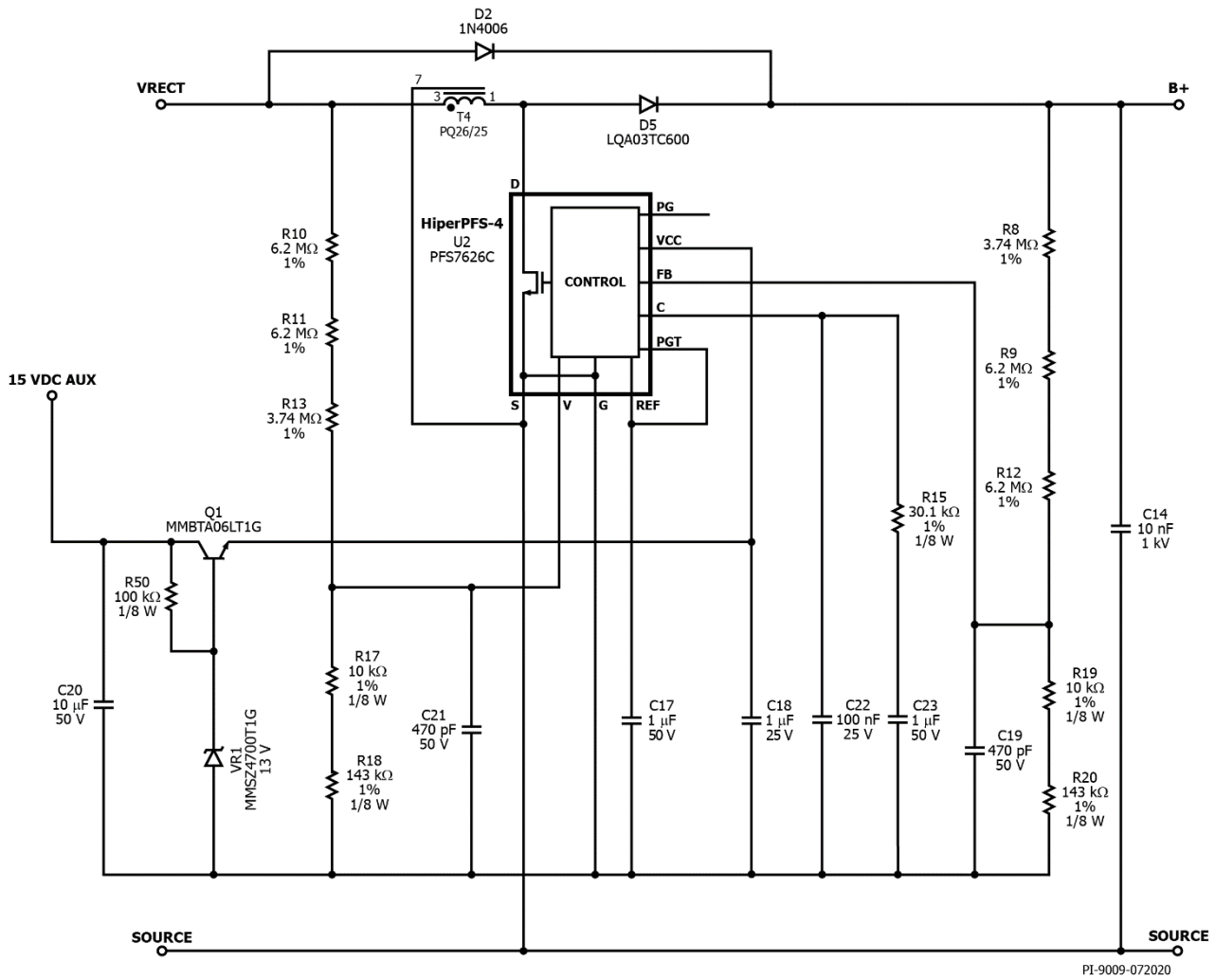

Figure 5 – Schematic, PFC Section.

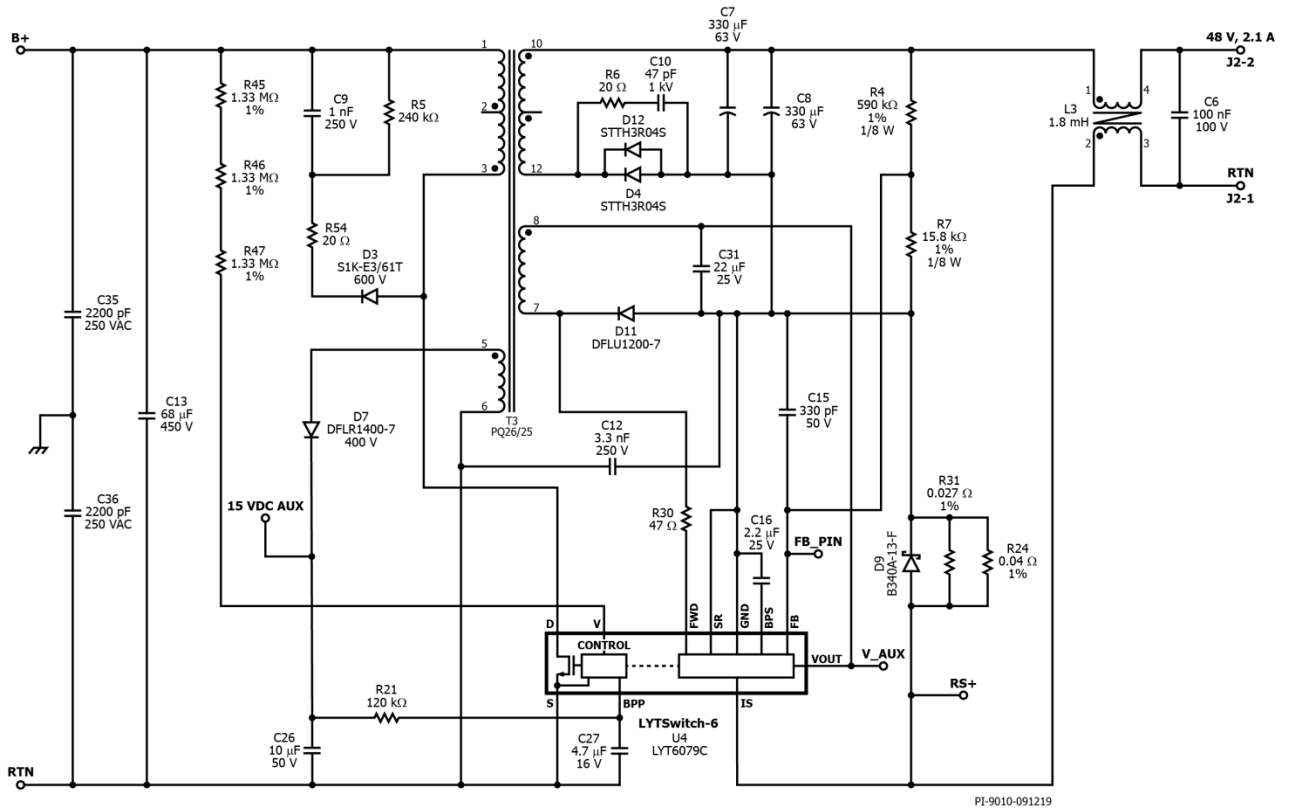

Figure 6 – Schematic, Power Section.



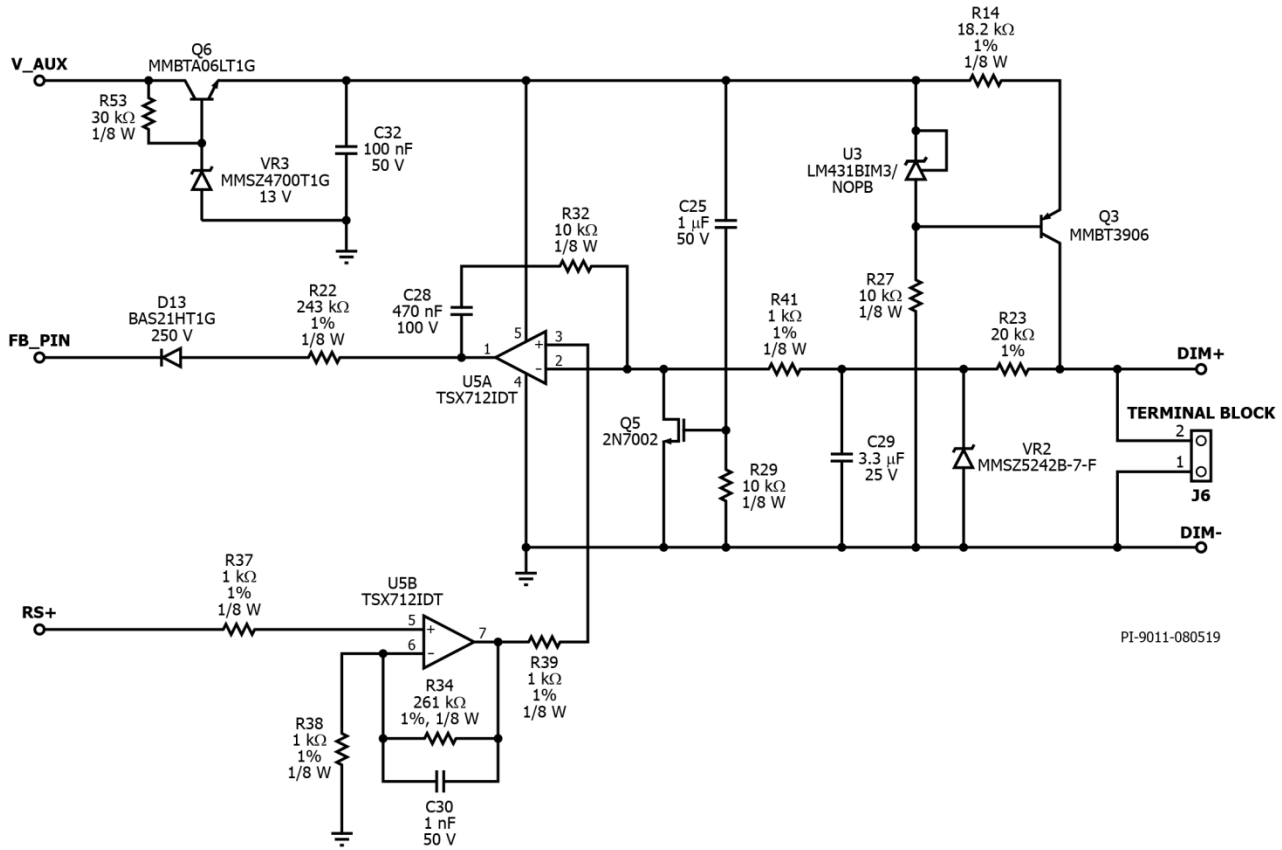

Figure 7 – Schematic, Dimming Section.

4 Circuit Description

The 100 W LED ballast design utilizes two highly integrated devices for a high power factor, low THD, and efficient two-stage power supply. The ballast also includes a 3-way dimming functionality. The first stage is a PFC boost driver using PFS7626C from the HiperPFS-4 family. The second stage is an isolated flyback DC-DC power supply using LYT6079C from LYTSwitch-6 devices.

The HiperPF-4 devices incorporate a continuous conduction mode (CCM) boost PFC controller, gate driver, and 600 V power MOSFET in an InSOP-24D package. PFS7626C eliminates external current sense resistors and uses an innovative control technique varying the switching frequency over output load, input line voltage, and input line cycle. HiperPFS-4 technology maximizes the efficiency in the full range of load even at light load.

LYTSwitch-6 devices integrate the primary FET, the primary-side control, and the secondary-side synchronous rectification control also in an InSOP-24D package. LYT6079C FluxLink technology safely bridges the isolation barrier and eliminates the use of an optocoupler.

4.1 Input EMI Filter and Rectifier

The input fuse F1 provides safety protection. Varistor RV1 acts as a voltage clamp that limits the voltage spike on the primary during line transient voltage surge events. NTC thermistor RT1 is added to limit the inrush current during startup and to prevent saturation of PFC inductor T2. The AC input voltage is full wave rectified by BR1 to achieve good power factor and low THD.

Capacitors C1, C2 and L2 and C4 form a Pi filter together with C3 which suppress differential-mode noise. Common mode noise is suppressed by common-mode choke L1 together with Y capacitor C33 and C34. Additional Y capacitors, C35 and C36 across the bulk capacitor, and output common-mode choke L3 for earth wire connection, suppress common-mode noise.

4.2 First Stage: Boost PFC Using HiperPFS-4

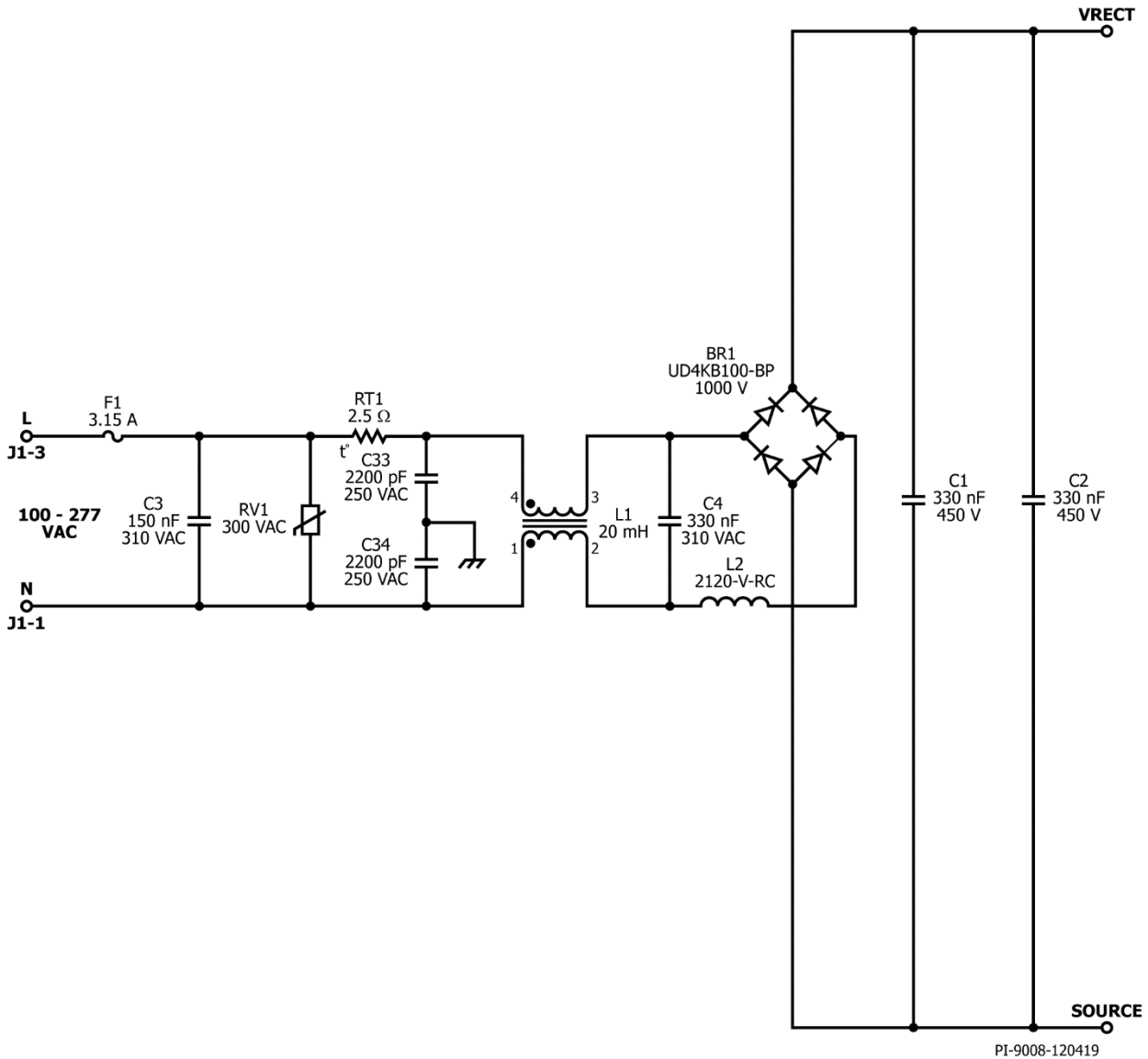

Figure 8 – Schematic, Input Section.

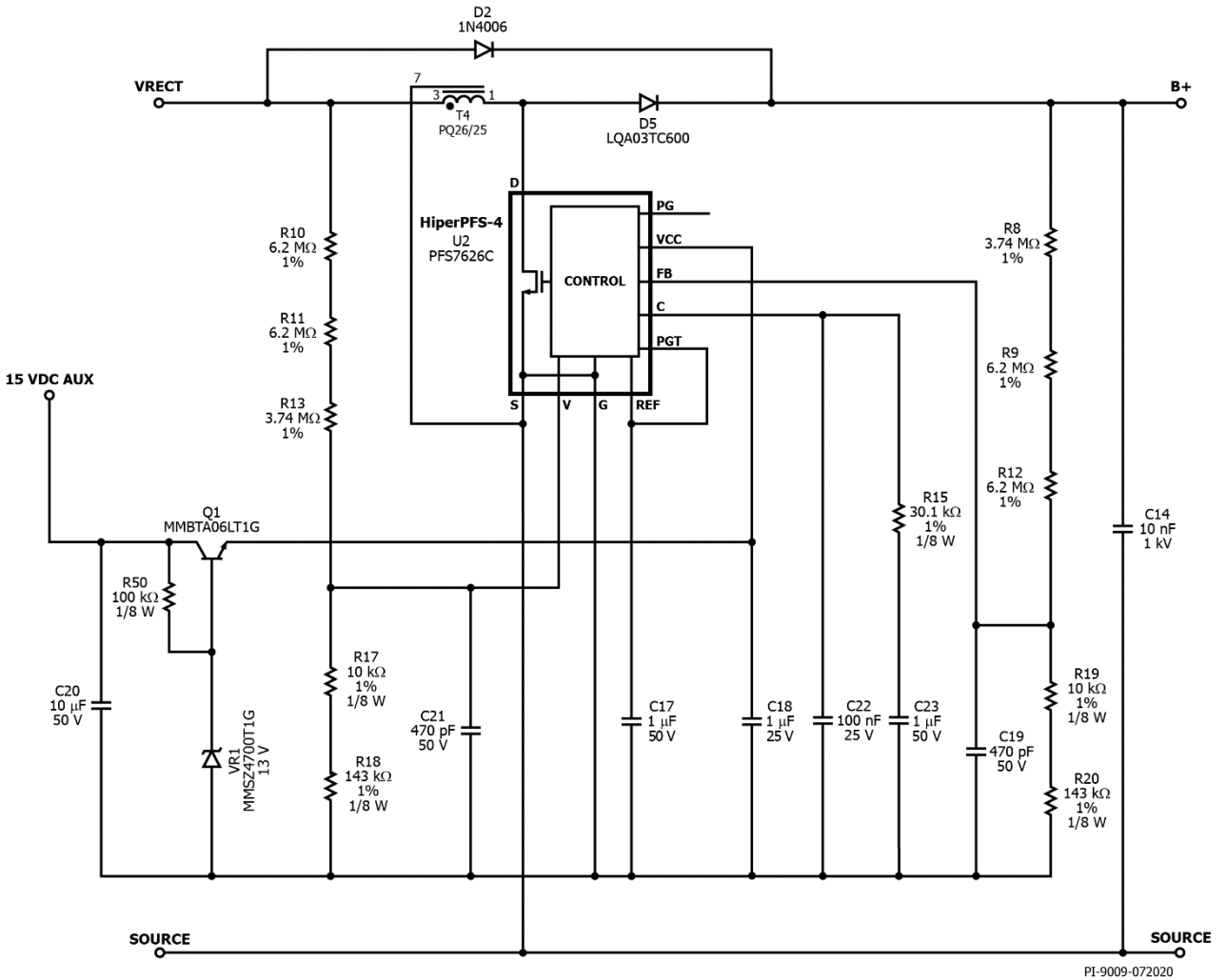

Figure 9 – Schematic, PFC Section.

The PFC converter stage consists of the boost inductor T4 and the PFS7626C IC U2. The PFC boost converter maintains a sinusoidal input current to the power supply while regulating a 410 VDC output PFC voltage. Boost diode D5 from Q-speed Q-Series LQA03TC600 is used as cost-effective solution to balance EMI performance and switching speed of boost topology.

During start-up, diode D2 provides an inrush current path to the PFC output capacitor C13, bypassing the switching inductor T2/T4 and switch U2 in order to prevent a resonant interaction between the switching inductor and PFC output capacitor.

Capacitor C14 provides a short loop, high-frequency return path to RTN for improved EMI performance and to reduce U2 drain voltage overshoot during turn-off. The POWER GOOD THRESHOLD (PGT) pin is disabled by connecting to REFERENCE (REF) pin and with POWER GOOD (PG) pin left unconnected. This feature can be enabled by adding a resistor to program the threshold of PFC output level and to toggle PG pin to high-



impedance state. Capacitor C17 on the REF pin of U2 is a noise-decoupling element for the internal reference. C17 also programs the output power for either full mode, 100% of rated power [C17 = 1 μ F] or efficiency mode, 80% [C17 = 0.1 μ F] of rated power. DER-801 utilizes 'full' power mode to optimize the device performance.

4.2.1 Input Feed Forward Sense Circuit

The input voltage of the power supply is sensed by the PFS7626C U2 via resistors R10, R11, R13, R17 and R18. The capacitor C21 is an external bypass for the VOLTAGE (V) pin of U2.

4.2.2 PFC Output Feedback

A resistive divider network, R8, R9, R12, R19 and R20, at PFC output voltage provides a scaled voltage proportional to PFC voltage as feedback to the PFS7626C controller U2 to set the output of PFC at 410 V. Capacitor C19 decouples the U2 FEEDBACK (FB) pin. Resistor R15 and capacitor C23 at COMPENSATION (C) pin provide the control loop dominant pole. An additional capacitor C22 attenuates high-frequency noise.

4.2.3 Bias Supply Series Regulator

The PFS7626C U2 requires a regulated VCC supply of 12 V nominal for operation. A bias voltage input of +37 V DC supply is provided by the auxiliary winding at the DC-DC stage which also supplies the BPP pin for LYTSwitch-6 at second-stage. A high bias voltage of 37 V is selected to improve deep CV/CC operation maintaining a high power factor – PFC stage still operating. At 10V during CV/CC, PFC is bypassed via the inrush diode D2 with the input voltage supplying the second-stage only. The power factor at this point is around 0.5 with PFC already disabled.

Resistor R50, Zener diode VR1, and transistor Q1 form a series regulator which supplies voltage to VCC pin to 13 V nominal. Exceeding the voltage in VCC pin, absolute maximum rating of 15 V, might cause damage to the IC. Capacitor C18 decouples the input supply voltage to ensure reliable operation of the device. Capacitor C20 filters the bias voltage input.

4.3 Second Stage: Isolated Flyback DC-DC Using LYTSwitch-6

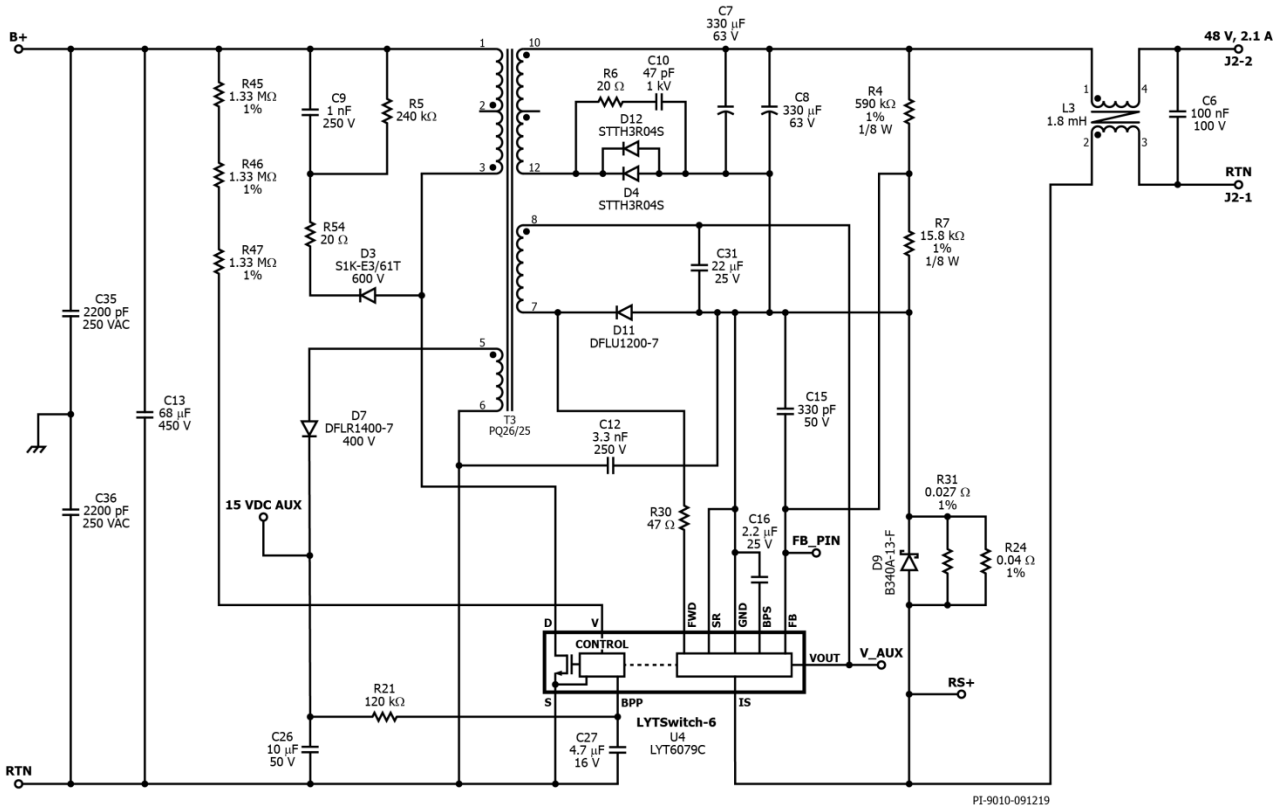

Figure 10 – Schematic, Power Section.

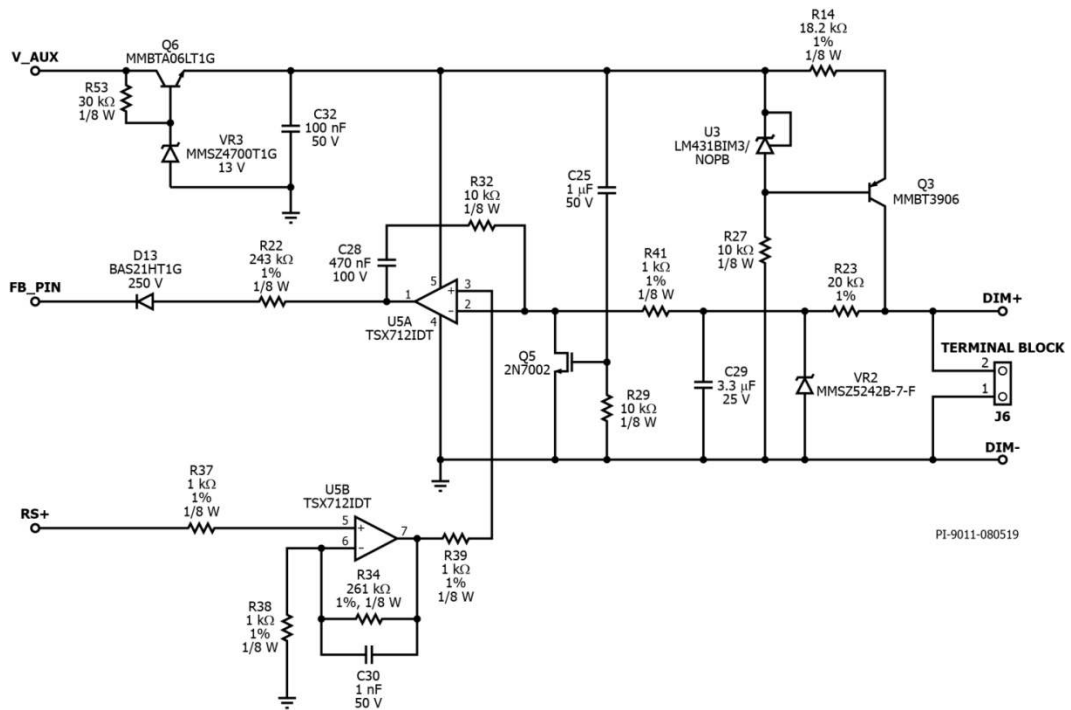

Figure 11 – Schematic, Dimming Section.



The second stage circuit topology is an isolated flyback DC-DC power supply controlled by the LYTSwitch-6 IC (U4). One side of the transformer (T3) primary is connected to the positive output terminal of the PFC while the other side is connected to 750 V power MOSFET integrated in LYTSwitch-6 device (U4). A low cost RCD clamp formed by D3, R54, R5, and C9 limits the peak drain voltage spike due to the effect of transformer leakage inductance.

The VOLTAGE MONITOR (V) pin of LYTSwitch-6 IC senses the input voltage from PFC stage thru resistors R45, R46, and R47.

During start-up when PFC output voltage is first applied from the inrush diode D2, an internal high-voltage current source charges the BPP pin capacitor (C27). During normal operation, the primary side block is powered by the auxiliary winding of the transformer. The auxiliary winding is configured as a flyback, rectified and filtered (D7 and C26) and fed to the BPP pin via a current limiting resistor R21. Output regulation is achieved by controlling the switching duty cycle.

The secondary-side controller sets the output voltage and the output current sensing. The secondary winding is rectified by ultrafast recovery diodes D4 and D12 and then filtered by output capacitors C7 and C8. A snubber RC network R6 and C10 suppresses high-frequency voltage spike across the output diodes during switching.

The secondary-side of the IC is powered from the secondary bias winding which is rectified by D11 and filtered by C31. During CV operation the rectified secondary bias supply voltage powers the device which is fed into the VO pin. The FORWARD (FWD) pin connects to the secondary auxiliary winding to reduce its voltage stress.

The output voltage 48 V is sensed via resistor divider R4 and R7 with a reference voltage of 1.265 V on the FB pin during output voltage regulation. Filter capacitor C15 is added across the lower feedback resistor to filter unwanted noise which might trigger OVP function or increase output ripple.

During start-up or short-circuit operation, where the output voltage is low, the SECONDARY BYPASS (BPS) pin is powered through the secondary bias winding forward voltage via R30 and an internal regulator.

During CC operation, output current is sensed externally via sense resistors R24 and R31 between IS and GND pins. When the internal current sense IS pin threshold of 35.9 mV is exceeded, the device regulates the output current by varying its switching frequency. Schottky diode D9 serves as a clamp during output short-circuit protecting the IS pin from overvoltage stress.

The secondary bias supply also provides power for the 3-way dimming circuit. The rectified bias winding supplies the series regulator, VR3, R53, Q6 and C32, with a regulated 13 V output to the dimming circuit.



4.4 3-Way Dimming Control Circuit

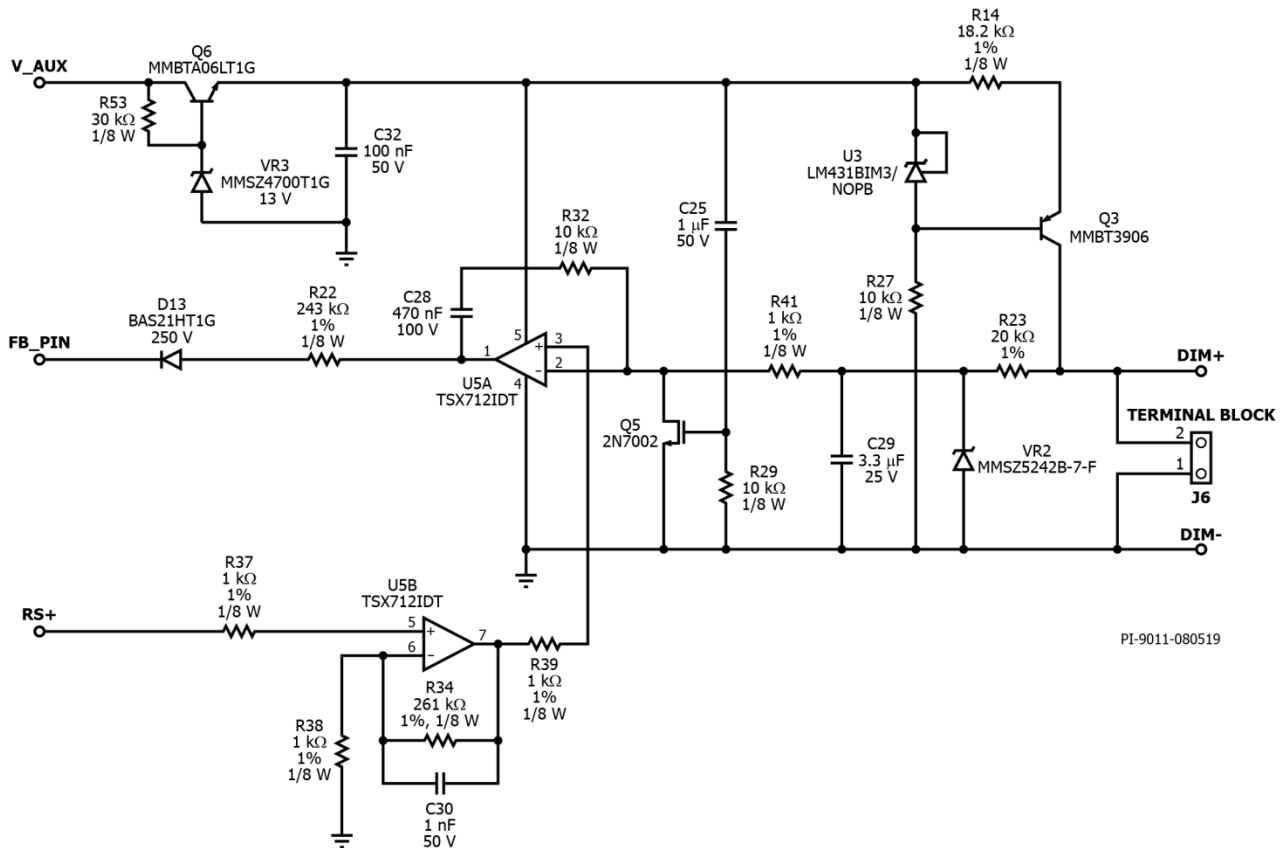

Figure 12 – 3-Way Dimming Schematic.

The 3-way dimming control circuit is shown in Figure 10. DIM+ and DIM- are input terminals for three ways of dimming the LED output. Through IS pin, output current from RTN terminal is sensed through R24 and R31 resistors. The voltage signal of these resistors is the input to the non-inverting amplifier U5B. The gain is set at around 261 through R37, R38, and R34 with resulting voltage of around 9 V at full-scale output current. The output of U5B is also the non-inverting input of U5A through R39. The inverting input (pin 2) is supplied with the dimming input type: (1) variable DC supply (0 V – 10 V), (2) variable resistance (0 Ω – 100 k Ω), or (3) variable duty PWM signal (0% – 100%, 100 kHz – 3 kHz).

The output of U5B which is the non-inverting input of U5A, will always try to match the inverting input of U5A or the dimming input profile.

4.4.1 0 VDC – 10 VDC Dimming

When a DC voltage is applied across DIM+ to DIM-, C29 will be charged up to this voltage level via R23. The DC supply at the dimming input terminals is just equal to the voltage at the inverting terminal (pin 2) of U5A. The DC voltage DIM input is proportional to the output current since U5B is designed as non-inverting. Increasing this voltage will

result to increase in output current. The dimming input range is from 0 V to 10 V – applying 0 V will result to minimum output current while applying 10 V will result to maximum output current.

4.4.2 Variable Duty PWM Input (10 V Peak)

When a PWM signal is applied across DIM+ to DIM-, the averaging filter R23 and C29 will result to voltage equal to the inverting (pin 2) terminal of U5A. This voltage is proportional to the PWM duty cycle.

$$V_{- \text{ of U5A}} = D * V_{PEAK}$$

Where:

V- of U5A – voltage at the inverting pin of U5A

D – PWM duty cycle

V_{PEAK} – max. voltage of the PWM signal

The maximum voltage of the PWM input is at 10 V_{PK} and the minimum frequency set at 100 Hz. Resistor R23 and C29 are selected so that the time constant (RC) is much greater than the period of the minimum PWM frequency for better filtering.

4.4.3 Variable Resistance (0 Ω – 100 kΩ)

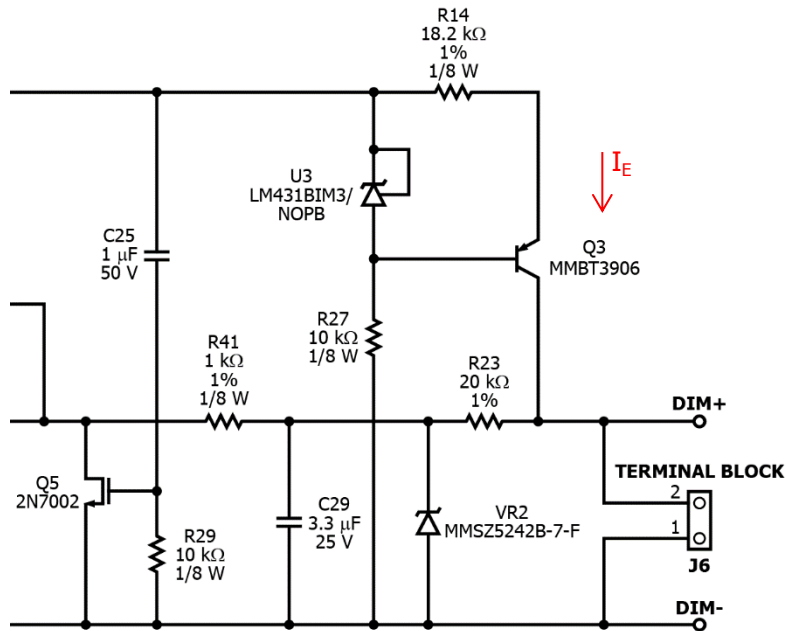

PI-9011-080519

Figure 13 – Blanking Circuit and Constant Current Schematic.

A constant current source circuit R14, R27, U3, and Q3 converts the variable resistance (0 Ω – 100 kΩ) input into variable DC signal (0 V – 10 V). U3 clamps the voltage at R14, to set the emitter current at a constant value. The emitter current of Q3 is almost



equal to its collector current, $\sim 100 \mu\text{A}$, supplying the variable resistance input which results to 0 V – 10 V needed at inverting input (pin 2) of U5A. Zener diode VR2 serves as protection when the dimming input is interchanged by the user.

During start-up, the initial output of U5 is low which results to unwanted spike in output current seen in LED string. To eliminate this spike, a blanking circuit Q5, R29, and C25 is added to the dimming circuit which initially pulls down the inverting input (pin 2) so that U5 output is set at high.

The op-amp output (pin 1) is connected to the FB pin through D13 and R22. The variable output of op-amp which is dependent to DIM input sets the current injected into the FB pin. The feedback voltage will increase as current is injected. This current injection will result to decreasing V_{OUT} when in normal CV mode, but since the LED load is a constant voltage, decrease will be seen in the output current instead.

The current injection loop may trigger feedback overvoltage with stepping the load from 100% to 0% during dimming. In order to avoid this, R22 is increased to slow down the current injection.

A low-input offset operational amplifier is recommended to reduce unit-to-unit variability. It is also important to note that the dimming circuit should be close to IS pin and FB pin to prevent noise coupling in the loop.

5 PCB Layout

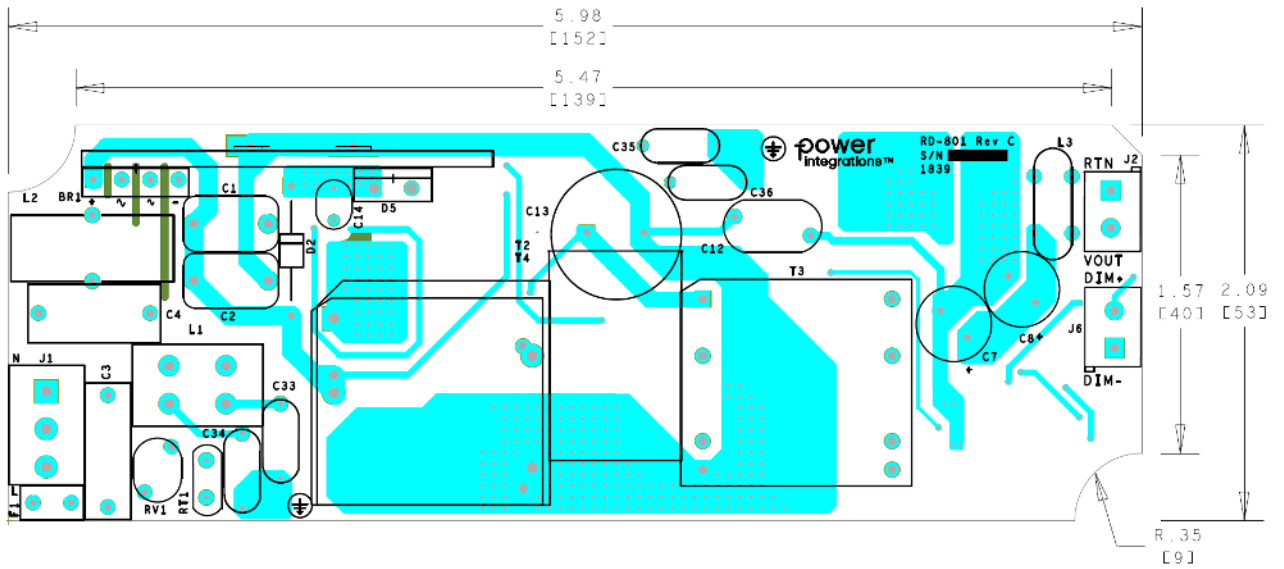

Figure 14 – Top Side.

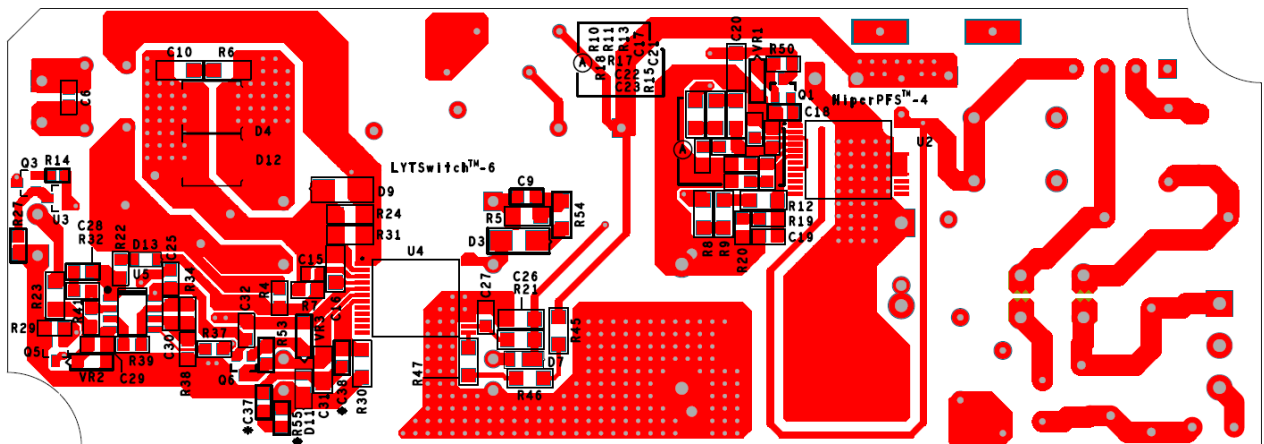

Figure 15 – Bottom Side.



6 Bill of Materials

6.1 Main BOM

Item	Qty	Ref Des	Description	Mfg Part Number	Mfg
1	1	BR1	Bridge Rectifier, 1000 V, 4 A, 4-ESIP, D3K, -55°C ~ 150°C (TJ), Vf = 1 V @ 7.5 A	UD4KB100-BP	Micro Commercial
2	1	C1	330 nF, 450 V, METALPOLYPRO	ECW-F2W334JAJQ	Panasonic
3	1	C2	330 nF, 450 V, METALPOLYPRO	ECW-F2W334JAJQ	Panasonic
4	1	C3	150 nF, 310 VAC, X2	BFC233820154	Vishay
5	1	C4	330 nF, 310 VAC, Film, X2	B32922C3334M	Epcos
6	1	C6	100 nF 100V 10 % X7R 0805	C0805C104K1RACTU	Kemet
7	1	C7	330 µF, 63 V, Electrolytic, (10 x 20)	EKMG630ELL331MJ20S	United Chemi-con
8	1	C8	330 µF, 63 V, Electrolytic, (10 x 20)	EKMG630ELL331MJ20S	United Chemi-con
9	1	C9	1 nF, 250 V, Ceramic, X7R, 0805	GRM21AR72E102KW01D	Murata
10	1	C10	47 pF, 1000 V, Ceramic, NPO, 1206	C1206C470JGACTU	Kemet
11	1	C12	3.3 nF, Ceramic, Y1	440LD33-R	Vishay
12	2	C13	68 µF, 20%, 450 V, Electrolytic, 10000 Hrs @ 105°C, (18 x 25)	450BXW68MEFC18X25	Rubycon
13	1	C14	10 nF, 1 kV, Disc Ceramic, X7R	SV01AC103KAR	AVX
14	1	C15	330 pF 50 V, Ceramic, X7R, 0603	CC0603KRX7R9BB331	Yageo
15	1	C16	2.2 µF, 25 V, Ceramic, X7R, 1206	TMK316B7225KL-T	Taiyo Yuden
16	1	C17	1 µF, ±10%, 50 V, Ceramic, X7R, AEC-Q200, Automotive, Boardflex Sensitive, 0805, -55°C ~ 125°C	CGA4J3X7R1H105K125AE	TDK
17	1	C18	1 µF, ±10%, 25 V, Ceramic, X7R, 0805	GCM21BR71E105KA56L	Murata
18	1	C19	470 pF, 50 V, Ceramic, X7R, 0805	CC0805KRX7R9BB471	Yageo
19	1	C20	10 µF, 10%, 50V, Ceramic, X7R, -55°C ~ 125°C, 1206, 0.126" L x 0.063" W (3.20 mm x 1.60 mm)	CL31B106KBHNNNE	Samsung
20	1	C21	470 pF, 50 V, Ceramic, X7R, 0805	CC0805KRX7R9BB471	Yageo
21	1	C22	100 nF, 25 V, Ceramic, X7R, 0805	08053C104KAT2A	AVX
22	1	C23	1 µF, ±10%, 50 V, Ceramic, X7R, AEC-Q200, Automotive, Boardflex Sensitive, 0805, -55°C ~ 125°C	CGA4J3X7R1H105K125AE	TDK
23	1	C25	1 µF, ±20%, 50 V, Ceramic, X7R, AEC-Q200, Automotive, Boardflex Sensitive, 0805	CGA4J3X7R1H105M125AE	TDK
24	1	C26	10 µF, 10%, 50 V, Ceramic, X7R, -55°C ~ 125°C, 1206, 0.126" L x 0.063" W (3.20 mm x 1.60 mm)	CL31B106KBHNNNE	Samsung
25	1	C27	4.7 µF, 16 V, Ceramic, X7R, 0805	CL21B475KOFNNNE	Samsung
26	1	C28	0.47 µF, 100 V, Ceramic, X7R, 1206	C3216X7R2A474K	TDK
27	1	C29	3.3 F, 25 V, Ceramic, X7R, 0805	C2012X7R1E335K	TDK
28	1	C30	1 nF, 50 V, Ceramic, X7R, 0805	08055C102KAT2A	AVX
29	1	C31	22 µF, 25 V, Ceramic, X5R, 1206	GRM31CR61E226KE15L	Murata
30	1	C32	100 nF, 50 V, Ceramic, X7R, 0805	CC0805KRX7R9BB104	Yageo
31	1	C33	2200 pF, ±20%, 250 VAC, X1, Y1, Disc Ceramic	DE1E3KX222MN4AN01F	Murata
32	1	C34	2200 pF, ±20%, 250 VAC, X1, Y1, Disc Ceramic	DE1E3KX222MN4AN01F	Murata
33	1	C35	2200 pF, ±20%, 250 VAC, X1, Y1, Disc Ceramic	DE1E3KX222MN4AN01F	Murata
34	1	C36	2200 pF, ±20%, 250 VAC, X1, Y1, Disc Ceramic	DE1E3KX222MN4AN01F	Murata
35	1	C37	100 pF, 200 V, Ceramic, COG, 0805	08052A101JAT2A	AVX
36	1	C38	100 pF, 200 V, Ceramic, COG, 0805	08052A101JAT2A	AVX
37	1	D2	800 V, 1 A, GP, Rectifier, DO-41	1N4006-E3/54	Vishay
38	1	D3	800 V, 1 A, DO214AC	S1K-E3/61T	Vishay
39	1	D4	400 V, 3 A, Fast Recovery =< 500 ns, > 200 mA (Io), DO-214AB, SMC	STTH3R04S	ST Micro
40	1	D5	600 V, 3 A, TO-220AC	LQA03TC600	Power Integrations
41	1	D7	400 V, 1 A, Rectifier, Glass Passivated, POWERDI123	DFLR1400-7	Diodes, Inc.
42	1	D9	DIODE, SCHOTTKY, 40 V, 3 A, SMA, DO-214AA	B340A-13-F	Diodes, Inc.
43	1	D11	DIODE, UFASST, 200 V, 1 A, POWERDI123	DFLU1200-7	Diodes, Inc.
44	1	D12	400 V, 3 A, Fast Recovery =< 500ns, > 200 mA (Io), DO-	STTH3R04S	ST Micro



			214AB, SMC		
45	1	D13	Diode, General Purpose, Power, Switching, SS SWCH DIO, 250 V, SC-76, SOD-323	BAS21HT1G	ON Semi
46	1	F1	3.15 A, 250V, Slow, RST	507-1181	Belfuse
47	1	L1	20 mH, Common Mode Choke custom DER 801	30-04099-00	Power Integrations
48	1	L2	470 μ H, 1.6 A, Vertical Toroidal	2120-V-RC	Bourns
49	1	L3	Toroidal Common Mode Choke, 1.8 mH, CUSTOM, DER 801	32-00375-00	Power Integrations
50	1	Q1	NPN, Small Signal BJT, 80 V, 0.5 A, SOT-23	MMBTA06LT1G	On Semi
51	1	Q3	PNP, Small Signal BJT, 40 V, 0.2 A, SOT-23	MMBT3906LT1G	On Semi
52	1	Q5	60 V, 115 mA, SOT23-3	2N7002-7-F	Diodes, Inc.
53	1	Q6	NPN, Small Signal BJT, 80 V, 0.5 A, SOT-23	MMBTA06LT1G	On Semi
54	1	R4	RES, 590 k Ω , 1%, 1/8 W, Thick Film, 0805	ERJ-6ENF5903V	Panasonic
55	1	R5	RES, 240 k Ω , 5%, 1/4 W, Thick Film, 1206	ERJ-8GEYJ244V	Panasonic
56	1	R6	RES, 20 Ω , 5%, 1/4 W, Thick Film, 1206	ERJ-8GEYJ200V	Panasonic
57	1	R7	RES, 15.8 k Ω , 1%, 1/8 W, Thick Film, 0805	ERJ-6ENF1582V	Panasonic
58	1	R8	RES, 3.74 M Ω , 1%, 1/4 W, Thick Film, 1206	CRCW12063M74FKEA	Vishay
59	1	R9	RES, 6.2 M Ω , 1%, 1/4 W, Thick Film, 1206	KTR18EzPF6204	Rohm
60	1	R10	RES, 6.2 M Ω , 1%, 1/4 W, Thick Film, 1206	KTR18EzPF6204	Rohm
61	1	R11	RES, 6.2 M Ω , 1%, 1/4 W, Thick Film, 1206	KTR18EzPF6204	Rohm
62	1	R12	RES, 6.2 M Ω , 1%, 1/4 W, Thick Film, 1206	KTR18EzPF6204	Rohm
63	1	R13	RES, 3.74 M Ω , 1%, 1/4 W, Thick Film, 1206	CRCW12063M74FKEA	Vishay
64	1	R14	RES, 18.2 k Ω , 1%, 1/8 W, Thick Film, 0805	ERJ-6ENF1822V	Panasonic
65	1	R15	RES, 30.1 k Ω , 1%, 1/8 W, Thick Film, 0805	ERJ-6ENF3012V	Panasonic
66	1	R17	RES, 10 k Ω , 1%, 1/8 W, Thick Film, 0805	ERJ-6ENF1002V	Panasonic
67	1	R18	RES, 143 k Ω , 1%, 1/8 W, Thick Film, 0805	ERJ-6ENF1433V	Panasonic
68	1	R19	RES, 10 k Ω , 1%, 1/8 W, Thick Film, 0805	ERJ-6ENF1002V	Panasonic
69	1	R20	RES, 143 k Ω , 1%, 1/8 W, Thick Film, 0805	ERJ-6ENF1433V	Panasonic
70	1	R21	RES, 120 k Ω , 5%, 1/4 W, Thick Film, 1206	ERJ-8GEYJ124V	Panasonic
71	1	R22	RES, 243 k Ω , 1%, 1/8 W, Thick Film, 0805	ERJ-6ENF2433V	Panasonic
72	1	R23	RES, 20.0 k Ω , 1%, 1/4 W, Thick Film, 1206	ERJ-8ENF2002V	Panasonic
73	1	R24	0.04 Ω , \pm 1%, \pm 1200ppm/ $^{\circ}$ C, -55 $^{\circ}$ C ~ 155 $^{\circ}$ C, 0.25 W, 1/4W, 1206 (3216 Metric), Automotive AEC-Q200, Current Sense, Moisture Resistant, Thick Film	RL1206FR-070R04L	Yageo
74	1	R27	RES, 10 k Ω , 5%, 1/8 W, Thick Film, 0805	ERJ-6GEYJ103V	Panasonic
75	1	R29	RES, 10 k Ω , 5%, 1/8 W, Thick Film, 0805	ERJ-6GEYJ103V	Panasonic
76	1	R30	RES, 47 Ω , 5%, 1/4 W, Thick Film, 1206	ERJ-8GEYJ470V	Panasonic
77	1	R31	RES, 27 m Ω , \pm 1%, 1/4W, Chip Resistor, 1206, Automotive AEC-Q200, Current Sense, Moisture Resistant, Thick Film	RL1206FR-070R027L	Yageo
78	1	R32	RES, 10 k Ω , 5%, 1/8 W, Thick Film, 0805	ERJ-6GEYJ103V	Panasonic
79	1	R34	RES, 261 k Ω , 1%, 1/8 W, Thick Film, 0805	ERJ-6ENF2553V	Panasonic
80	1	R37	RES, 1.00 k Ω , 1%, 1/8 W, Thick Film, 0805	ERJ-6ENF1001V	Panasonic
81	1	R38	RES, 1.00 k Ω , 1%, 1/8 W, Thick Film, 0805	ERJ-6ENF1001V	Panasonic
82	1	R39	RES, 1.00 k Ω , 1%, 1/8 W, Thick Film, 0805	ERJ-6ENF1001V	Panasonic
83	1	R41	RES, 1.00 k Ω , 1%, 1/8 W, Thick Film, 0805	ERJ-6ENF1001V	Panasonic
84	1	R45	RES, 1.33 M Ω , 1%, 1/4 W, Thick Film, 1206	RC1206FR-071M33L	Yageo
85	1	R46	RES, 1.33 M Ω , 1%, 1/4 W, Thick Film, 1206	RC1206FR-071M33L	Yageo
86	1	R47	RES, 1.33 M Ω , 1%, 1/4 W, Thick Film, 1206	RC1206FR-071M33L	Yageo
87	1	R50	RES, 100 k Ω , 5%, 1/8 W, Thick Film, 0805	ERJ-6GEYJ104V	Panasonic
88	1	R53	RES, 30 k Ω , 5%, 1/8 W, Thick Film, 0805	ERJ-6GEYJ303V	Panasonic
89	1	R54	RES, 20 Ω , 5%, 1/4 W, Thick Film, 1206	ERJ-8GEYJ200V	Panasonic
90	1	R55	RES, 22 Ω , 5%, 1/8 W, Thick Film, 0805	ERJ-6GEYJ220V	Panasonic
91	1	RT1	NTC Thermistor, 2.5 Ω , 3 A	SL08 2R503	Ametherm
92	1	RV1	300 VAC, 25 J, 7 mm, RADIAL	V300LA4P	Littlefuse
93	1	T3	Bobbin, PQ26/25, Vertical, 12 pins	PQ26X25	Pin Shine
94	1	T4	Bobbin, EQ30, 10 pins, Vertical (low profile)	CSV-EQ30-1S-10P	Ferroxcube
95	1	U2	HiperPFS-4 Family, InSOP24B	PFS7626C	Power Integrations
96	1	U3	IC, REG ZENER SHUNT ADJ SOT-23	LM431BIM3/NOPB	National Semi



97	1	U4	LYTSwitch-6 Integrated Circuit, InSOP24D	LYT6079C	Power Integrations
98	1	U5	IC, DUAL Op Amp, General Purpose, 2.7 MHz, Rail to Rail, 8-SOIC (0.154", 3.90mm Width),8-SO	TSX712IDT	ST Micro
99	1	VR1	13 V, 5%, 500 MW, SOD-123	MMSZ4700T1G	ON Semi
100	1	VR2	DIODE ZENER 12 V 500 mW SOD123	MMSZ5242B-7-F	Diodes, Inc.
101	1	VR3	13 V, 5%, 500 Mw, SOD-123	MMSZ4700T1G	ON Semi

6.2 Miscellaneous Parts

Item	Qty	Ref	Description	Mfg Part Number	Mfg
1	1	SCREW1	SCREW MACHINE PHIL 6-32 X 3/8 SS	PMSSS 632 0038 PH	Building Fasteners
2	4	SCREW2	SCREW MACHINE PHIL 6-32 X 3/8 SS	PMSSS 632 0038 PH	Building Fasteners
3	1	HS1	HEAT SINK, SHTM, DER801, PI CUST, AL 3003	61-00245-00	Power Integrations
4	1	J1	CONN TERM BLOCK 5.08 mm 3POS, Screw - Leaf Spring, Wire Guard	ED120/3DS	On Shore Tech
5	1	J2	CONN TERM BLOCK, 2 POS, 5 mm, PCB	ED500/2DS	On Shore Tech
6	2	J6	CONN TERM BLOCK, 2 POS, 5 mm, PCB	ED500/2DS	On Shore Tech



7 PFC Inductor Specification (T4)

7.1 Electrical Diagram

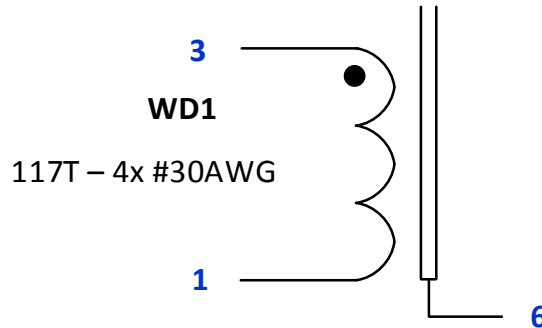

Figure 16 – PFC Inductor Electrical Diagram.

7.2 Electrical Specifications

Parameter	Condition	Spec.
Nominal Primary Inductance	Measured at 1 V _{PK-PK} , 100 kHz switching frequency, between pin 3 and pin 1.	895 μ H
Tolerance	Tolerance of Primary Inductance.	\pm 5%

7.3 Material List

Item	Description
[1]	Core: EQ30 or PC95 or Equivalent.
[2]	Bobbin: EQ30, 10 Pins.
[3]	Magnet Wire: #30 AWG.
[4]	Transformer Tape: 3M 1298 Polyester Film, 8.5 mm wide.
[5]	Transformer Tape: 3M 1298 Polyester Film, 19.5 mm wide.
[6]	Copper Strip with Adhesive: 6 mm.

7.4 PFC Inductor Build Diagram

WD1
117T – 4x #30AWG

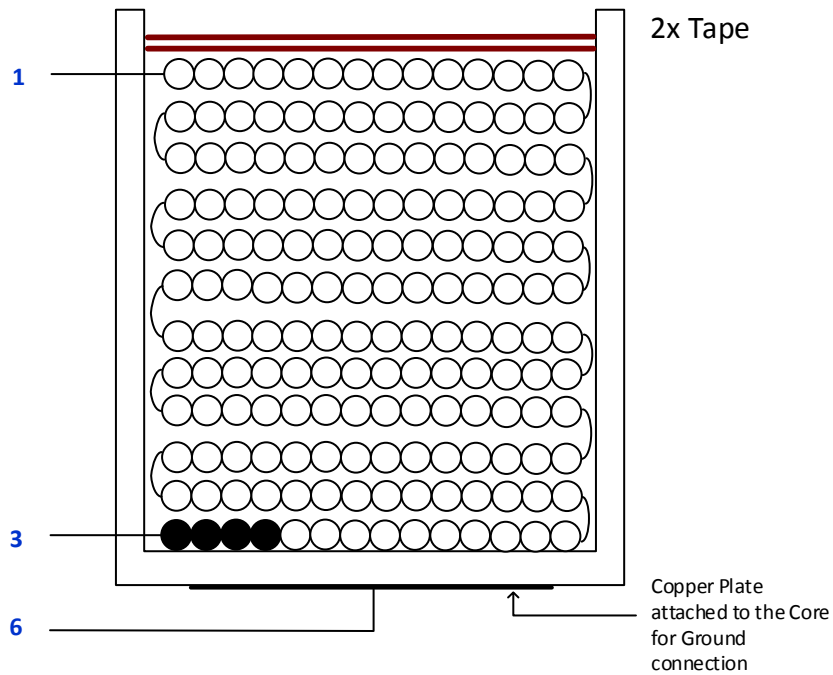

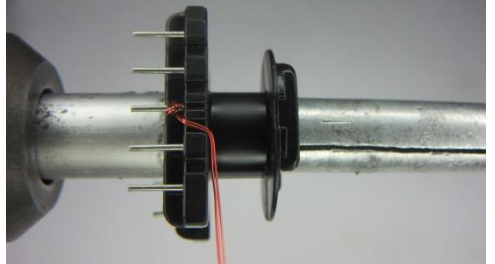
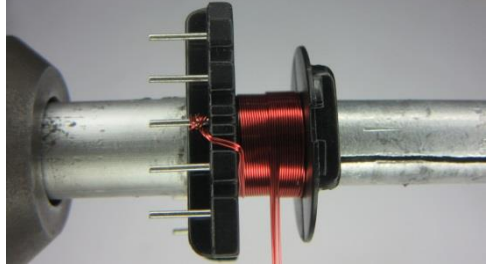
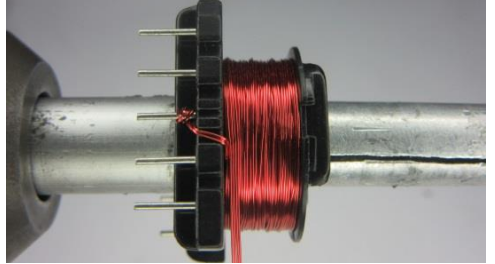
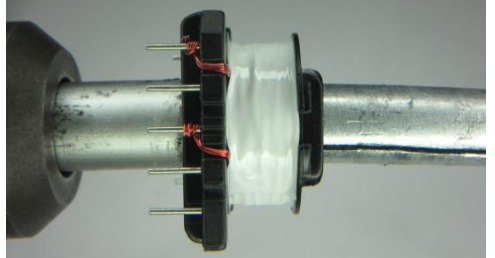

Figure 17 – PFC Inductor Build Diagram.



7.5 PFC Inductor Construction

Winding Directions	Bobbin, Item [2], is oriented on winder jig such that terminal pin 1-5 is on the left side. The winding direction is counterclockwise.
Winding	Use Item [3], start at pin 3 and wind quad-filar wire across the bobbin width.
Winding	Continue winding across the bobbin width up to 117 turns and terminate at pin 1.
Insulation	Add 2 layers of tape, Item [4], for insulation.
Core Grinding	Grind the center leg of one core, Item [1], until it meets the nominal inductance of 895 μ H.
Assemble Core	Assemble the 2 cores on the bobbin and place copper strip, Item [6] on the bottom core. Solder a wire from copper strip to pin 6.
Insulation	Wrap the core with Item [5].
Pins	Pull out terminals 2, 4, 5, 7, 8, 9, and 10.
Finish	Dip the transformer in varnish.

7.6 Winding Illustrations

<p>Winding Directions</p>	<p>Bobbin, Item [2], is oriented on winder jig such that terminal pin 1-5 is on the left side. The winding direction is counterclockwise.</p>	
<p>Winding</p>	<p>Use Item [3], start quad-filar wire at pin 3.</p>	
<p>Winding</p>	<p>Wind across the bobbin width up to 117 turns.</p>	
<p>Winding</p>	<p>Continue winding across the bobbin width. Terminate wire at pin 1.</p>	
<p>Insulation</p>	<p>Add 2 layers of tape, Item [4], for insulation.</p>	

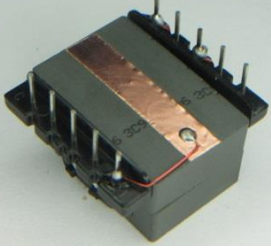

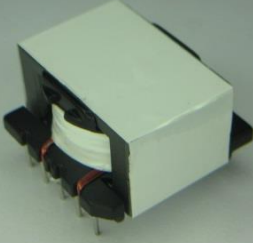
<p>Core Grinding</p>	<p>Grind the center leg of one core, Item [1], until it meets the nominal inductance of 895 μH.</p>	
<p>Assemble Core</p>	<p>Assemble the 2 cores on the bobbin and place copper strip, Item [6] on the bottom core. Solder a wire from copper strip to pin 6.</p>	
<p>Insulation</p>	<p>Wrap the core with Item [5].</p>	
<p>Pins</p>	<p>Pull out terminals 2, 4, 5, 7, 8, 9, and 10.</p>	
<p>Finish</p>	<p>Dip the transformer in varnish.</p>	

8 Transformer Specification (T3)

8.1 Electrical Diagram

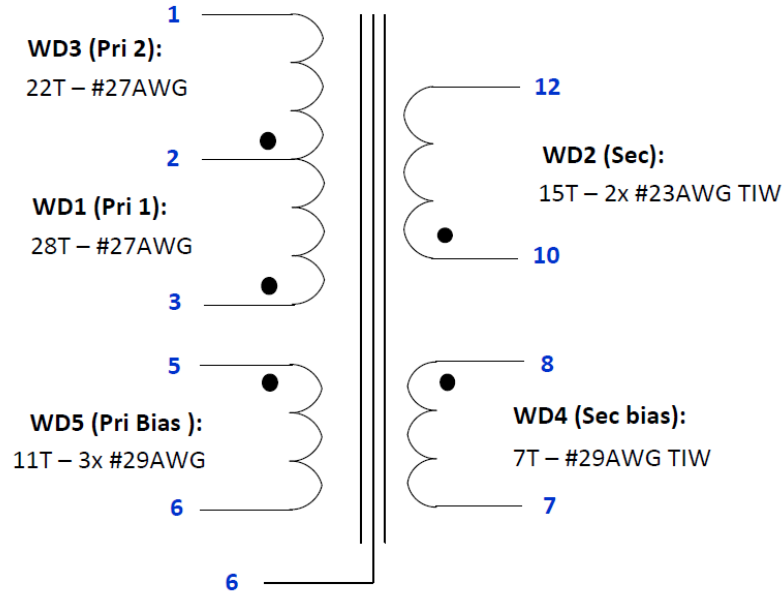

Figure 18 – Transformer Electrical Diagram.

8.2 Electrical Specifications

Parameter	Condition	Spec.
Nominal Primary Inductance	Measured at 1 V _{PK-PK} , 100 kHz switching frequency, between pin 3 and pin 1.	840 μH
Tolerance	Tolerance of Primary Inductance.	±3%
Leakage Inductance	Measured at 1 V _{PK-PK} , 100 kHz switching frequency, between pin 3 and pin 1 with all other windings shorted.	<5 μH

8.3 Material List

Item	Description
[1]	Core: PC95 or Equivalent.
[2]	Bobbin: PQ26/25, 12 Pins.
[3]	Magnet Wire: #27 AWG.
[4]	Magnet Wire: #29 AWG.
[5]	Triple-Insulated Wire: #29 AWG.
[6]	Triple-Insulated Wire: #23 AWG.
[7]	Transformer Tape: 3M 1298 Polyester Film, 13.7 mm Wide.
[8]	Transformer Tape: 3M 1298 Polyester Film, 9.6 mm Wide.
[9]	Copper Strip with Adhesive: 6 mm.

8.4 Transformer Build Diagram

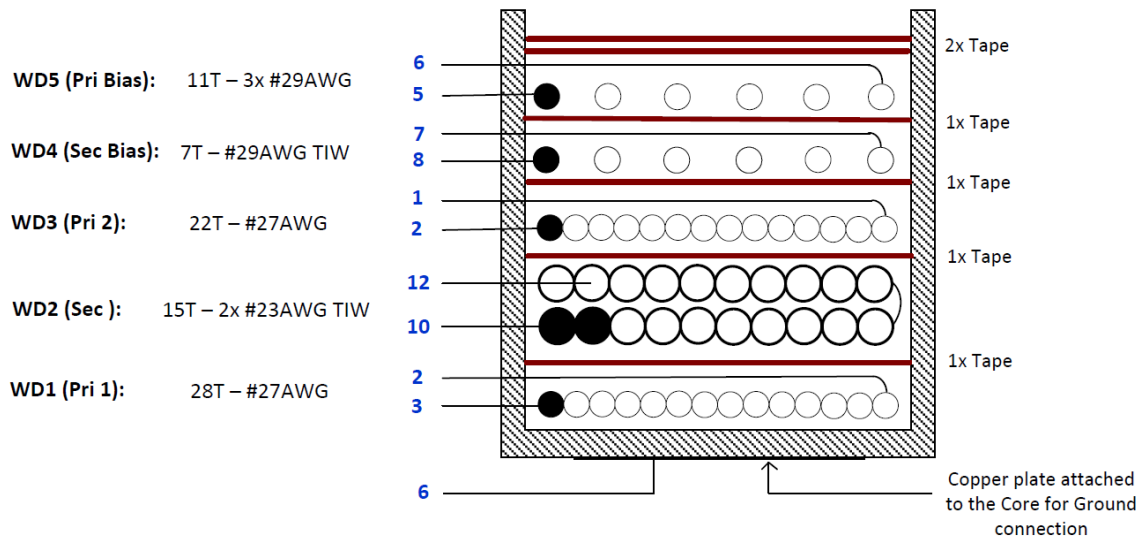
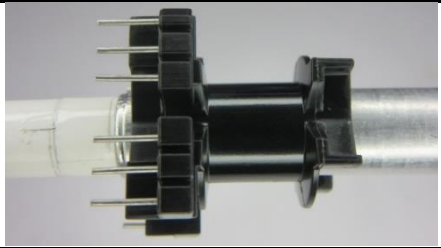
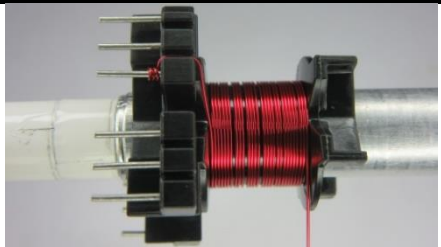
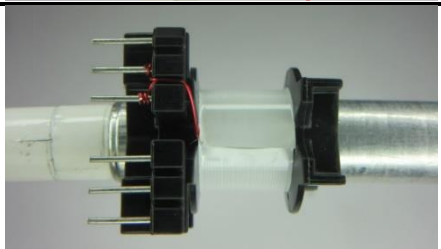
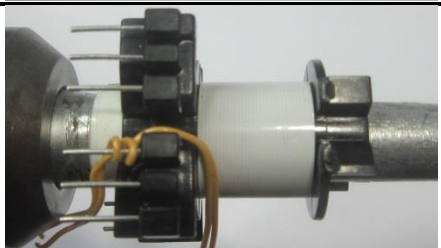
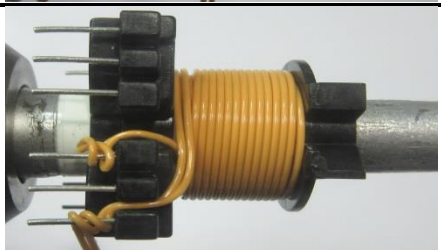



Figure 19 – Transformer Build Diagram.

8.5 Transformer Construction

Winding Directions	Bobbin, Item [2], is oriented on winder jig such that terminal pin 1-6 is on the left side. The winding direction is counterclockwise.
Winding 1	Use Item [3], start at pin 3 and wind across the bobbin width up to 28 turns. Terminate wire to pin 2.
Insulation	Add 1 layer of tape, Item [7], for insulation.
Winding 2	Use Item [6], bifilar, start at pin 10 and wind across the bobbin width up to 15 turns. Terminate wire to pin 12.
Insulation	Add 1 layer of tape, Item [7], for insulation.
Winding 3	Use Item [3], start at pin 2 and wind across the bobbin width up to 22 turns. Terminate wire to pin 1.
Insulation	Add 1 layer of tape, Item [7], for insulation.
Winding 4	Use Item [5], start at pin 8 and wind across the bobbin width up to 7 turns. Terminate wire to pin 7.
Insulation	Add 1 layer of tape, Item [7], for insulation.
Winding 5	Use Item [4], trifilar, start at pin 5 and wind across the bobbin width up to 11 turns. Terminate wire to pin 6.
Insulation	Add 2 layers of tape, Item [7], for insulation.
Core Grinding	Grind the center leg of one core, Item [1], until it meets the nominal inductance of 840 μ H.
Assemble Core	Assemble the 2 cores on the bobbin and place the copper strip, Item [9]. Solder a wire from copper strip to pin 6.
Insulation	Wrap the core with Item [8].
Pins	Pull out terminals 2, 4, 9 and 11.
Finish	Dip the transformer in varnish.

8.6 Winding Illustrations

<p>Winding Directions</p>	<p>Bobbin, Item [2], is oriented on winder jig such that terminal pin 1-6 is on the left side. The winding direction is counterclockwise.</p>	
<p>Winding 1</p>	<p>Use Item [3], start at pin 3 and wind across the bobbin width up to 28 turns. Terminate wire to pin 2.</p>	
<p>Insulation</p>	<p>Add 1 layer of tape, Item [7], for insulation.</p>	
<p>Winding 2</p>	<p>Use Item [6], bifilar, start at pin 10.</p>	
<p>Winding 2</p>	<p>Wind across the bobbin width up to 15 turns. Terminate wire to pin 12.</p>	
<p>Insulation</p>	<p>Add 1 layer of tape, Item [7], for insulation.</p>	

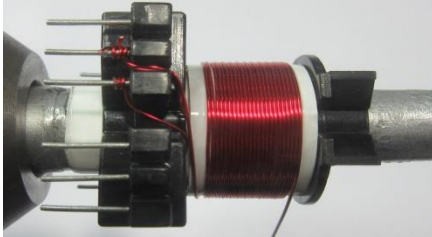
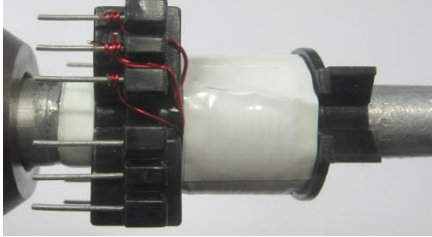
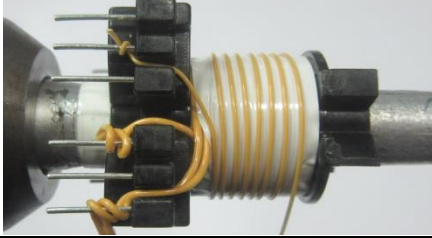
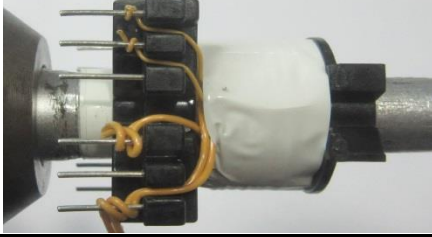
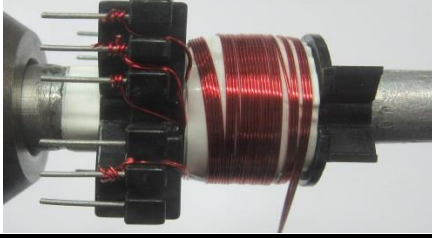
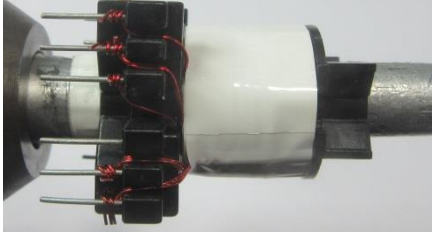
<p>Winding 3</p>	<p>Use Item [3], start at pin 2 and wind across the bobbin width up to 22 turns. Terminate wire to pin 1.</p>	
<p>Insulation</p>	<p>Add 1 layer of tape, Item [7], for insulation.</p>	
<p>Winding 4</p>	<p>Use Item [5], start at pin 8 and wind across the bobbin width up to 7 turns. Terminate wire to pin 7.</p>	
<p>Insulation</p>	<p>Add 1 layer of tape, Item [7], for insulation.</p>	
<p>Winding 5</p>	<p>Use Item [4], trifilar, start at pin 5 and wind across the bobbin width up to 11 turns. Terminate wire to pin 6.</p>	
<p>Insulation</p>	<p>Add 2 layers of tape, Item [7], for insulation.</p>	

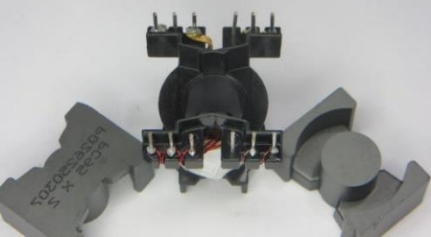
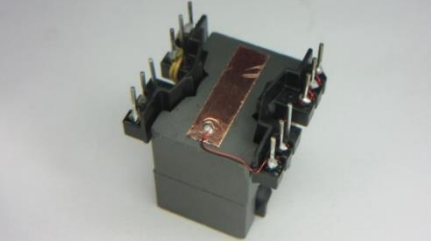
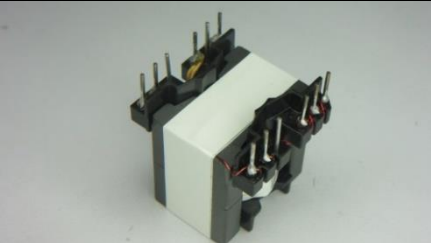
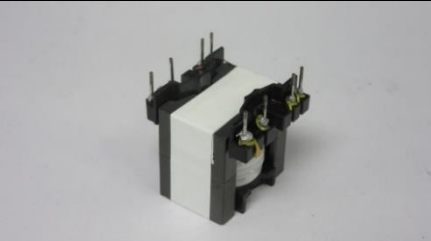
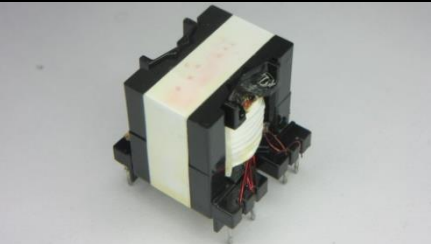
<p>Core Grinding</p>	<p>Grind the center leg of one core, Item [1], until it meets the nominal inductance of 840 μH.</p>	
<p>Assemble Core</p>	<p>Assemble the 2 cores on the bobbin and place the copper strip, Item [9]. Solder a wire from copper strip to pin 6.</p>	
<p>Insulation</p>	<p>Wrap the core with Item [8].</p>	
<p>Pins</p>	<p>Pull out terminals 2, 4, 9 and 11.</p>	
<p>Finish</p>	<p>Dip the transformer in varnish.</p>	

9 Input Common Mode Choke Specification (L1)

9.1 Electrical Diagram

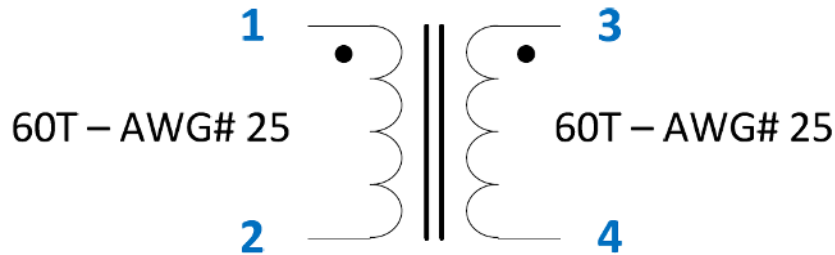

Figure 20 – Common Mode Choke Electrical Diagram.

9.2 Electrical Specifications

Parameter	Condition	Spec.
Inductance	Pins 1-2, 3-4 measured at 100 kHz.	20 mH, $\pm 20\%$

9.3 Material List

Item	Description
[1]	Core: JL15 (JLW ELECTRONICS (HONG KONG) LIMITED) AL = 9000 nH/N ² Mfg P/N: T18x10x7C-JL15*.
[2]	Divider –Illustration Board, insulating cotton rag, 0.049" thick, Cut to size 0.382"x0.283".
[3]	Magnetic Wire: 25 AWG.
[4]	Number of Turns: 60 each section.

9.4 Winding Instructions

1. Insert the divider (see details below) in the core to divide into 2 sections equally.

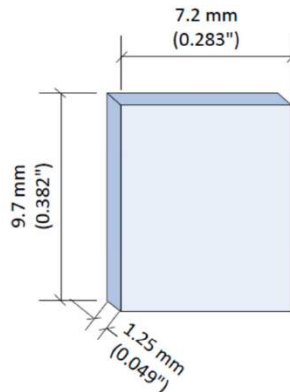

Figure 21 – Common Mode Choke Divider Specifications (Material: Illustration board).

2. Start winding on one section with 25 turns or completely fill up the section for the 1st and 2nd layer, then equally spread the remaining turns for the 3rd layer.
3. Repeat step 2 for the other section winding. Make sure it starts from the SAME side and winding direction as step 2. See picture below.

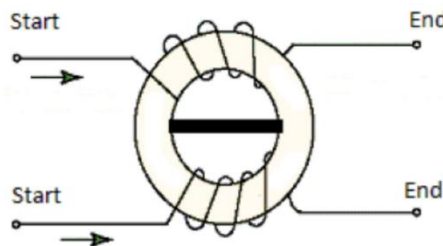

Figure 22 – Common Mode Choke Winding Direction.

4. Cut and drill a PCB bare board with specifications seen below. This will provide as base for the common mode choke.

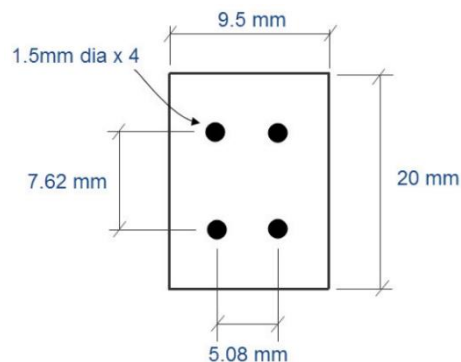

Figure 23 – Common Mode Choke Base specification.

10 Output Common Mode Choke Specification (L3)

10.1 Electrical Diagram

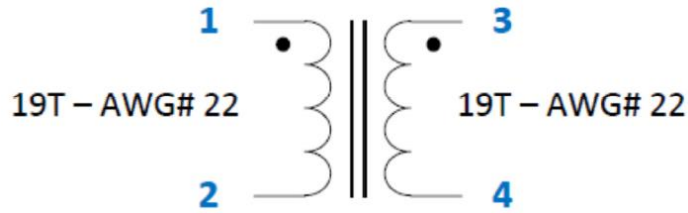

Figure 24 – Common Mode Choke Electrical Diagram.

10.2 Electrical Specifications

Parameter	Condition	Spec.
Inductance	Pins 1-2, 3-4 measured at 10 kHz.	1.8 mH, $\pm 20\%$

10.3 Material List

Item	Description
[1]	Core: JL10 (JLW ELECTRONICS (HONG KONG) LIMITED). AL = 9000 nH/N ² . Mfg P/N: T14x8x5.5C-JL10*.
[2]	Polyester tape, 1mil thickness, 3mm wide.
[3]	Magnetic Wire: 22 AWG.
[4]	Number of Turns: 19 each section.

10.4 Winding Instructions

1. Wind 5 layers of polyester tape Item [2] (see illustration below) in the two sides of the core to divide it into 2 sections equally.

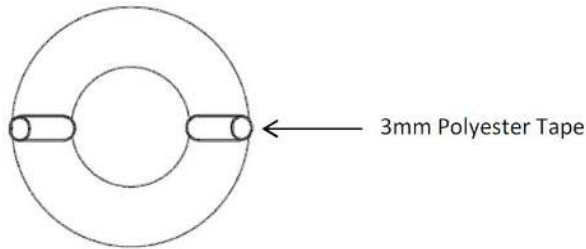

Figure 25 – Common Mode Choke Divider Specifications.

2. Start winding on one section with 14 turns or completely fill up the section for the 1st, then equally spread the remaining turns for the 2nd layer.
3. Repeat step 2 for the other section winding. Make sure it starts from the SAME side and winding direction as step 2. See picture below.

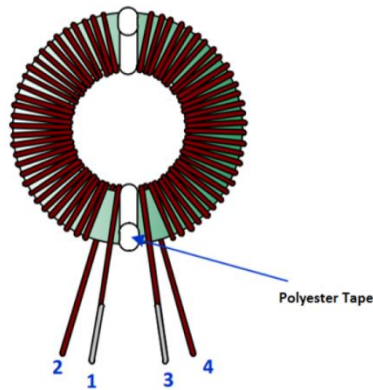

Figure 26 – Common Mode Choke Winding direction.

4. Create a base support using a PCB bare board, with specifications below.

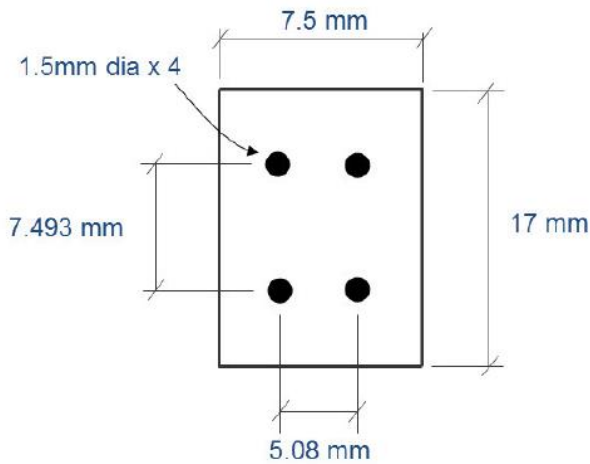

Figure 27 – Common Mode Choke Base specification.



11 Design Spreadsheet

11.1 HiperPFS-4 Design Spreadsheet

Hiper_PFS-4_Boost_062918; Rev.1.1; Copyright Power Integrations 2018	INPUT	INFO	OUTPUT	UNITS	Continuous Mode Boost Converter Design Spreadsheet
Enter Application Variables					
Input Voltage Range	Universal		Universal		Input voltage range
VACMIN	100		100	VAC	Minimum AC input voltage. Spreadsheet simulation is performed at this voltage. To examine operation at other voltages, enter here, but enter fixed value for LPFC_ACTUAL.
VACMAX	277		277	VAC	Maximum AC input voltage
VBROWNIN		Info	84	VAC	Brown-IN voltage has been modified since the V-pin ratio is no longer 100:1
VBROWNOUT		Info	73	VAC	Brown-OUT voltage has been modified since the V-pin ratio is no longer 100:1
VO	410	Info	410	VDC	Brown IN/OUT voltage has changed due to modifications in the V-pin ratio from 100:1. Recommend Vpin ratio= FB pin ratio for optimized operation. Check the PF, input current distortion, brown in/out and power delivery
PO	110	Warning	110	W	Device rated power exceeded. Select larger device
fL			50	Hz	Line frequency
TA Max			40	°C	Maximum ambient temperature
n			0.93		Efficiency should be between 0.85 and 0.99. Also, refer to the Loss Budget section and ensure that the estimated efficiency is close to the simulated efficiency
VO_MIN			390	VDC	Minimum Output voltage
VO_RIPPLE_MAX	15		15	VDC	Maximum Output voltage ripple
tHOLDUP			20	ms	Holdup time
VHOLDUP_MIN			310	VDC	Minimum Voltage Output can drop to during holdup
I_INRUSH			40	A	Maximum allowable inrush current
Forced Air Cooling	No		No		Enter "Yes" for Forced air cooling. Otherwise enter "No". Forced air reduces acceptable choke current density and core autpick core size
KP and INDUCTANCE					
KP_TARGET	0.73		0.73		Target ripple to peak inductor current ratio at the peak of VACMIN. Affects inductance value
LPFC_TARGET (0 bias)			899	uH	PFC inductance required to hit KP_TARGET at peak of VACMIN and full load
LPFC_DESIRED (0 bias)			899	uH	LPFC value used for calculations. Leave blank to use LPFC_TARGET. Enter value to hold constant (also enter core selection) while changing VACMIN to examine brownout operation. Calculated inductance with rounded (integral) turns for powder core.
KP_ACTUAL			0.683		Actual KP calculated from LPFC_ACTUAL
LPFC_PEAK			899	uH	Inductance at VACMIN, 90°. For Ferrite, same as LPFC_DESIRED (0 bias)
Basic current parameters					
IAC_RMS			1.18	A	AC input RMS current at VACMIN and Full Power load
IO_DC			0.27	A	Output average current/Average diode



					current
PFS Parameters					
PFS Package	C		C		HiperPFS package selection
PFS Part Number	PFS7626C	Info	PFS7626C		Peak power rating for the device has been exceeded. Output will droop. Select larger device
Operating Mode	Full Power		Full Power		Mode of operation of PFS. For Full Power mode enter "Full Power" otherwise enter "EFFICIENCY" to indicate efficiency mode
IOCP min			6.8	A	Minimum Current limit
IOCP typ			7.2	A	Typical current limit
IOCP max			7.5	A	Maximum current limit
IP			2.44	A	MOSFET peak current
IRMS			1.02	A	PFS MOSFET RMS current
RDSON			0.48	Ohms	Typical RDson at 100 °C
FS_PK			54	kHz	Estimated frequency of operation at crest of input voltage (at VACMIN)
FS_AVG			41	kHz	Estimated average frequency of operation over line cycle (at VACMIN)
PCOND_LOSS_PFS			0.5	W	Estimated PFS conduction losses
PSW_LOSS_PFS			0.6	W	Estimated PFS switching losses
PFS_TOTAL			1.1	W	Total Estimated PFS losses
TJ Max			100	deg C	Maximum steady-state junction temperature
Rth-JS			2.80	°C/W	Maximum thermal resistance (Junction to heatsink)
HEATSINK Theta-CA			53.47	°C/W	Maximum thermal resistance of heatsink
INDUCTOR DESIGN					
Basic Inductor Parameters					
LPFC (0 Bias)			899	uH	Value of PFC inductor at zero current. This is the value measured with LCR meter. For powder, it will be different than LPFC.
LP_TOL			10.0	%	Tolerance of PFC Inductor Value (ferrite only)
IL_RMS			1.20	A	Inductor RMS current (calculated at VACMIN and Full Power Load)
Material and Dimensions					
Core Type	Ferrite		Ferrite		Enter "Sendust", "Iron Powder" or "Ferrite"
Core Material	Auto		PC44/PC95		Select from 60u, 75u, 90u or 125 u for Sendust cores. Fixed at PC44/PC95 for Ferrite cores. Fixed at -52 material for Pow Iron cores.
Core Geometry	EQ		EQ		Toroid only for Sendust and Powdered Iron; EE or PQ for Ferrite cores.
Core	Auto		EQ30		Core part number
Ae			108.00	mm ²	Core cross sectional area
Le			46.00	mm	Core mean path length
AL			3900.00	nH/t ²	Core AL value
Ve			4.97	cm ³	Core volume
HT (EE/PQ/EQ/RM/POT) / ID (toroid)			6.35	mm	Core height/Height of window; ID if toroid
MLT			60.4	mm	Mean length per turn
BW			8.40	mm	Bobbin width
LG			1.69	mm	Gap length (Ferrite cores only)
Flux and MMF calculations					
BP_TARGET (ferrite only)	5900	Info	5900	Gauss	Info: Peak flux density is too high. Check for Inductor saturation during line transient operation
B_OCP (or BP)		Warning	5869	Gauss	Warning: Peak flux density is too high. Check for Inductor saturation during load steps
B_MAX			1874	Gauss	peak flux density at AC peak, VACMIN and Full Power Load, nominal inductance
μ_TARGET (powder)			N/A	%	target μ at peak current divided by μ at zero

only)					current, at VACMIN, full load (powder only) - drives auto core selection
μ _MAX (powder only)			N/A	%	μ _max greater than 75% indicates a very large core. Please verify
μ _OCP (powder only)			N/A	%	μ at IOCPtyp divided by μ at zero current
I_TEST	5.0		5.0	A	Current at which B_TEST and H_TEST are calculated, for checking flux at a current other than IOCP or IP; if blank IOCP_typ is used.
B_TEST			3913	Gauss	Flux density at I_TEST and maximum tolerance inductance
μ _TEST (powder only)			N/A	%	μ at IOCP divided by μ at zero current, at IOCPtyp
Wire					
TURNS			117		Inductor turns. To adjust turns, change BP_TARGET (ferrite) or μ _TARGET (powder)
ILRMS			1.20	A	Inductor RMS current
Wire type	Magnet		Magnet		Select between "Litz" or "Magnet" for double coated magnet wire
AWG	30	Info	30	AWG	!!! Info. Selected wire gauge is too thick and may caused increased losses due to skin effect. Consider using multiple strands of thinner wires or Litz wire
Filar	4		4		Inductor wire number of parallel strands. Leave blank to auto-calc for Litz
OD (per strand)			0.254	mm	Outer diameter of single strand of wire
OD bundle (Litz only)			N/A	mm	Will be different than OD if Litz
DCR			0.80	ohm	Choke DC Resistance
P AC Resistance Ratio		Info	3.33		AC resistance is high. Check copper loss, use Litz or thinner wire and fewer layers, or reduce Kp
J			5.91	A/mm ²	Estimated current density of wires. It is recommended that $4 < J < 6$
FIT			57%	%	Percentage fill of winding window for EE/PQ core. Full window approx. 90%
Layers			15.6		Estimated layers in winding
Loss calculations					
BAC-p-p			1368	Gauss	Core AC peak-peak flux excursion at VACMIN, peak of sine wave
LPFC_CORE_LOSS			0.12	W	Estimated Inductor core Loss
LPFC_COPPER_LOSS		Info	3.83	W	Info: Copper loss too high. Adjust wire gauge and/or filar, being mindful of AC Resistance ratio
LPFC_TOTAL_LOSS			3.95	W	Total estimated Inductor Losses
External PFC Diode					
PFC Diode Part Number	LQA03TC600		LQA03TC600		PFC Diode Part Number
Type			Qspeed		PFC Diode Type
Manufacturer			PI		Diode Manufacturer
VRRM			600.00	V	Diode rated reverse voltage
IF			3.00	A	Diode rated forward current
Qrr			17.50	nC	High Temperature
VF			2.30	V	Diode rated forward voltage drop
PCOND_DIODE			0.62	W	Estimated Diode conduction losses
PSW_DIODE			0.03	W	Estimated Diode switching losses
P_DIODE			0.64	W	Total estimated Diode losses
TJ Max			100	deg C	Maximum steady-state operating temperature
Rth-JS			3.85	degC/W	Maximum thermal resistance (Junction to heatsink)
HEATSINK Theta-CA			88.71	degC/W	Maximum thermal resistance of heatsink
IFSM			30.00	A	Non-repetitive peak surge current rating. Consider larger size diode if inrush or thermal limited.
Output Capacitor					



CO _{UT}	Auto		68	uF	Minimum value of Output capacitance
VO_RIPPLE_EXPECTED			13.5	V	Expected ripple voltage on Output with selected Output capacitor
T_HOLDUP_EXPECTED			22.3	ms	Expected holdup time with selected Output capacitor
ESR_LF			2.93	ohms	Low Frequency Capacitor ESR
ESR_HF		Warning	1.17	ohms	!!! Warning high frequency ESR must be between 0.01 and 1 ohms
IC_RMS_LF			0.18	A	Low Frequency Capacitor RMS current
IC_RMS_HF			0.47	A	High Frequency Capacitor RMS current
CO_LF_LOSS			0.09	W	Estimated Low Frequency ESR loss in Output capacitor
CO_HF_LOSS			0.26	W	Estimated High frequency ESR loss in Output capacitor
Total CO LOSS			0.35	W	Total estimated losses in Output Capacitor
Input Bridge (BR1) and Fuse (F1)					
I ^{^2} t Rating			5.22	A ² *s	Minimum I ^{^2} t rating for fuse
Fuse Current rating			1.93	A	Minimum Current rating of fuse
VF			0.90	V	Input bridge Diode forward Diode drop
I _{AVG}			1.20	A	Input average current at 70 VAC.
PIV_INPUT BRIDGE			392	V	Peak inverse voltage of input bridge
PCOND_LOSS_BRIDGE			1.92	W	Estimated Bridge Diode conduction loss
CIN			0.3	uF	Input capacitor. Use metallized polypropylene or film foil type with high ripple current rating
RT1			9.79	ohms	Input Thermistor value
D_Precharge			1N5407		Recommended precharge Diode
PFS4 small signal components					
C_REF			1.0	uF	REF pin capacitor value
RV1			4.0	MOhms	Line sense resistor 1
RV2			6.0	MOhms	Line sense resistor 2
RV3			6.0	MOhms	Typical value of the lower resistor connected to the V-PIN. Use 1% resistor only!
RV4			151.7	kOhms	Description pending, could be modified based on feedback chain R1-R4
C_V			0.527	nF	V pin decoupling capacitor (RV4 and C_V should have a time constant of 80us) Pick the closest available capacitance.
C_VCC			1.0	uF	Supply decoupling capacitor
C_C			100	nF	Feedback C pin decoupling capacitor
Power good Vo lower threshold VPG(L)			333	V	Vo lower threshold voltage at which power good signal will trigger
PGT set resistor			312.7	kohm	Power good threshold setting resistor
Feedback Components					
R1			4.0	Mohms	Feedback network, first high voltage divider resistor
R2			6.0	Mohms	Feedback network, second high voltage divider resistor
R3			6.0	Mohms	Feedback network, third high voltage divider resistor
R4			151.7	kohms	Feedback network, lower divider resistor
C1			0.527	nF	Feedback network, loop speedup capacitor. (R4 and C1 should have a time constant of 80us) Pick the closest available capacitance.
R5			27.4	kohms	Feedback network: zero setting resistor
C2			1000	nF	Feedback component- noise suppression capacitor
Loss Budget (Estimated at VACMIN)					
PFS Losses			1.07	W	Total estimated losses in PFS
Boost diode Losses			0.64	W	Total estimated losses in Output Diode
Input Bridge losses			1.92	W	Total estimated losses in input bridge module
Inductor losses			3.95	W	Total estimated losses in PFC choke
Output Capacitor Loss			0.35	W	Total estimated losses in Output capacitor
EMI choke copper loss			0.50	W	Total estimated losses in EMI choke copper

Total losses			7.93	W	Overall loss estimate
Efficiency			0.93		Estimated efficiency at VACMIN, full load.
CAPZero component selection recommendation					
CAPZero Device			CAP200DG		(Optional) Recommended CAPZero device to discharge X-Capacitor with time constant of 1 second
Total Series Resistance (Rcapzero1+Rcapzero2)			0.78	M-ohms	Maximum Total Series resistor value to discharge X-Capacitors
EMI filter components recommendation					
CIN_RECOMMENDED			470	nF	Metallized polyester film capacitor after bridge, ratio with Po
CX2			470	nF	X capacitor after differential mode choke and before bridge, ratio with Po
LDM_calc			270	uH	estimated minimum differential inductance to avoid <10kHz resonance in input current
CX1			470	nF	X capacitor before common mode choke, ratio with Po
LCM			10	mH	typical common mode choke value
LCM_leakage			30	uH	estimated leakage inductance of CM choke, typical from 30~60uH
CY1 (and CY2)			220	pF	typical Y capacitance for common mode noise suppression
LDM_Actual			240	uH	cal_LDM minus LCM_leakage, utilizing CM leakage inductance as DM choke.
DCR_LCM			0.10	Ohms	total DCR of CM choke for estimating copper loss
DCR_LDM			0.10	Ohms	total DCR of DM choke(or CM #2) for estimating copper loss
Note: CX2 can be placed between CM chock and DM choke depending on EMI design requirement.					

Note: All warnings were verified on actual bench tests and passed the criteria specified on the spreadsheet.

11.2 LYTSwitch-6 Design Spreadsheet

DCDC_LYTSwitch6_Flyback_040419; Rev.1.0; Copyright Power Integrations 2019	INPUT	INFO	OUTPUT	UNITS	DCDC LYTSwitch6 Flyback Design Spreadsheet
APPLICATION VARIABLES					
VDCIN_MIN	400		400	V	Minimum input DC voltage
VDCIN_MAX	420		420	V	Maximum input DC voltage
VOUT	48.00		48.00	V	Output voltage
IOUT	2.100		2.100	A	Output current
POUT			100.80	W	Output power
EFFICIENCY			0.93		DC-DC efficiency estimate at full load
FACTOR_Z			0.50		Z-factor estimate
ENCLOSURE	OPEN FRAME		OPEN FRAME		Power supply enclosure
PRIMARY CONTROLLER SELECTION					
ILIMIT_MODE	INCREASED		INCREASED		Device current limit mode
VDRAIN_BREAKDOWN	750		750	V	Device breakdown voltage
DEVICE_GENERIC	LYT60X9		LYT60X9		Generic device code
DEVICE_CODE			LYT6079C		Actual device code
POUT_MAX			100	W	Power capability of the device based on thermal performance
RDSON_100DEG			0.62	Ω	Primary switch on time drain resistance at 100 degC
ILIMIT_MIN			1.980	A	Minimum current limit of the primary switch
ILIMIT_TYP			2.130	A	Typical current limit of the primary switch
ILIMIT_MAX			2.279	A	Maximum current limit of the primary switch
VDRAIN_ON_PRSW			0.16	V	Primary switch on time drain voltage
VDRAIN_OFF_PRSW			650.0	V	Peak drain voltage on the primary switch during turn-off
WORST CASE ELECTRICAL PARAMETERS					
FSWITCHING_MAX	71000		71000	Hz	Maximum switching frequency at full load and minimum DC input voltage
VOR	160.0		160.0	V	Secondary voltage reflected to the primary when the primary switch turns off
KP			1.05		Measure of continuous/discontinuous mode of operation
MODE_OPERATION			DCM		Mode of operation
DUTYCYCLE			0.277		Primary switch duty cycle
TIME_ON			4.54	us	Primary switch on-time
TIME_OFF			10.21	us	Primary switch off-time
LPRIMARY_MIN			813.3	uH	Minimum primary inductance
LPRIMARY_TYP			838.5	uH	Typical primary inductance
LPRIMARY_TOL	3.0		3.0	%	Primary inductance tolerance
LPRIMARY_MAX			863.6	uH	Maximum primary inductance
PRIMARY CURRENTS					
IPEAK_PRIMARY			2.118	A	Primary switch peak current
IPEDESTAL_PRIMARY			0.000	A	Primary switch current pedestal
Iavg_PRIMARY			0.262	A	Primary switch average current
IRIPPLE_PRIMARY			2.118	A	Primary switch ripple current
IRMS_PRIMARY			0.608	A	Primary switch RMS current
SECONDARY CURRENTS					
IPEAK_SECONDARY			7.059	A	Secondary winding peak current
IPEDESTAL_SECONDARY			0.000	A	Secondary winding current pedestal
IRMS_SECONDARY			3.202	A	Secondary winding RMS current
IRIPPLE_CAP_OUT					
TRANSFORMER CONSTRUCTION PARAMETERS					
CORE SELECTION					

CORE	PQ26/25	Info	PQ26/25		The transformer windings may not fit: pick a bigger core or bobbin and refer to the Transformer Parameters tab for fit calculations
CORE CODE			B65877A0000R095		Core code
AE			122.00	mm ²	Core cross sectional area
LE			53.60	mm	Core magnetic path length
AL			5700	nH/turns ²	Ungapped core effective inductance
VE			6530.0	mm ³	Core volume
BOBBIN			B65878E1012D001		Bobbin
AW			47.00	mm ²	Window area of the bobbin
BW			12.70	mm	Bobbin width
MARGIN			0.0	mm	Safety margin width (Half the primary to secondary creepage distance)
PRIMARY WINDING					
NPRIMARY			50		Primary turns
BPEAK			3303	Gauss	Peak flux density
BMAX			2974	Gauss	Maximum flux density
BAC			1487	Gauss	AC flux density (0.5 x Peak to Peak)
ALG			335	nH/turns ²	Typical gapped core effective inductance
LG			0.430	mm	Core gap length
LAYERS_PRIMARY			2		Number of primary layers
AWG_PRIMARY	27		27	AWG	Primary winding wire AWG
OD_PRIMARY_INSULATED			0.418	mm	Primary winding wire outer diameter with insulation
OD_PRIMARY_BARE			0.361	mm	Primary winding wire outer diameter without insulation
CMA_PRIMARY			332	Cmil/A	Primary winding wire CMA
PRIMARY BIAS WINDING					
NBIAS_PRIMARY			13		Primary bias turns
SECONDARY WINDING					
NSECONDARY	15		15		Secondary turns
AWG_SECONDARY	21		21	AWG	Secondary winding wire AWG
OD_SECONDARY_INSULATE D			1.029	mm	Secondary winding wire outer diameter with insulation
OD_SECONDARY_BARE			0.723	mm	Secondary winding wire outer diameter without insulation
CMA_SECONDARY			253	Cmil/A	Secondary winding wire CMA
SECONDARY BIAS WINDING					
NBIAS_SECONDARY			7		Secondary bias turns (Required only for VOUT>24V or VOUT<4.4V)
PRIMARY COMPONENTS SELECTION					
LINE UNDERVOLTAGE					
OV REQUIRED			428.4	V	Required DC over-voltage threshold
OV ACTUAL			430.2	V	Actual DC over-voltage threshold
RLS			3.64	MΩ	Connect two 1.82 MOhm resistors to the V-pin for the required UV/OV threshold
BROWN-IN ACTUAL			96.6	V	Actual DC brown-in threshold
BROWN-OUT ACTUAL			93.4	V	Actual DC brown-out threshold
PRIMARY BIAS WINDING DIODE					
VBIAS_PRIMARY	38.0		38.0	V	Rectified bias voltage
VF_BIAS_PRIMARY			0.70	V	Secondary bias winding diode forward drop
VREVERSE_PRIBIASDIODE_PRIMARY			147.20	V	Primary bias diode reverse voltage (not accounting parasitic voltage ring)
CBIAS_PRIMARY			22	uF	Primary bias winding rectification capacitor
CBPP			4.70	uF	BPP pin capacitor
SECONDARY COMPONENTS					
FEEDBACK					



RFB_UPPER	590.00		590.00	kΩ	Upper feedback resistor (connected to the first output voltage)
RFB_LOWER			15.80	kΩ	Lower feedback resistor
CFB_LOWER			330	pF	Lower feedback resistor decoupling capacitor
RECTIFIER					
VREVERSE_RECTIFIER			174.0		Secondary rectifier reverse voltage (not accounting parasitic voltage ring)
TYPE_RECTIFIER	AUTO		DIODE		Type of secondary rectifier used
RECTIFIER	AUTO		STTH3R04		Secondary rectifier
VF_RECTIFIER			1.500		Secondary rectifier forward voltage drop
BVDSS_RECTIFIER			400		Breakdown voltage of the secondary rectifier
RDSON_RECTIFIER			NA		On-time drain to source resistance of the secondary rectifier
TRR_RECTIFIER			18.0		Reverse recovery time of the ultra-fast diode
SECONDARY BIAS WINDING DIODE					
VBIAS_SECONDARY	20		20	V	Rectified secondary bias voltage
VF_BIAS_SECONDARY			0.7	V	Secondary bias winding diode forward drop
VREVERSE_BIASDIODE_SECONDARY			78.80	V	Secondary bias diode reverse voltage (not accounting parasitic voltage ring)
CBIAS_SECONDARY			22	uF	Secondary bias winding rectification capacitor
TOLERANCE ANALYSIS					
USER_VDC			410	V	Input DC voltage corner to be evaluated
USER_ILIMIT	TYP		2.130	A	Current limit corner to be evaluated
USER_LPRIMARY	TYP		838.5	uH	Primary inductance corner to be evaluated
MODE_OPERATION			DCM		Mode of operation
KP			1.144		Measure of continuous/discontinuous mode of operation
FSWITCHING			62007	Hz	Switching frequency at full load and valley of the rectified minimum AC input voltage
DUTYCYCLE			0.254		Steady state duty cycle
TIME_ON			4.10	us	Primary switch on-time
TIME_OFF			12.02	us	Primary switch off-time
IPEAK_PRIMARY			2.006	A	Primary switch peak current
IPEDESTAL_PRIMARY			0.000	A	Primary switch current pedestal
IAVERAGE_PRIMARY			0.255	A	Primary switch average current
IRIPPLE_PRIMARY			2.006	A	Primary switch ripple current
IRMS_PRIMARY			0.584	A	Primary switch RMS current
BPEAK			2997	Gauss	Peak flux density
BMAX			2757	Gauss	Maximum flux density
BAC			1379	Gauss	AC flux density (0.5 x Peak to Peak)

12 Heat Sink Assembly

12.1 Heat Sink Fabrication Drawing

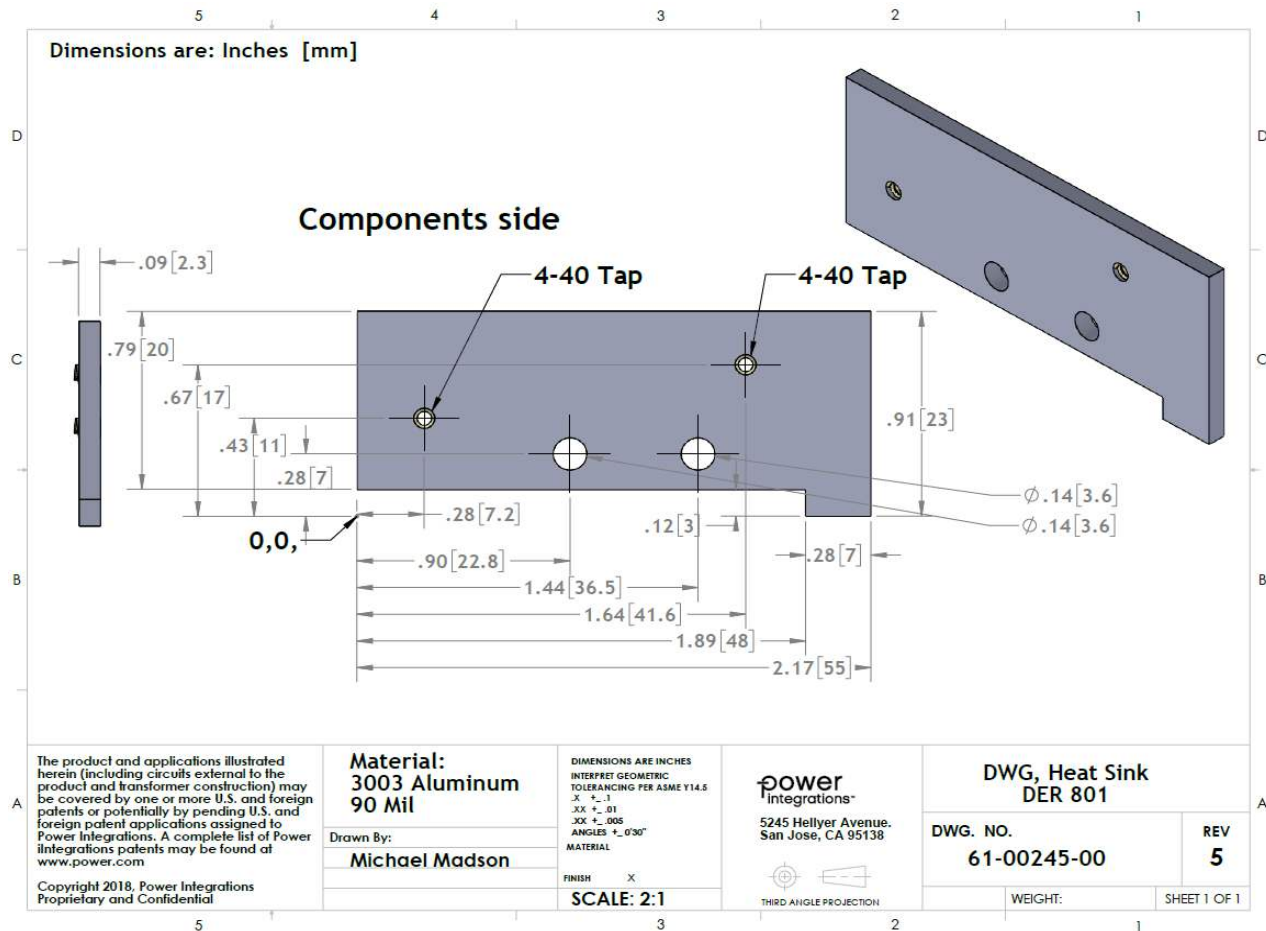

12.2 Heat Sink Fabrication Drawing

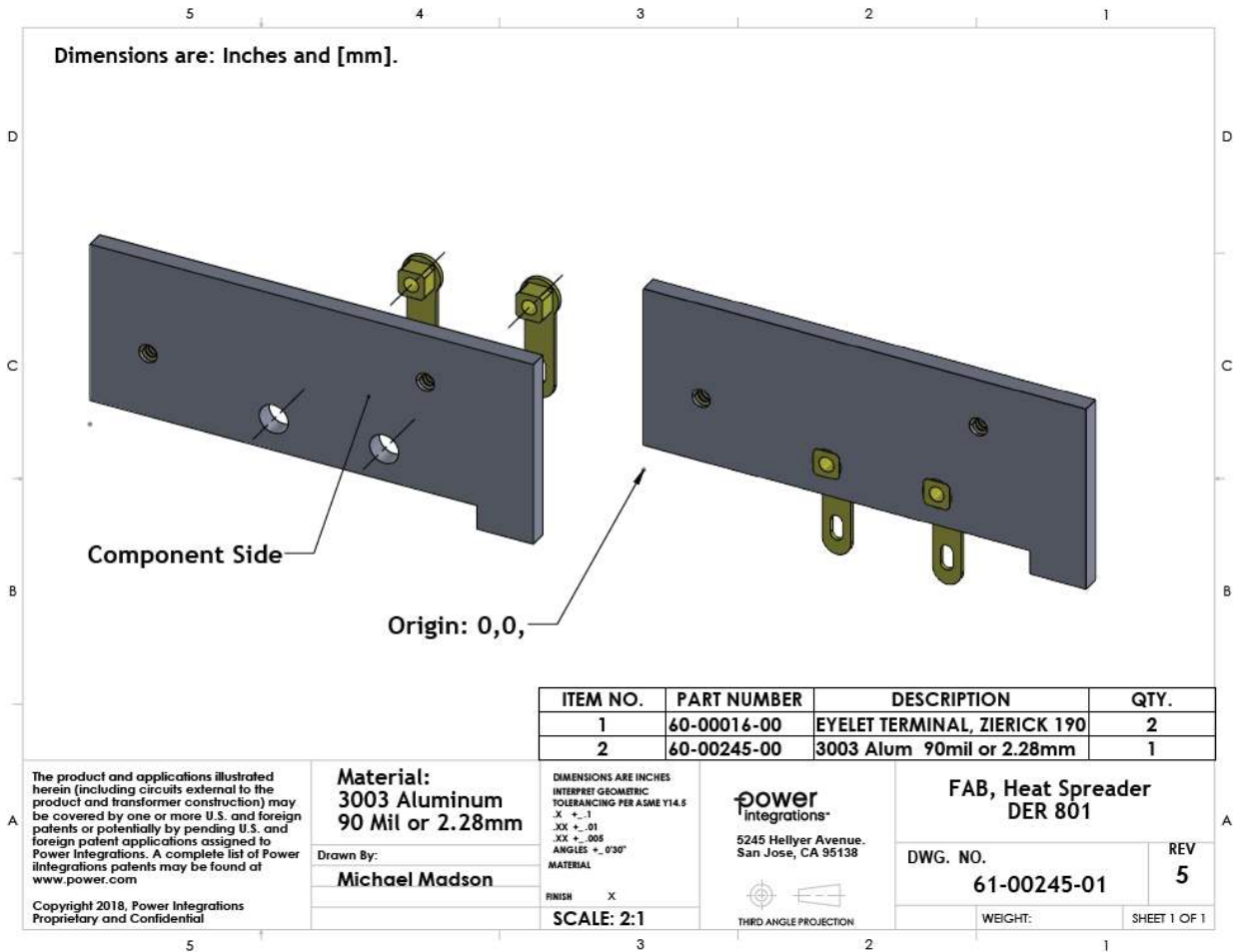

12.3 Heat Sink and Assembly Drawing

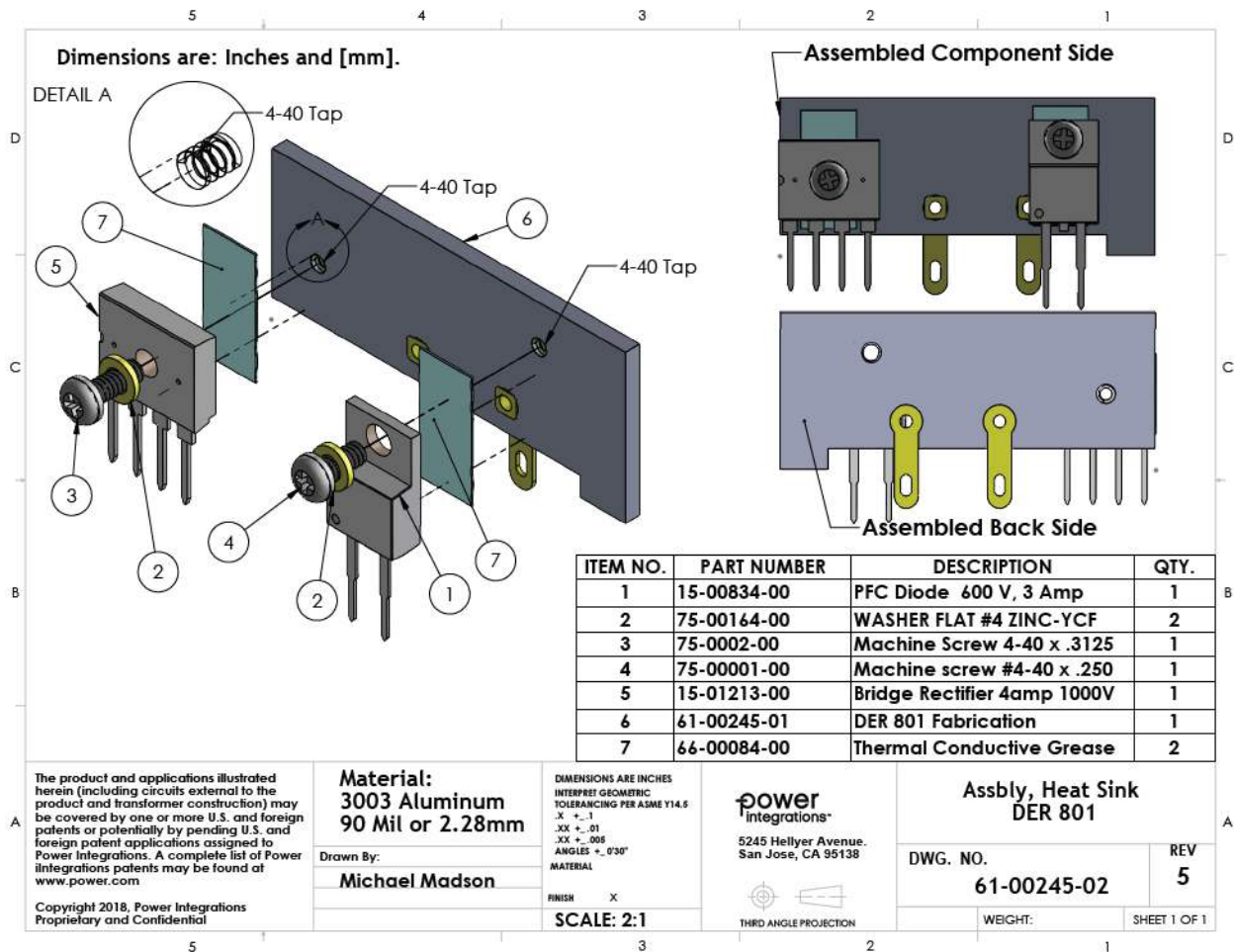

13 Performance Data

All measurements were performed at room temperature at 300 s soak time.

13.1 CV/CC Output Characteristic Curve

CV/CC was measured using CR E-Load for non-dimming application.

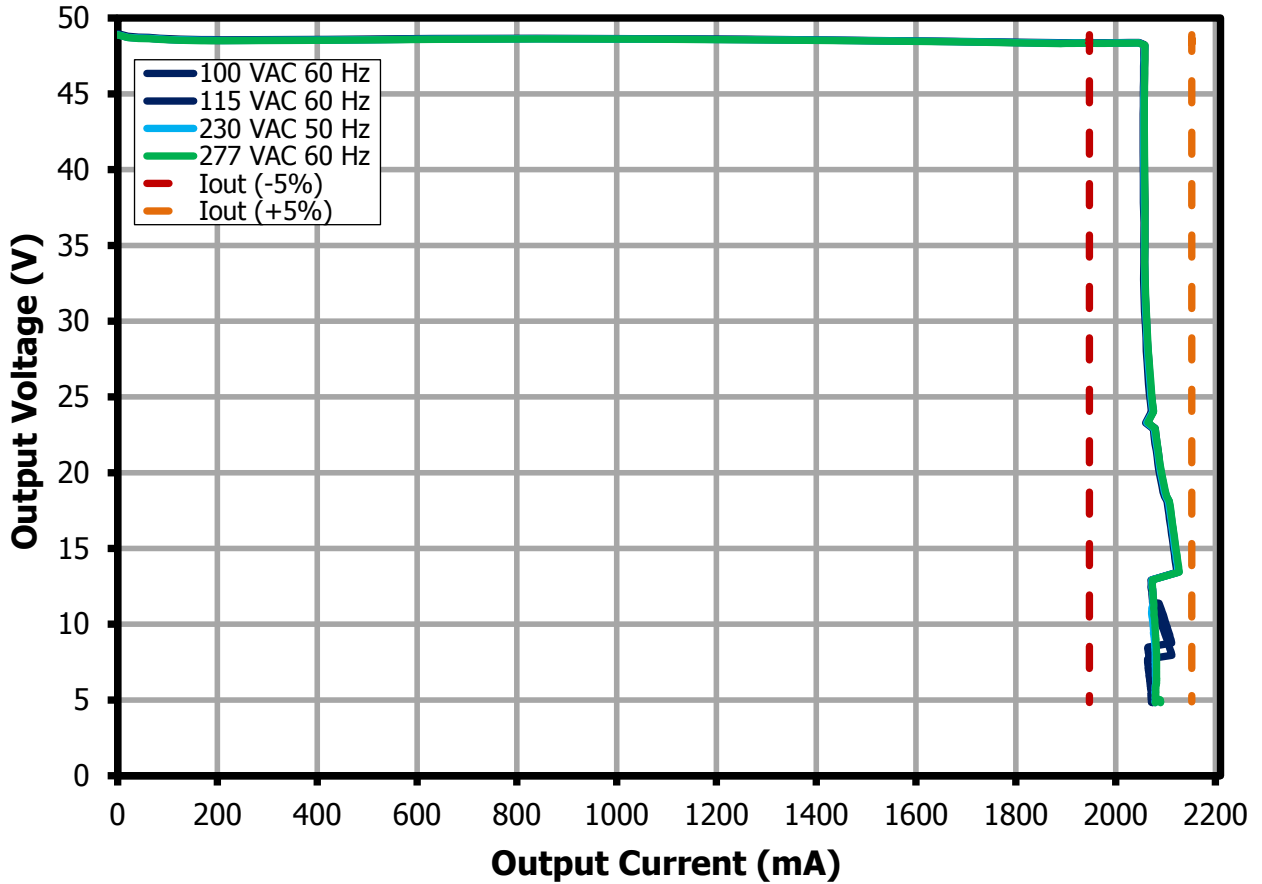

Figure 28 – CV/CC Curve.



13.2 System Efficiency

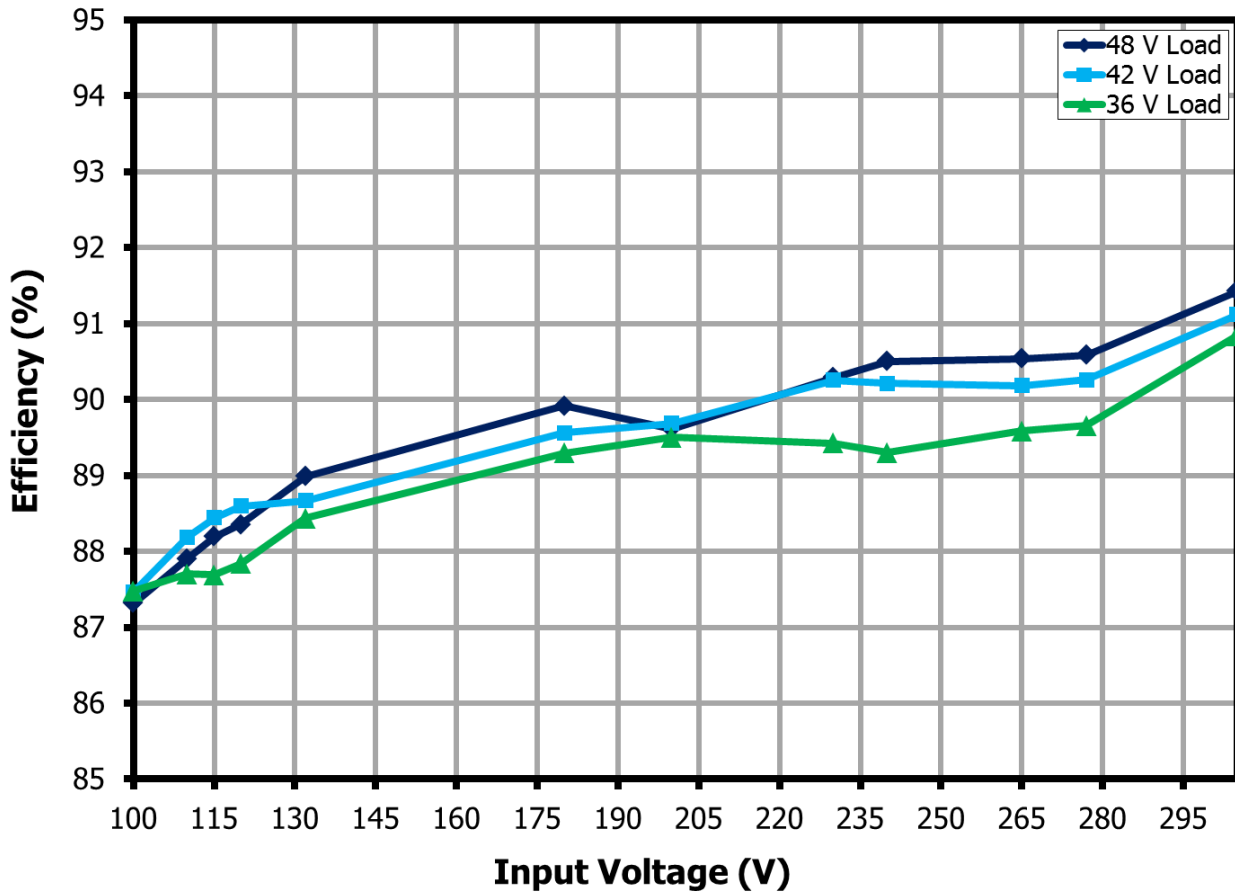

Figure 29 – Efficiency vs. Line and LED Load.

13.3 Output Current Regulation

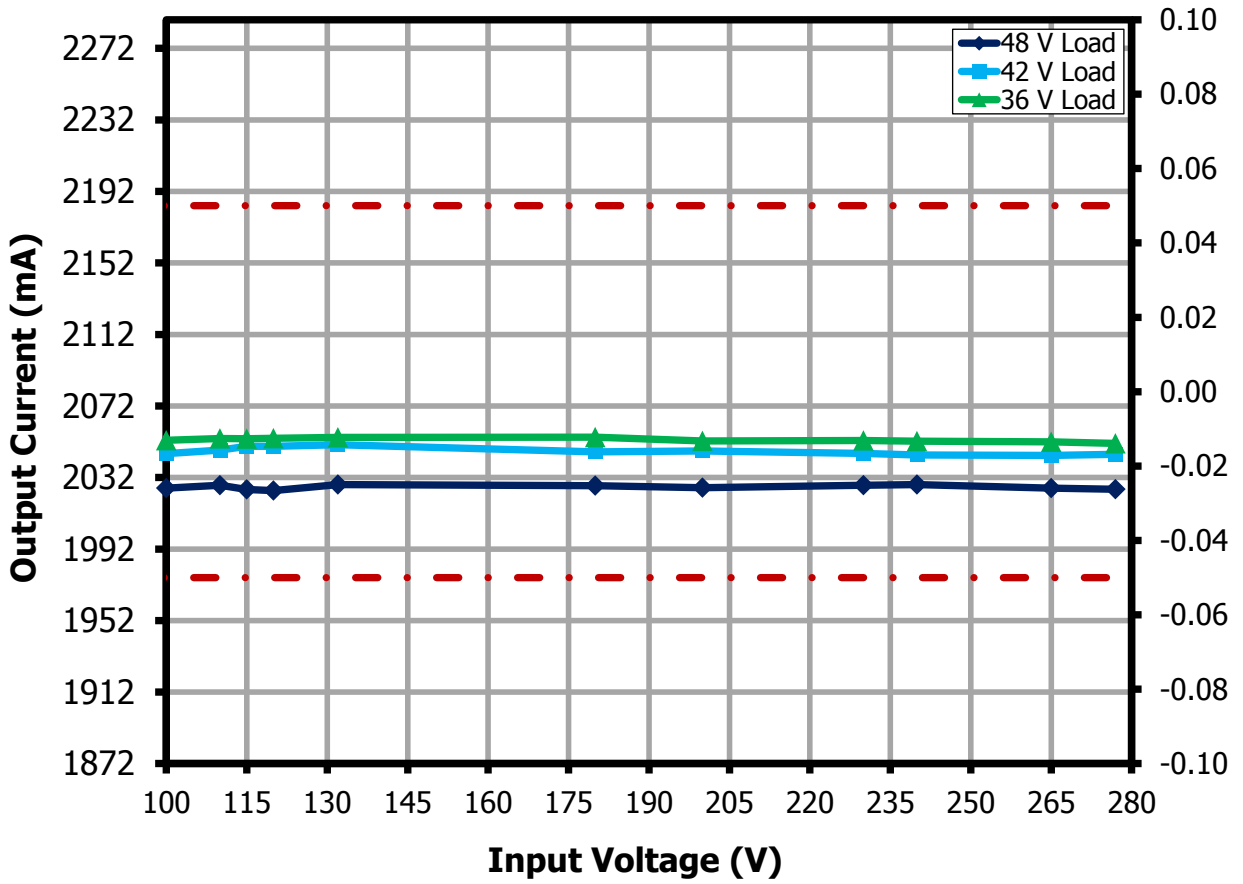

Figure 30 – Current Regulation vs. Line and LED Load.



13.4 Power Factor

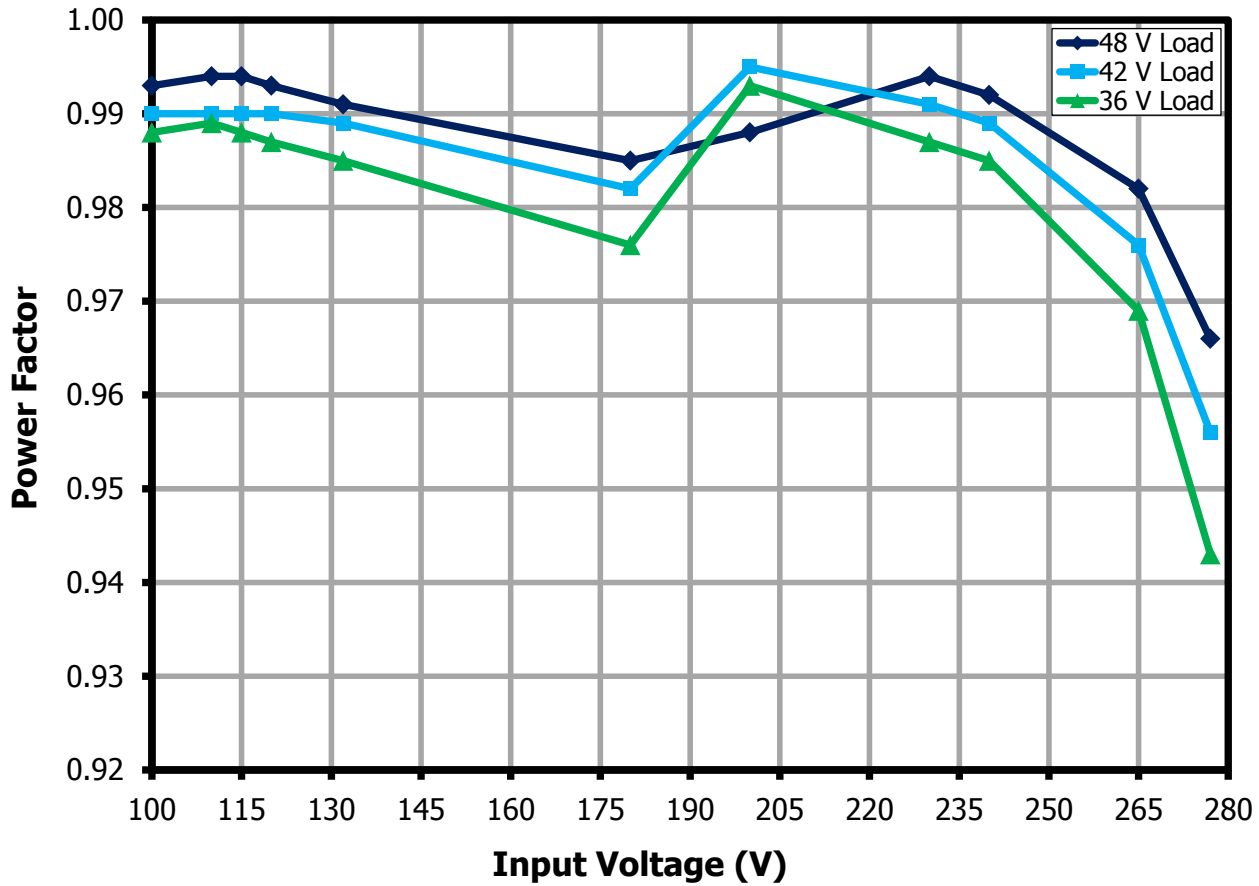

Figure 31 – Power Factor vs. Line and LED Load.

13.5 %ATHD

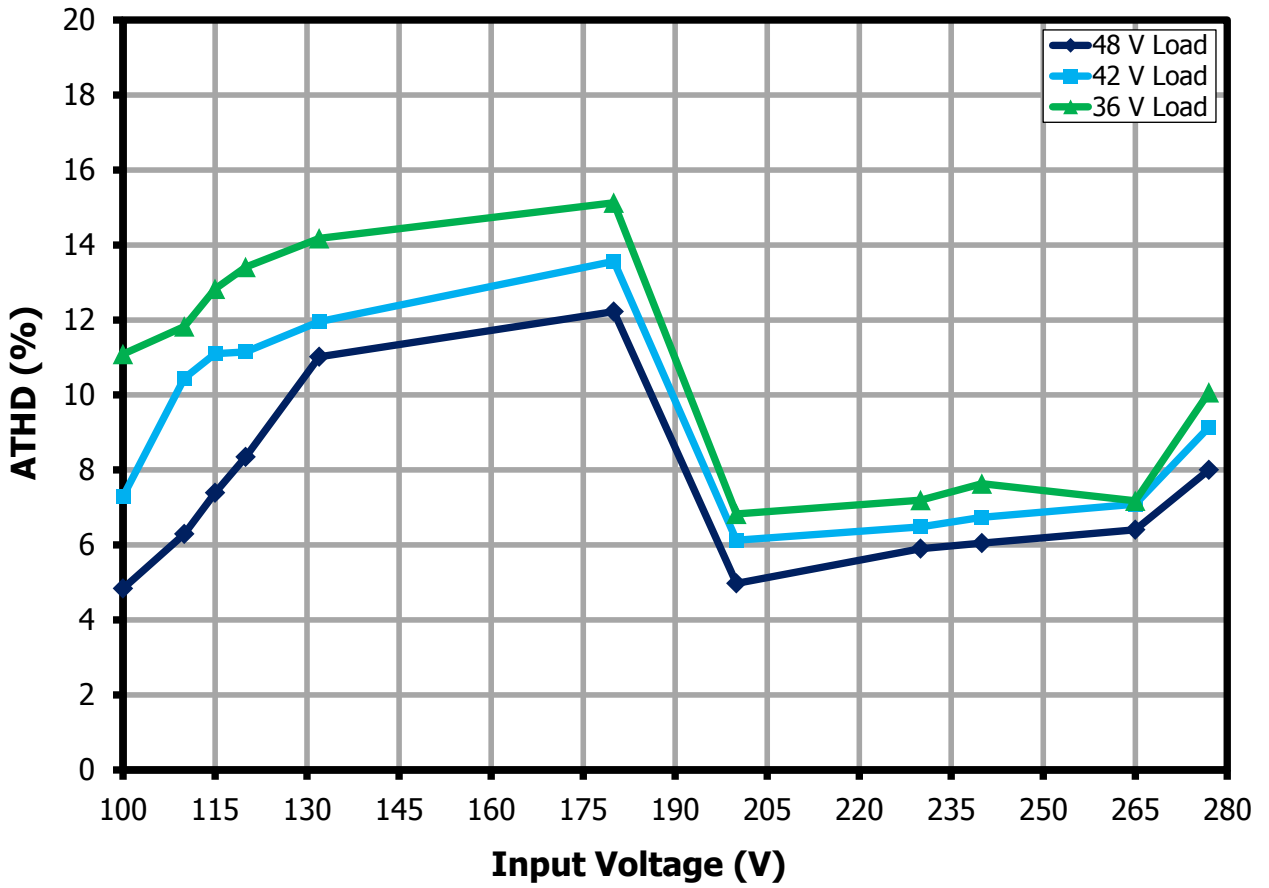

Figure 32 – %ATHD vs. Line and LED Load.



13.6 Individual Harmonic Content at 48 V LED Load

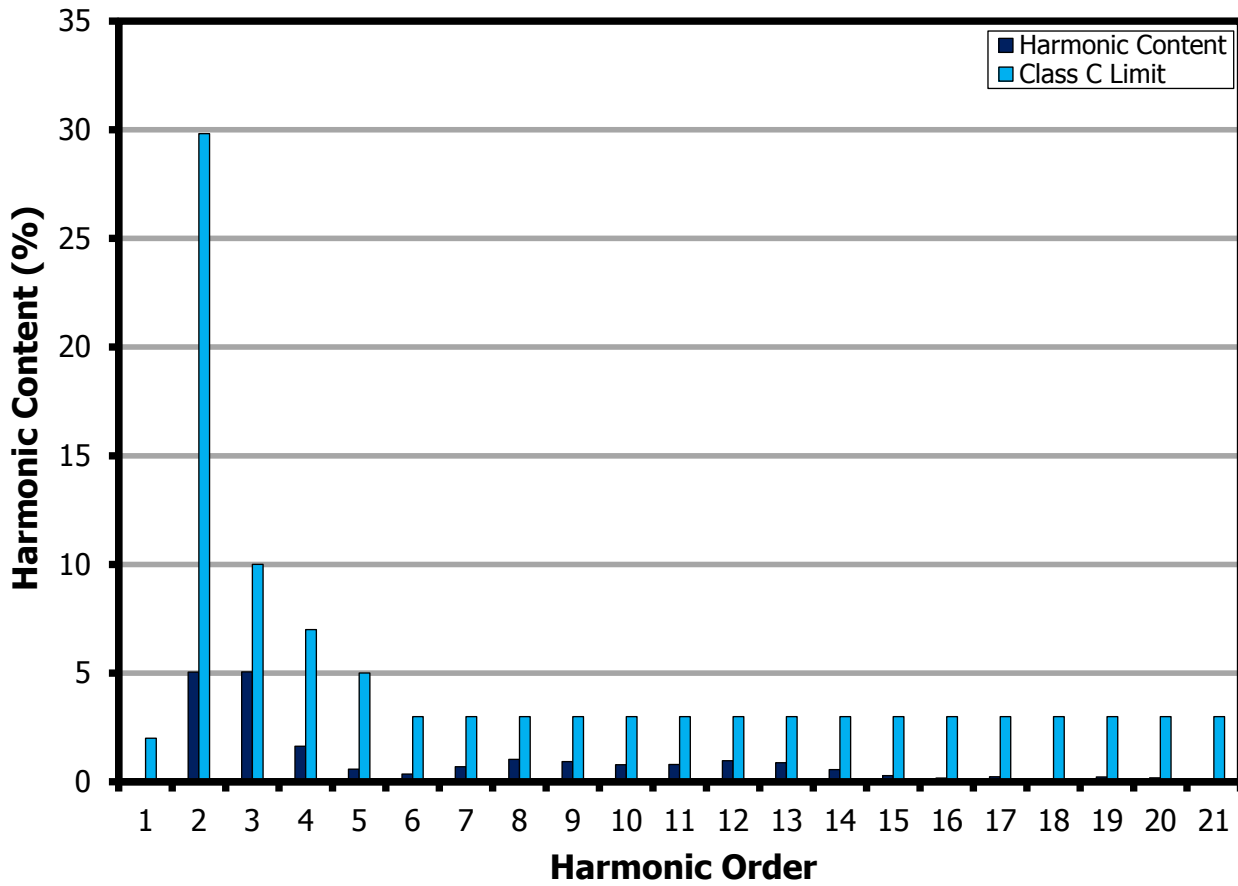

Figure 33 – 48 V LED Load Input Current Harmonics at 120 VAC, 60 Hz.

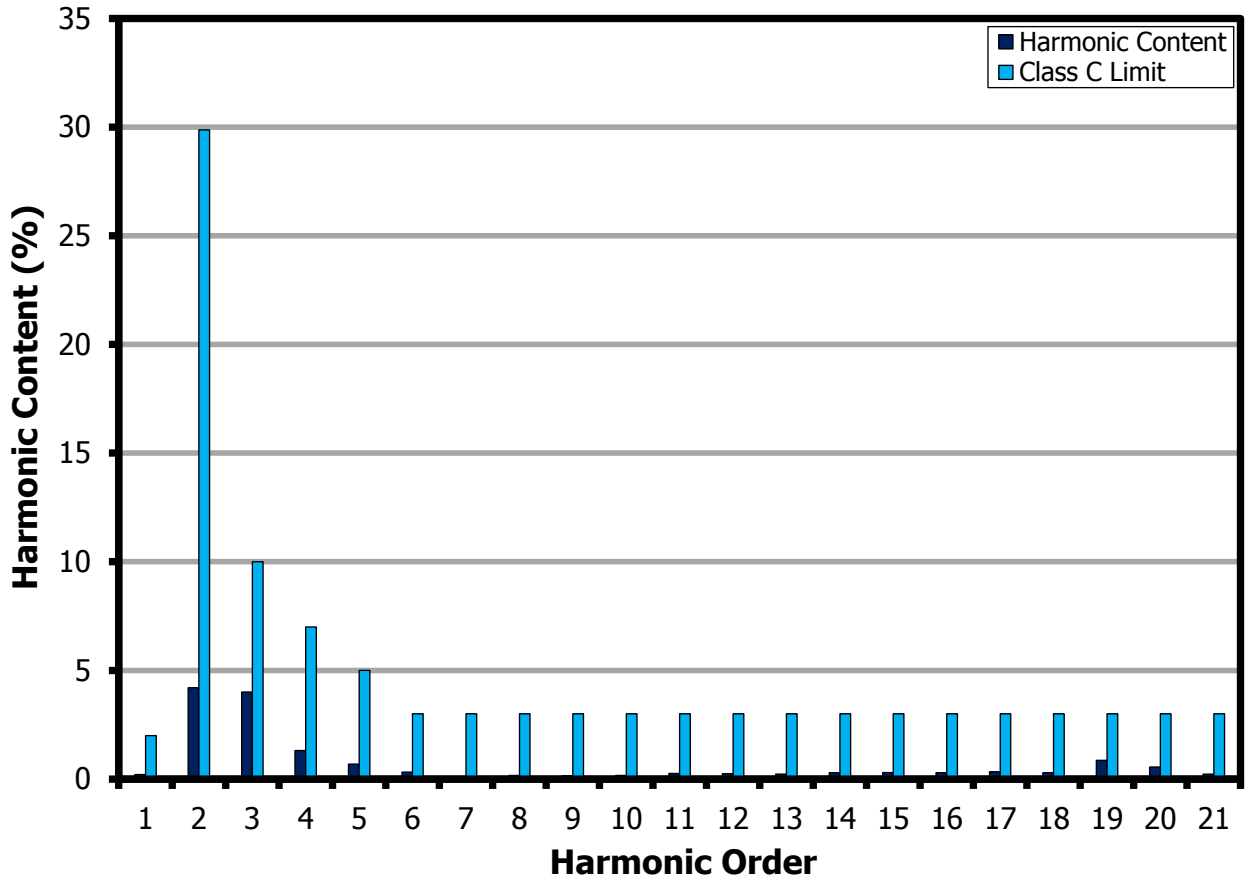

Figure 34 – 48 V LED Load Input Current Harmonics at 230 VAC, 50 Hz.



13.7 No-Load Input Power

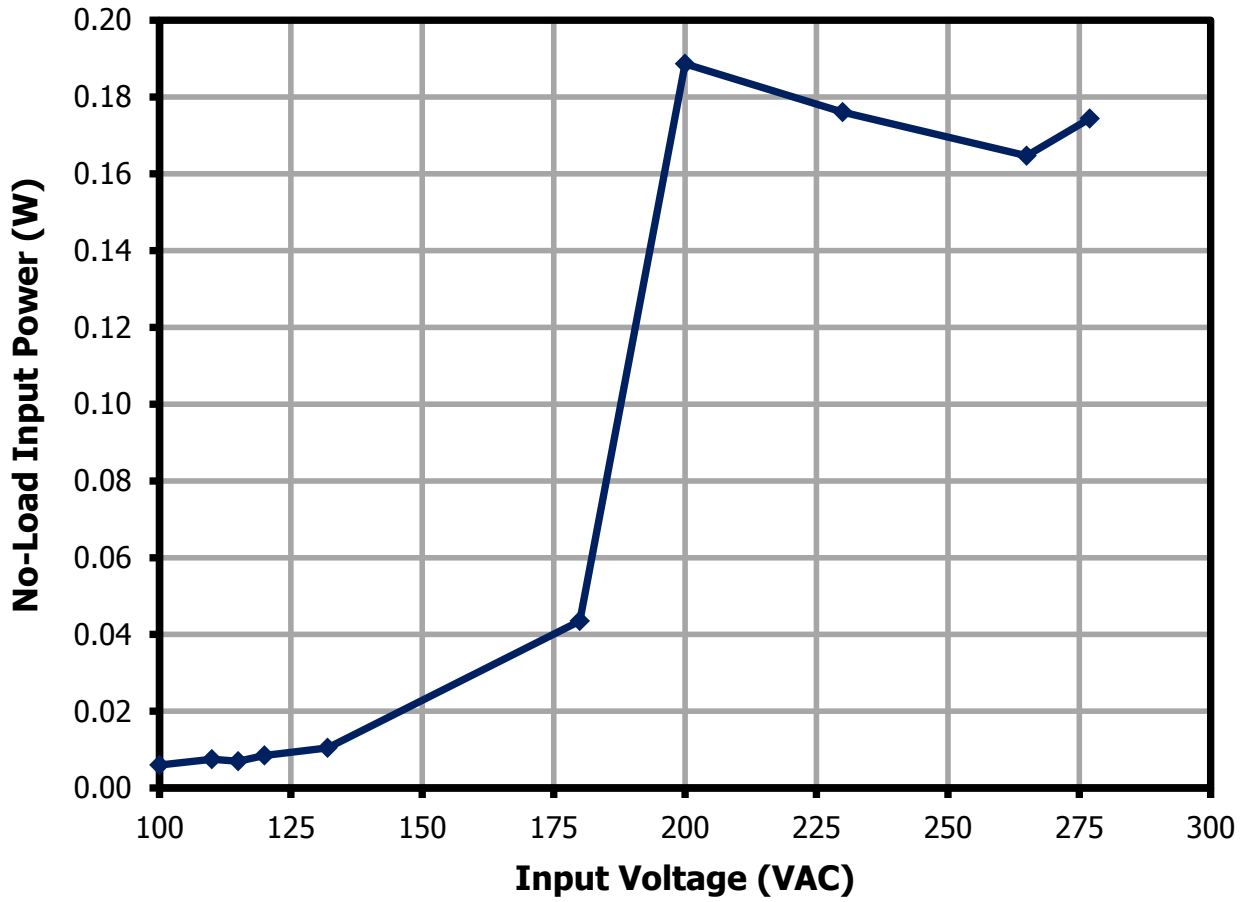

Figure 35 – No-Load Input Power vs. Line.

14 Test Data

14.1 48 V LED Load

Input		Input Measurement					LED Load Measurement			Efficiency (%)
VAC (V _{RMS})	Freq (Hz)	V _{IN} (V _{RMS})	I _{IN} (mA _{RMS})	P _{IN} (W)	PF	%ATHD	V _{OUT} (V _{DC})	I _{OUT} (mA _{DC})	P _{OUT} (W)	
100	60	99.64	1129.3	111.67	0.993	4.84	48.13	2026.1	97.51	87.32
110	60	109.6	1019.3	111.02	0.994	6.29	48.13	2027.7	97.59	87.90
115	60	114.66	970	110.53	0.994	7.39	48.13	2025.3	97.48	88.19
120	60	119.63	928.3	110.31	0.993	8.35	48.14	2024.7	97.46	88.35
132	60	131.72	840.5	109.68	0.991	11.02	48.13	2028	97.6	88.99
180	50	179.7	613	108.51	0.985	12.22	48.12	2027.4	97.57	89.92
200	50	199.74	551.5	108.81	0.988	4.98	48.12	2026.3	97.51	89.62
230	50	229.79	473.1	108.05	0.994	5.90	48.12	2027.7	97.56	90.29
240	50	239.81	453.2	107.81	0.992	6.05	48.11	2028.1	97.57	90.50
265	50	264.83	414.3	107.69	0.982	6.41	48.12	2026.1	97.5	90.54
277	50	276.85	402.5	107.6	0.966	7.99	48.13	2025.4	97.47	90.59
305	60	304.58	512.01	107.27	0.688	8.53	48.03	2041.9	98.07	91.42

14.2 42 V LED Load

Input		Input Measurement					LED Load Measurement			Efficiency (%)
VAC (V _{RMS})	Freq (Hz)	V _{IN} (V _{RMS})	I _{IN} (mA _{RMS})	P _{IN} (W)	PF	%ATHD	V _{OUT} (V _{DC})	I _{OUT} (mA _{DC})	P _{OUT} (W)	
100	60	99.7	999.1	98.6	0.99	7.30	42.17	2045.3	86.24	87.47
110	60	109.66	902	97.94	0.99	10.45	42.19	2047.3	86.37	88.19
115	60	114.72	860.2	97.67	0.99	11.10	42.15	2049.5	86.38	88.44
120	60	119.69	823	97.5	0.99	11.15	42.14	2049.5	86.38	88.60
132	60	131.77	748.5	97.51	0.989	11.95	42.17	2050.3	86.46	88.67
180	50	179.74	546.3	96.35	0.982	13.57	42.17	2046.4	86.29	89.56
200	50	199.78	484.5	96.3	0.995	6.13	42.20	2046.8	86.37	89.69
230	50	229.83	419.5	95.55	0.991	6.48	42.16	2045.5	86.24	90.26
240	50	239.85	401.9	95.32	0.989	6.74	42.06	2044.6	85.99	90.21
265	50	264.87	368.8	95.34	0.976	7.09	42.06	2044.4	85.98	90.18
277	50	276.89	360.2	95.38	0.956	9.14	42.10	2045	86.09	90.26
305	60	304.8	486.1	98.61	0.666	10.82	42.48	2115.1	89.85	91.12

14.3 36 V LED Load

Input		Input Measurement					LED Load Measurement			Efficiency (%)
VAC (V _{RMS})	Freq (Hz)	V _{IN} (V _{RMS})	I _{IN} (mA _{RMS})	P _{IN} (W)	PF	%ATHD	V _{OUT} (V _{DC})	I _{OUT} (mA _{DC})	P _{OUT} (W)	
100	60	99.75	867.3	85.48	0.988	11.09	36.43	2052.8	74.78	87.48
110	60	109.7	785.3	85.18	0.989	11.83	36.37	2053.8	74.71	87.71
115	60	114.76	750.2	85.03	0.988	12.83	36.31	2053.7	74.56	87.69
120	60	119.73	718.2	84.84	0.987	13.41	36.28	2053.9	74.52	87.84
132	60	131.81	649.4	84.28	0.985	14.18	36.28	2054.4	74.54	88.44
180	50	179.77	476.5	83.6	0.976	15.12	36.33	2054.6	74.65	89.29
200	50	199.81	420	83.29	0.993	6.83	36.32	2052.5	74.55	89.50
230	50	229.85	367.3	83.36	0.987	7.19	36.31	2052.7	74.54	89.42
240	50	239.87	353.6	83.55	0.985	7.64	36.36	2052.3	74.61	89.30
265	50	264.89	324	83.12	0.969	7.18	36.29	2052	74.46	89.59
277	50	276.91	318.3	83.11	0.943	10.07	36.33	2051.1	74.52	89.66
305	60	305.27	417.35	84.75	0.665	12.06	36.38	2116.5	76.99	90.84

14.4 No-Load

Input		Input Measurement			V _{OUT}
VAC (V _{RMS})	Freq (Hz)	V _{IN} (V _{RMS})	I _{IN} (mA _{RMS})	P _{IN} (W)	V (V _{DC})
100	60	99.98	23.82	0.006	48.52
110	60	110.00	24.81	0.008	48.52
115	60	114.97	25.30	0.007	48.52
120	60	120.02	25.83	0.008	48.52
132	60	132.01	27.12	0.010	48.51
180	50	180.05	29.07	0.044	48.52
200	50	200.01	34.60	0.189	48.52
230	50	230.06	34.68	0.176	48.52
265	50	265.03	38.74	0.165	48.52
277	60	277.13	46.93	0.174	48.52

14.5 Individual Harmonic Content at 120 VAC and 48 V LED Load

V_{IN} (V_{RMS})	Freq (Hz)	I_{IN} (mA_{RMS})	P_{IN} (W)	PF	%THD
119.76	60	957.00	113.90	0.99	8.25
Harmonic Content			Class C Limit		
nth Order	mA Content	% Content	mA Limit <25 W	% Limit >25 W	Remarks
1	963.00				
2	1.00	0.10		2.0	pass
3	48.60	5.05	390.39	29.82	pass
5	48.70	5.06	218.16	10.0	pass
7	15.70	1.63	114.82	7.0	pass
9	5.60	0.58	57.41	5.0	pass
11	3.40	0.35	40.19	3.0	pass
13	6.70	0.70	34.00	3.0	pass
15	9.90	1.03	29.47	3.0	pass
17	8.90	0.92	26.00	3.0	pass
19	7.50	0.78	23.27	3.0	pass
21	7.60	0.79	21.05	3.0	pass
23	9.30	0.97	19.22	3.0	pass
25	8.40	0.87	17.68	3.0	pass
27	5.40	0.56	16.37	3.0	pass
29	2.70	0.28	15.24	3.0	pass
31	1.60	0.17	14.26	3.0	pass
33	2.20	0.23	13.40	3.0	pass
35	1.20	0.12	12.63	3.0	pass
37	2.10	0.22	11.95	3.0	pass
39	1.70	0.18	11.33	3.0	pass

14.6 Individual Harmonic Content at 230 VAC and 48 V LED Load

V_{IN} (V_{RMS})	Freq (Hz)	I_{IN} (mA_{RMS})	P_{IN} (W)	PF	%THD
229.91	50	489.18	111.97	1.00	6.17
Harmonic Content			Class C Limit		
nth Order	mA Content	% Content	mA Limit <25 W	% Limit >25 W	Remarks
1	483.75				
2	0.98	0.20		2.0	pass
3	20.32	4.20	380.70	29.87	pass
5	19.40	4.01	212.74	10.0	pass
7	6.38	1.32	111.97	7.0	pass
9	3.35	0.69	55.99	5.0	pass
11	1.54	0.32	39.19	3.0	pass
13	0.40	0.08	33.16	3.0	pass
15	0.81	0.17	28.74	3.0	pass
17	0.75	0.16	25.36	3.0	pass
19	0.79	0.16	22.69	3.0	pass
21	1.23	0.25	20.53	3.0	pass
23	1.22	0.25	18.74	3.0	pass
25	1.08	0.22	17.24	3.0	pass
27	1.39	0.29	15.97	3.0	pass
29	1.46	0.30	14.86	3.0	pass
31	1.41	0.29	13.91	3.0	pass
33	1.62	0.33	13.06	3.0	pass
35	1.41	0.29	12.32	3.0	pass
37	4.18	0.86	11.65	3.0	pass
39	2.70	0.56	11.05	3.0	pass

15 Dimming Performance

Dimming performance data were taken at room temperature.

15.1 Dimming Curve

15.1.1 0 V - 10 V Dimming Curve

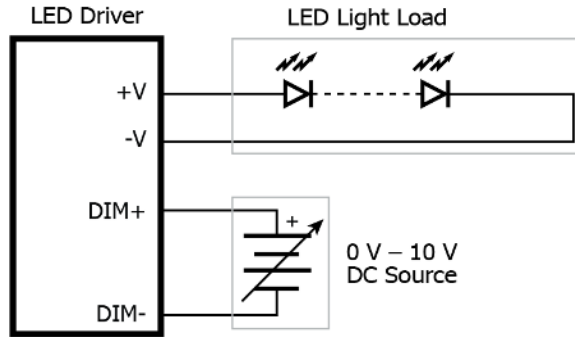

PI-8489-101117

Figure 36 – 0 V- 10 V Dimming Set-up.

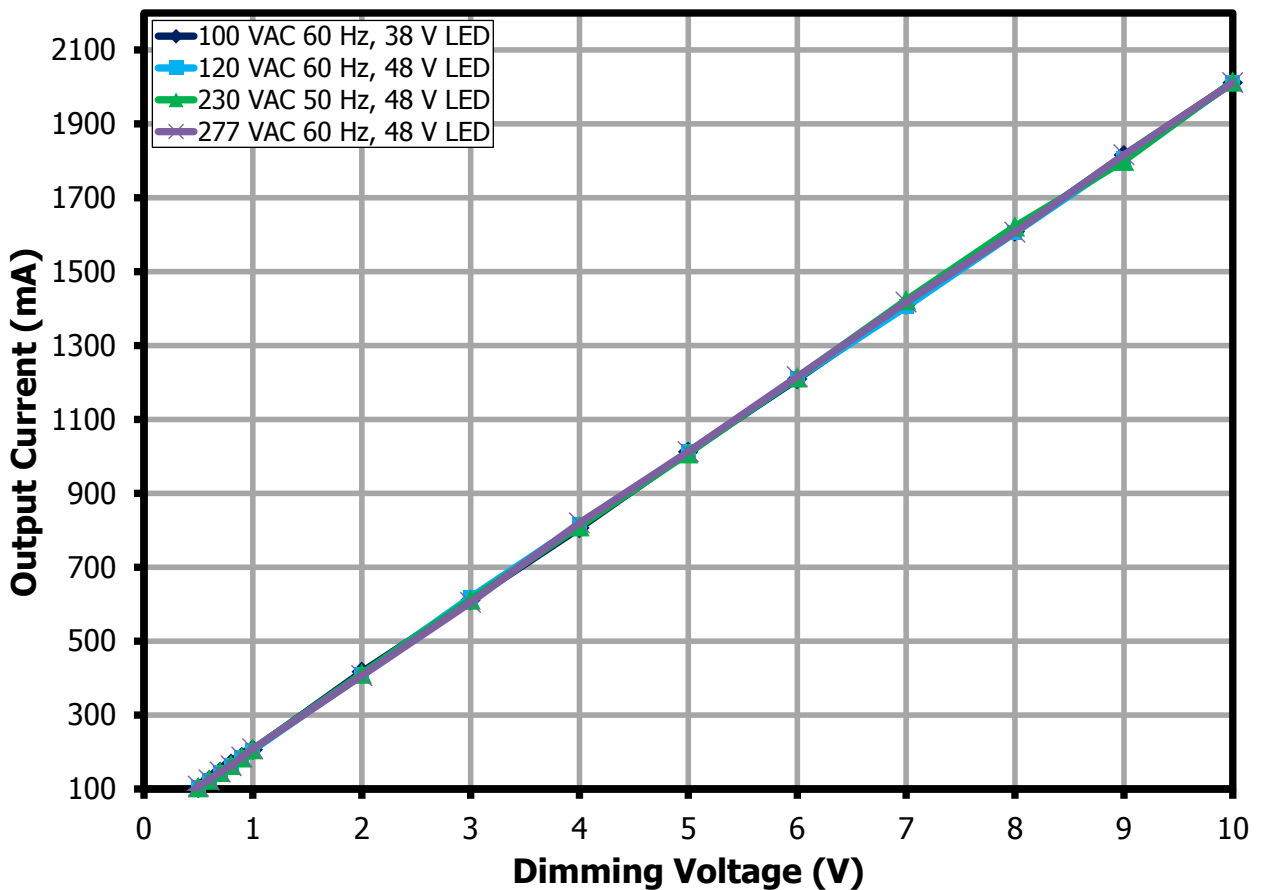

Figure 37 – 0 V - 10 V Dimming Curve at 48 V LED Load.



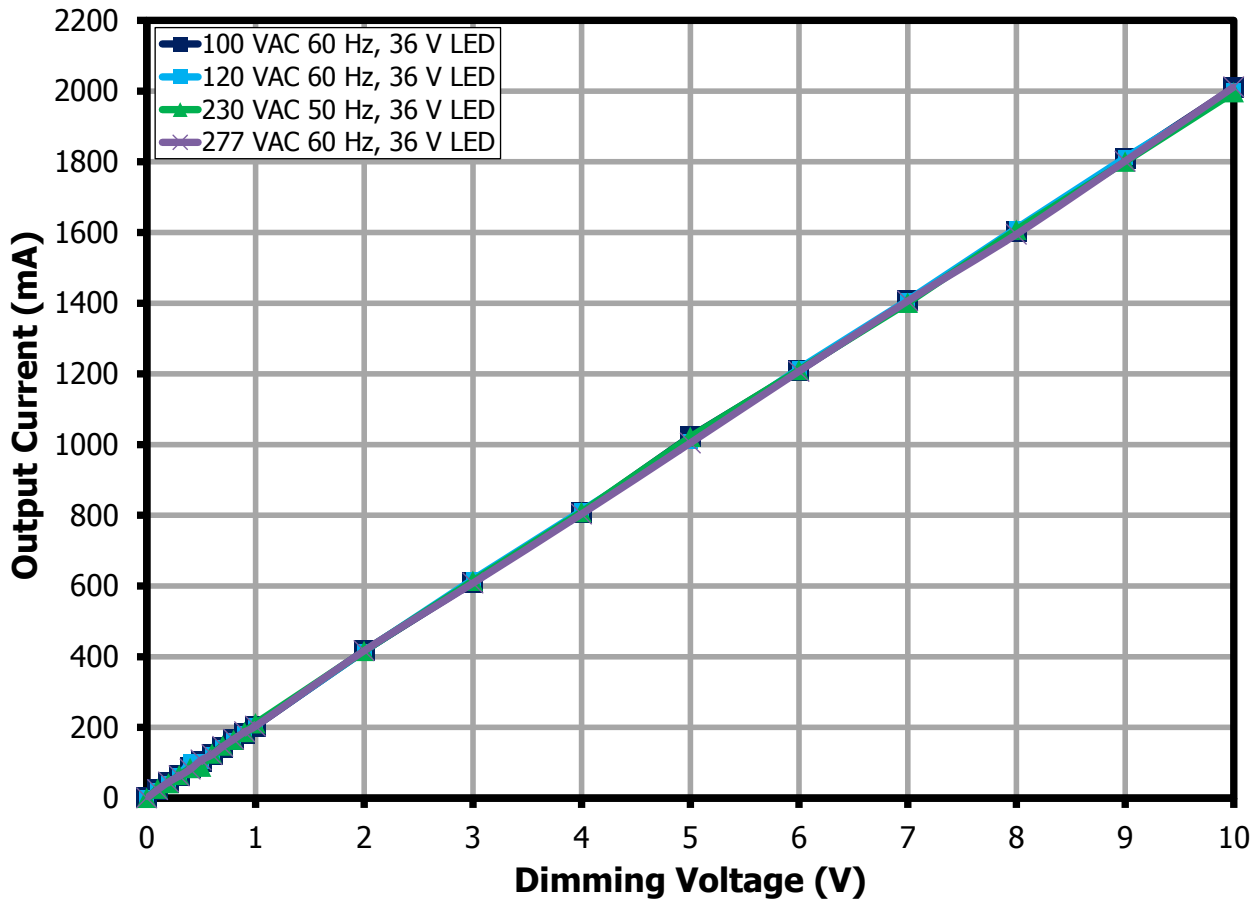
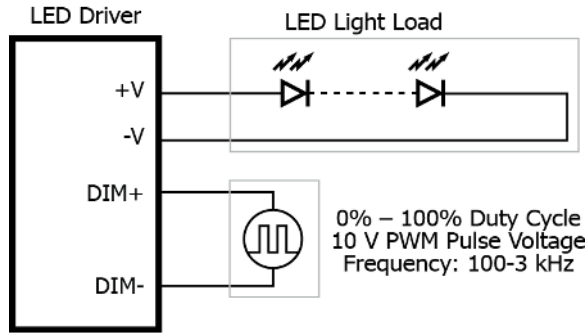

Figure 38 – 0 V - 10 V Dimming Curve at 36 V LED Load.

15.1.2 10 V 1 kHz PWM Dimming Curve



PI-8490-101117

Figure 39 – 10 V, 1 KHz PWM Dimming Set-up.

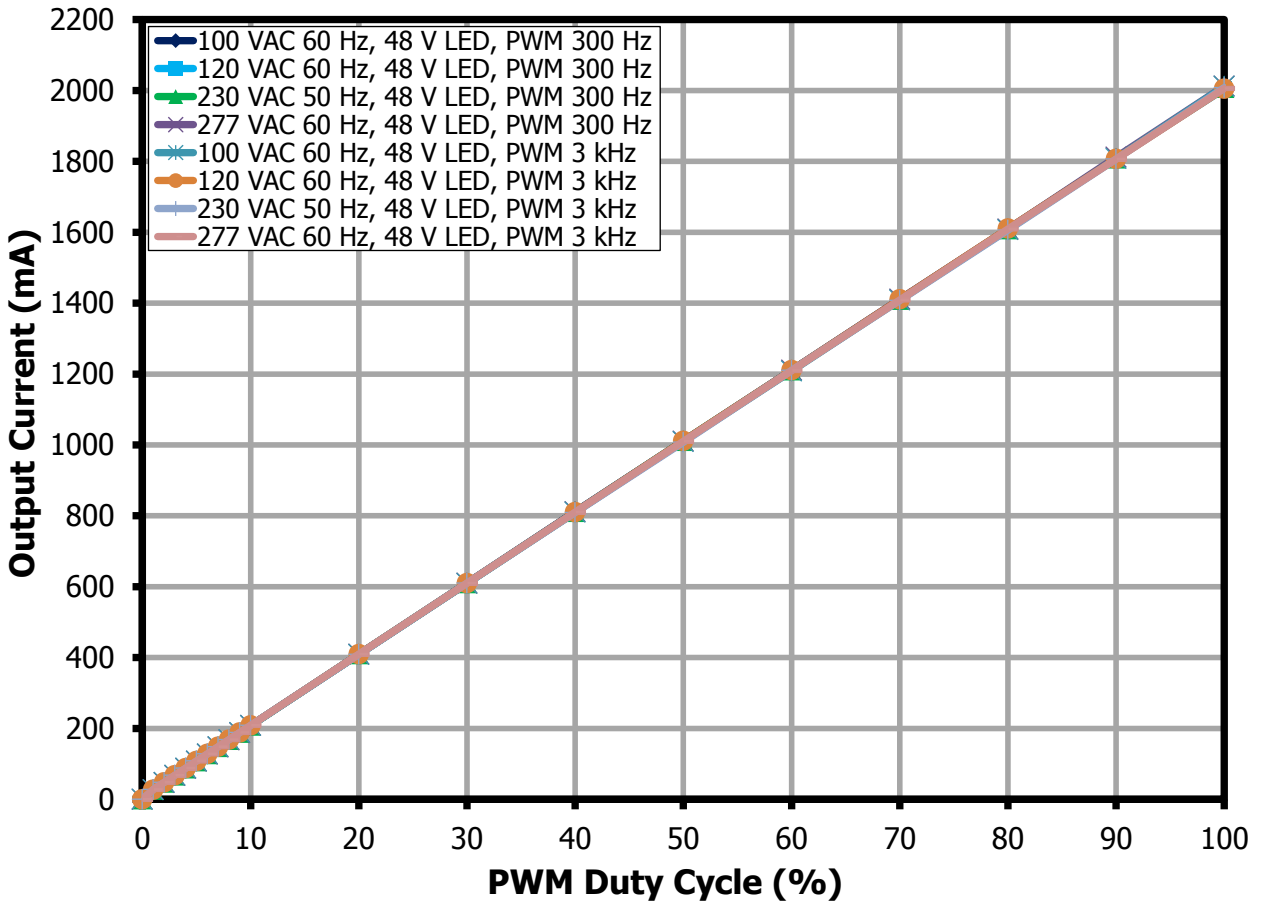

Figure 40 – 1 kHz, 10 V PWM Dimming Curve at 48 V LED Load.



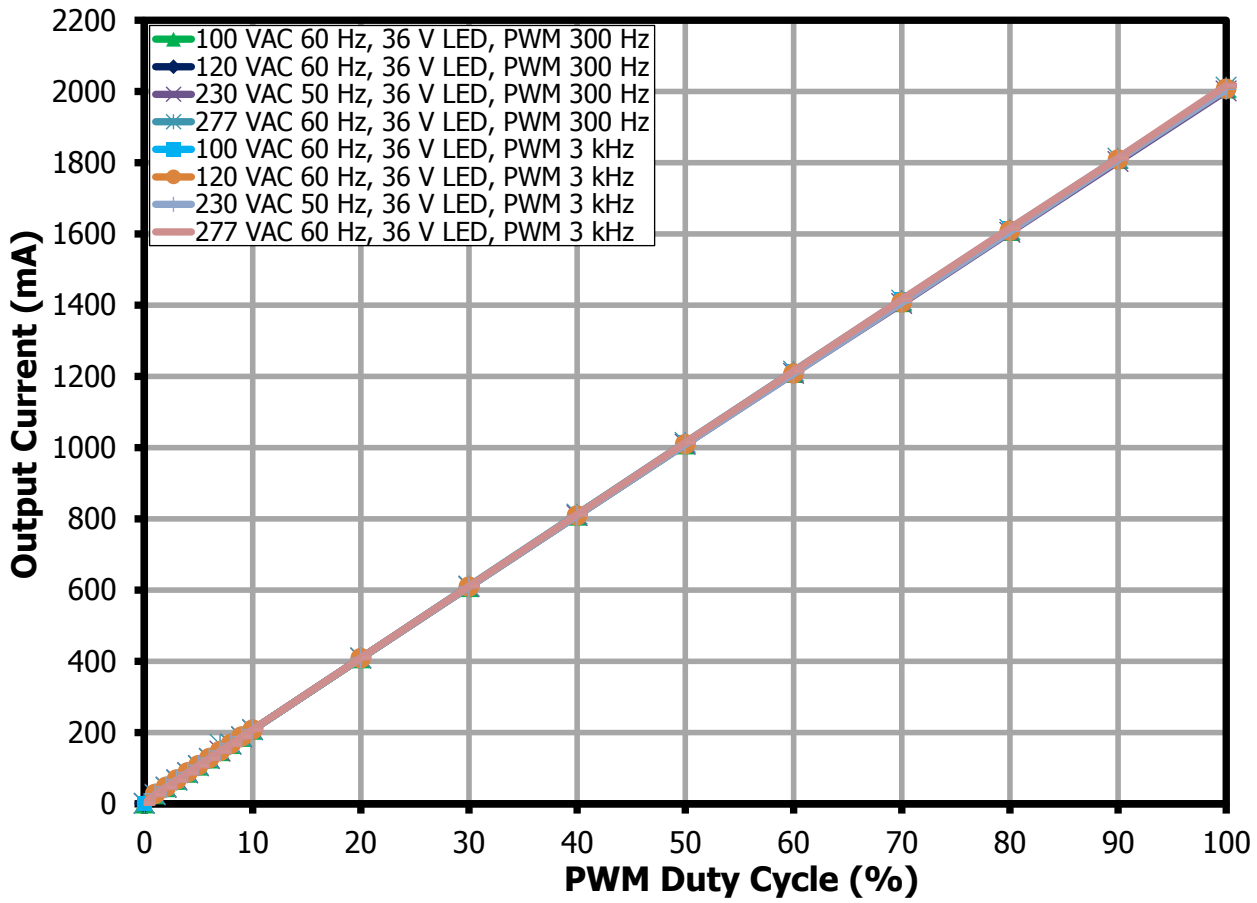
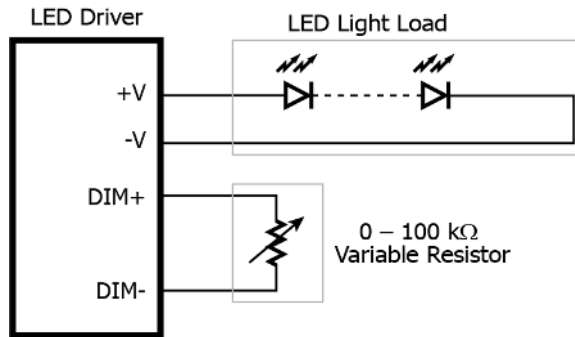

Figure 41 – 1 kHz, 10 V PWM Dimming Curve at 36 V LED Load.

15.1.3 Variable Resistor Dimming Curve



PI-8491-101117

Figure 42 – 0 Ω - 100 kΩ Variable Resistor Dimming Set-up.

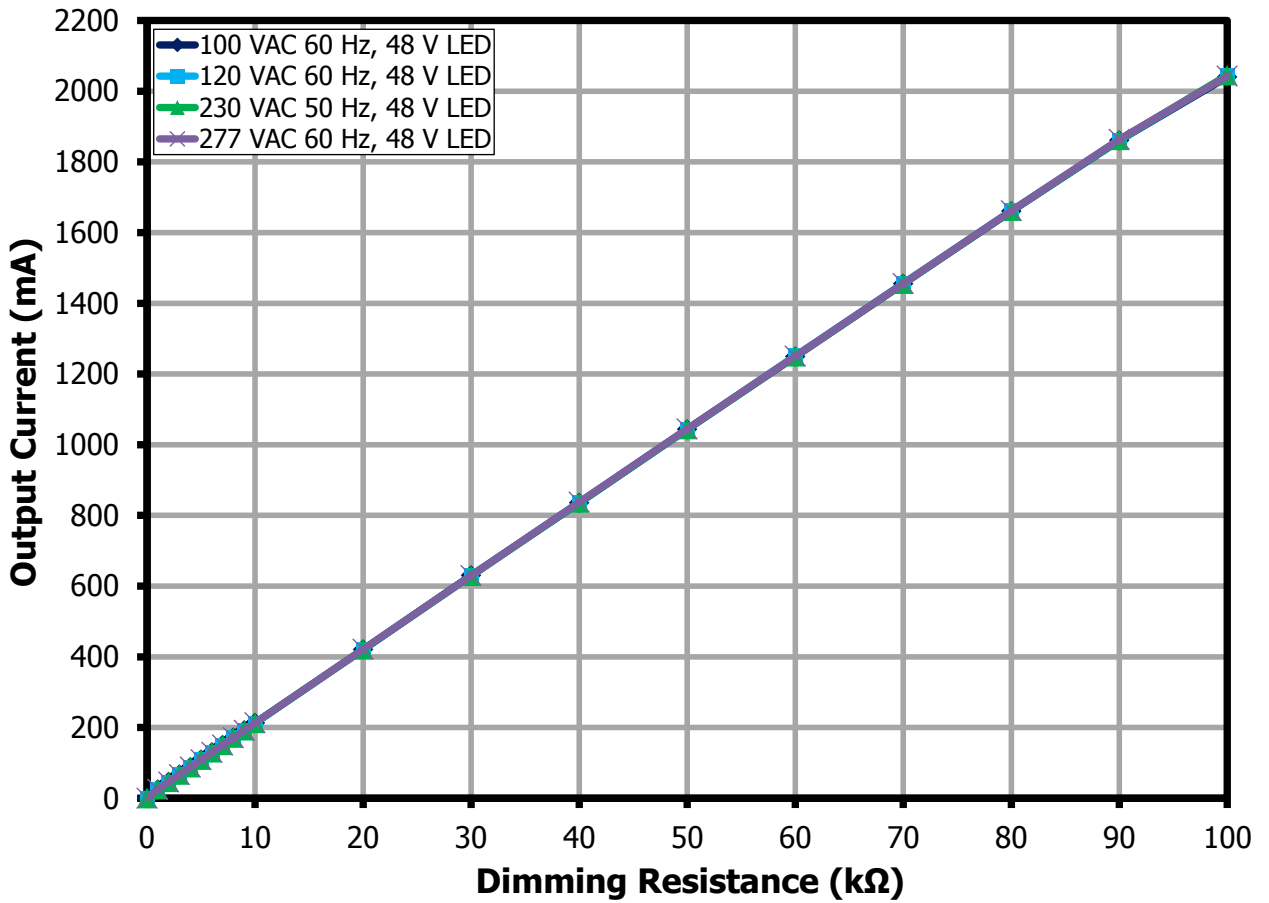

Figure 43 – 0 Ω - 100 kΩ Variable Resistor Dimming Curve at 48 V LED Load.



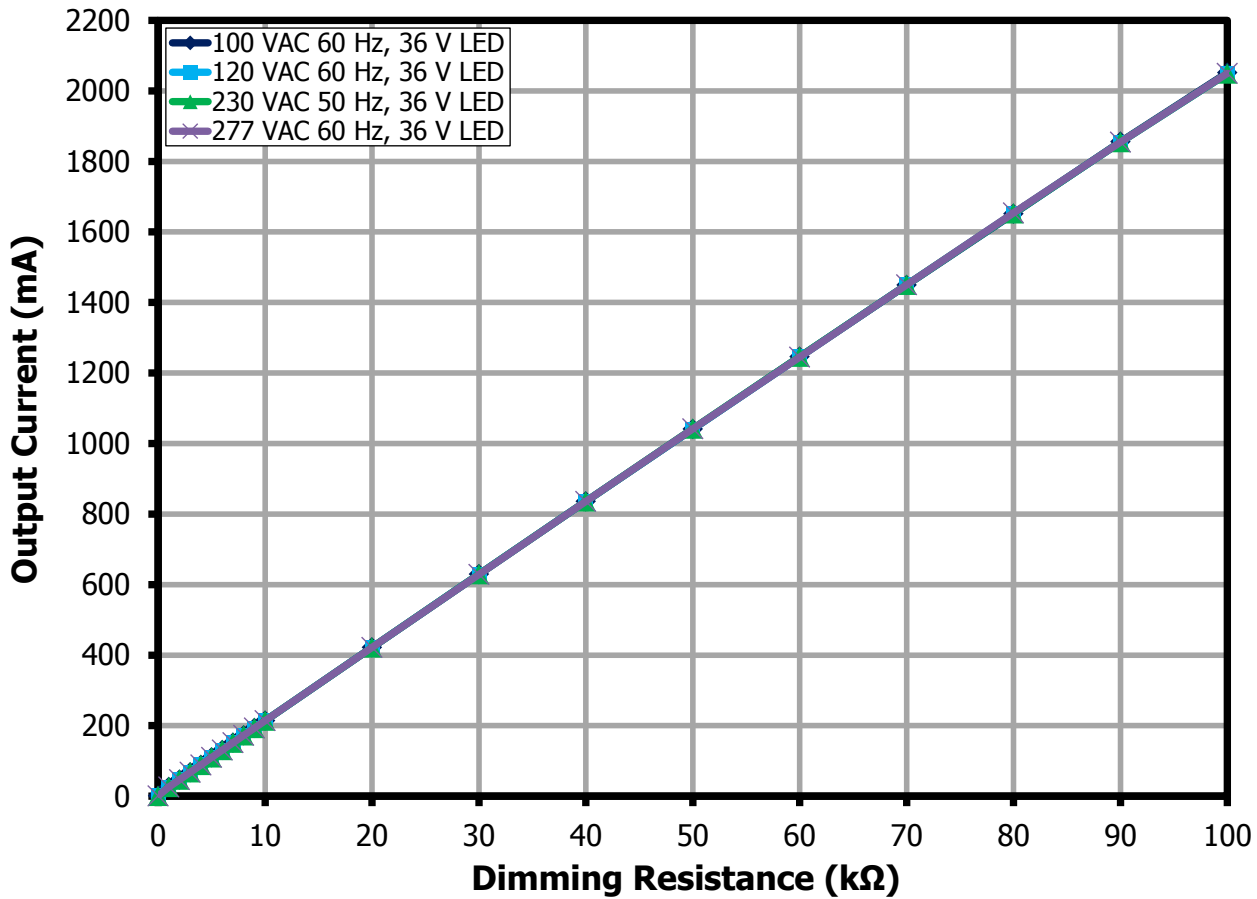

Figure 44 – 0 Ω - 100 kΩ Variable Resistor Dimming Curve at 36 V LED Load.

16 Thermal Performance

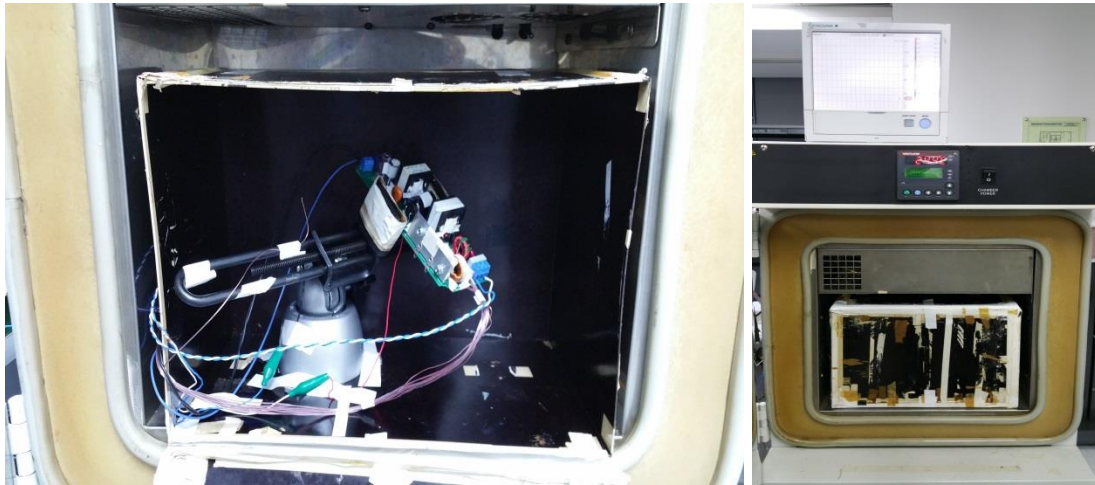

Figure 45 – Test Set-up Picture - Open Frame.

16.1 Thermal Scan at 25 °C Ambient

Unit in open frame was placed inside an enclosure to prevent airflow that might affect the thermal measurements. Ambient temperature inside enclosure is ~25 °C. Temperature was measured using type T thermocouple.

16.1.1 Thermal Scan at 100 VAC Full Load

Thermal scan was performed at worst case input voltage of 100 VAC at room ambient temperature with enclosure.

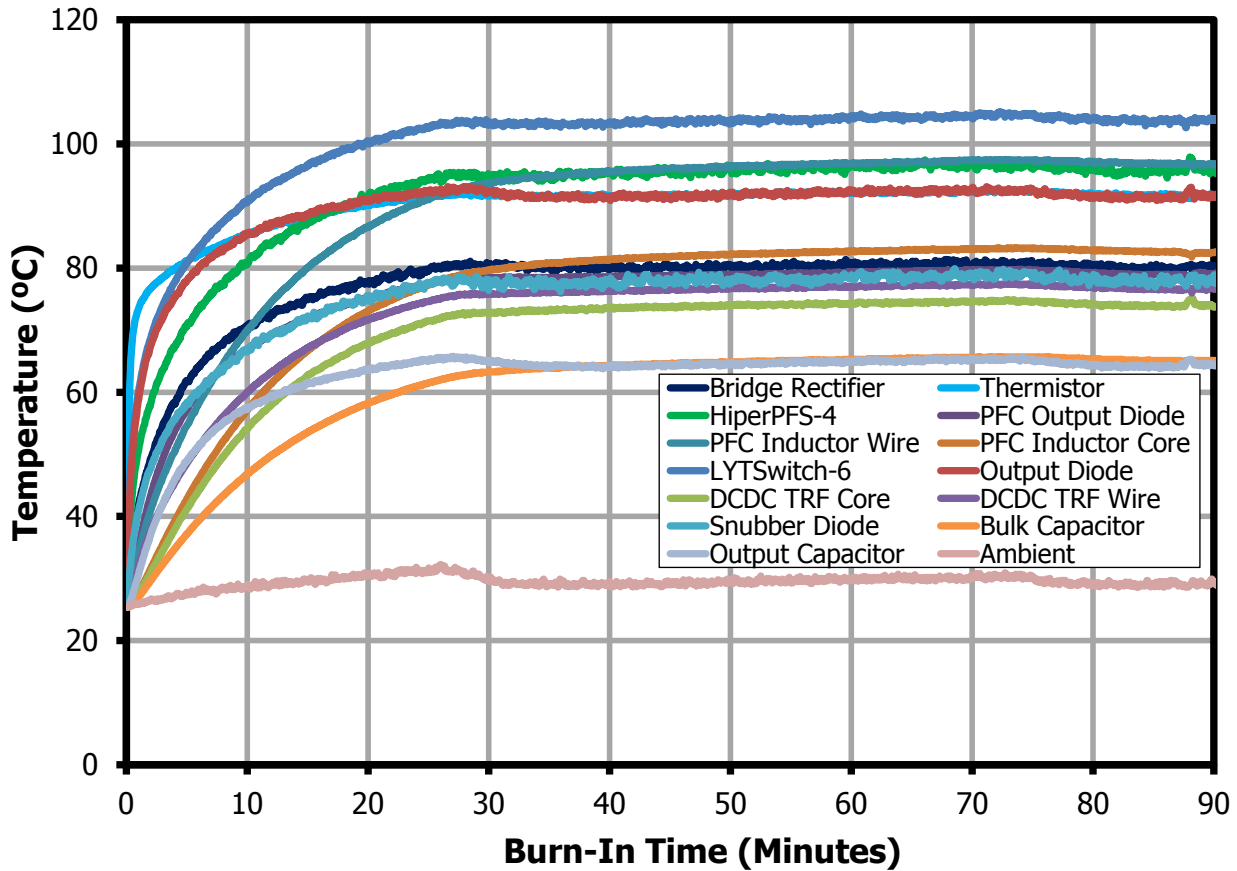

Figure 46 – Thermal Scan, 100 VAC Full Load – 25 °C Ambient Temperature.

No.	Ckt. Code	Description	Thermal Reading (°C), 25 °C Ambient
			Open-Frame
			100 VAC 60 Hz
1	BR1	Bridge Diode	80.4
2	RT1	Input Thermistor	88.1
3	U2	HiperPFS-4	95.9
4	D5	PFC Output Diode	79.1
5	T2 Wire	PFC Inductor Winding	95.8
6	T2 Core	PFC Inductor Core	82.5
7	U4	LYTSwitch-6	103.9
8	D12	Output Diode	91.4
9	T3 Wire	DCDC Main Transformer Winding	76.7
10	T3 Core	DCDC Main Transformer Core	73.7
11	D3	DCDC Primary Snubber Clamp Diode	78.5
12	C13	PFC Bulk Capacitor	65.1
13	C7	Output Capacitor	64.4
14	Amb	Ambient Temp	29.3

16.2 Thermal Performance at 40 °C Ambient

Unit in open frame was placed inside an enclosure to prevent airflow that might affect the thermal measurements. Ambient temperature inside enclosure is 40 °C. Temperature was measured using type T thermocouple.

No.	Ckt. Code	Description	Thermal Reading (°C), 40 °C Ambient			
			Open-Frame			
			100 VAC 60 Hz	120 VAC 60 Hz	230 VAC 50 Hz	277 VAC 60 Hz
1	BR1	Bridge Diode	83.2	77	69.1	67.5
2	RT1	Input Thermistor	90.3	87.7	66.1	61.8
3	U2	HiperPFS-4	99	90.1	79.1	80.3
4	D5	PFC Output Diode	82.5	81.5	71.4	69.7
5	T2 Wire	PFC Inductor Winding	96.7	93	81.6	75.7
6	T2 Core	PFC Inductor Core	84.7	79.1	72.5	67.8
7	U4	LYTSwitch-6	114.2	113.2	114	113.4
8	D12	Output Diode	104.8	103.3	102.9	102.4
9	T3 Wire	DCDC Main Transformer Winding	85.1	82.3	84.4	84.2
10	T3 Core	DCDC Main Transformer Core	79.6	82	84.3	83.9
11	D3	DCDC Primary Snubber Clamp Diode	83.9	87	87.7	86.4
12	C13	PFC Bulk Capacitor	71.3	69.3	70	68.9
13	C7	Output Capacitor	77.3	75.6	75.5	75.2
14	Amb	Ambient Temp	40.2	40.8	40.5	40.5

17 Waveforms

17.1 Input Voltage and Input Current at 48 V LED Load

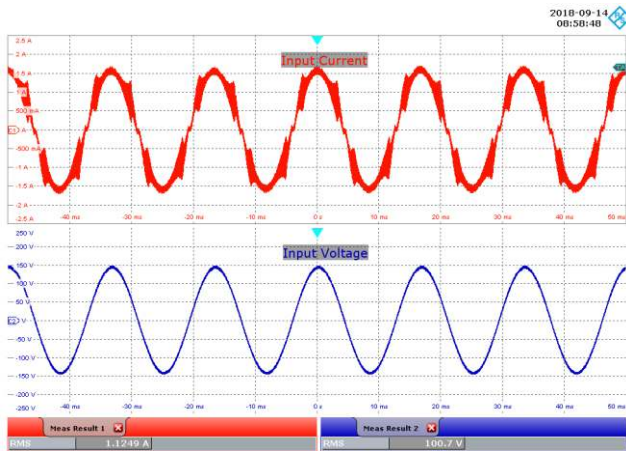

Figure 47 – 100 VAC, 48 V LED Load.
 Upper: I_{IN} , 500 mA / div.
 Lower: V_{IN} , 50 V / div., 10 ms / div.

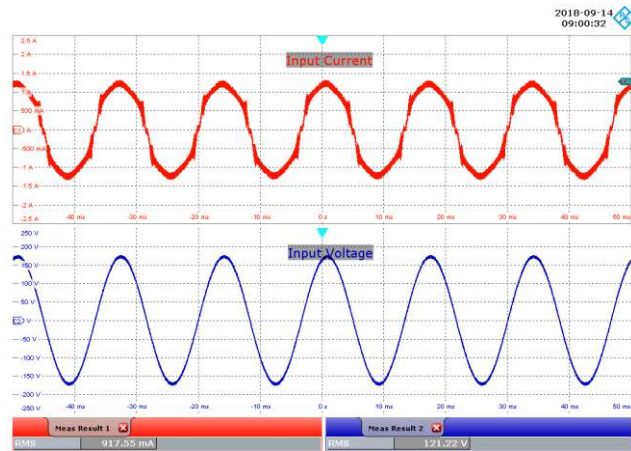

Figure 48 – 120 VAC, 48 V LED Load.
 Upper: I_{IN} , 500 mA / div.
 Lower: V_{IN} , 50 V / div., 10 ms / div.

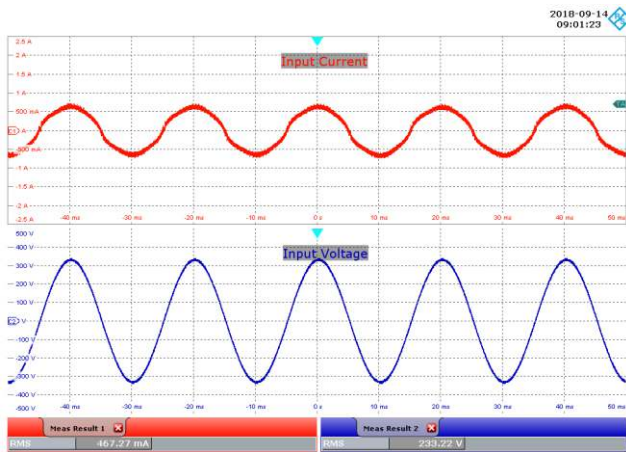

Figure 49 – 230 VAC, 48 V LED Load.
 Upper: I_{IN} , 500 mA / div.
 Lower: V_{IN} , 100 V / div., 10 ms / div.

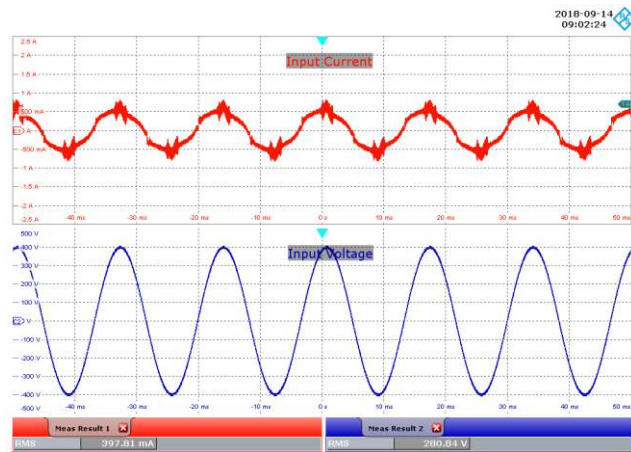

Figure 50 – 277 VAC, 48 V LED Load.
 Upper: I_{IN} , 500 mA / div.
 Lower: V_{IN} , 100 V / div., 10 ms / div.

17.2 Start-up Profile at 48 V LED Load

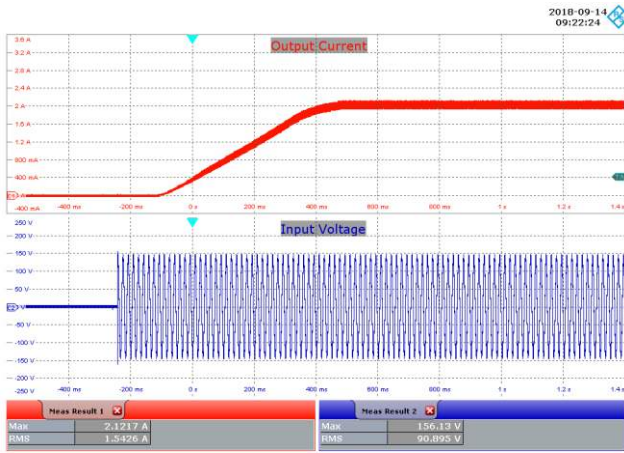

Figure 51 – 100 VAC, 48 V LED, Output Rise.
Upper: I_{OUT}, 400 mA / div.
Lower: V_{IN}, 50 V / div., 200 ms / div.

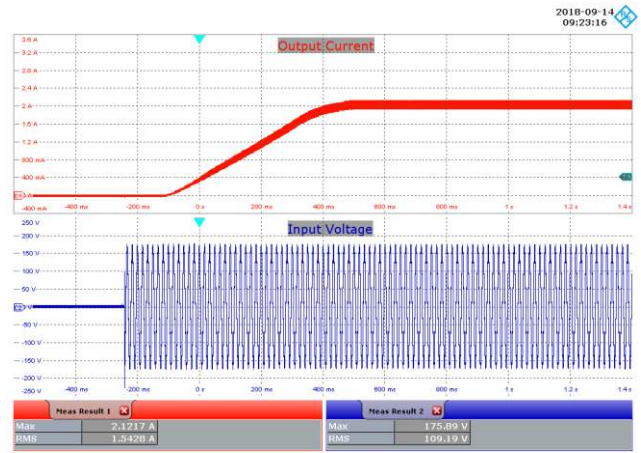

Figure 52 – 120 VAC, 48 V LED, Output Rise.
Upper: I_{OUT}, 400 mA / div.
Lower: V_{IN}, 50 V / div., 200 ms / div.

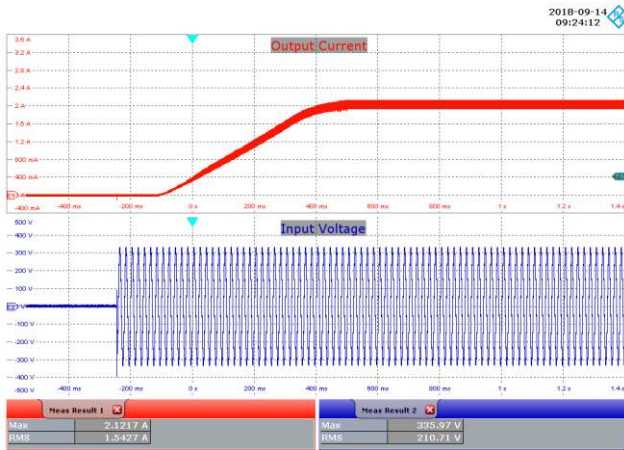

Figure 53 – 230 VAC, 48 V LED, Output Rise.
Upper: I_{OUT}, 400 mA / div.
Lower: V_{IN}, 100 V / div., 200 ms / div.

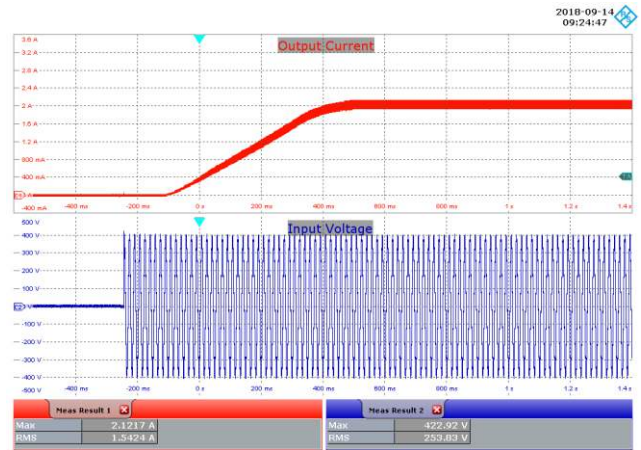

Figure 54 – 277 VAC, 48 V LED, Output Rise.
Upper: I_{OUT}, 400 mA / div.
Lower: V_{IN}, 100 V / div., 200 ms / div.

17.3 Start-up Profile at 36 V LED Load

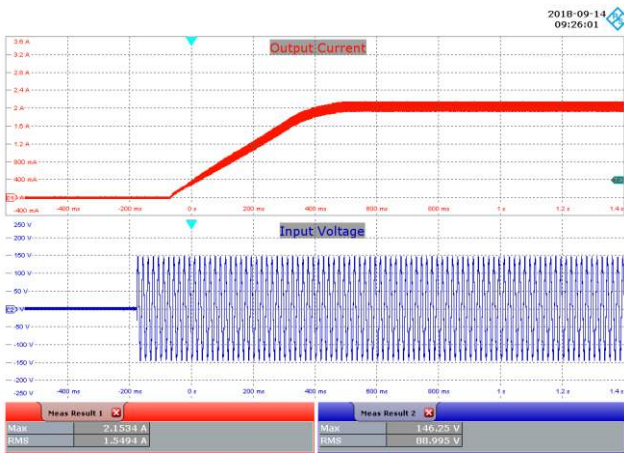

Figure 55 – 100 VAC, 36 V LED, Output Rise.
Upper: I_{OUT} , 400 mA / div.
Lower: V_{IN} , 50 V / div., 200 ms / div.

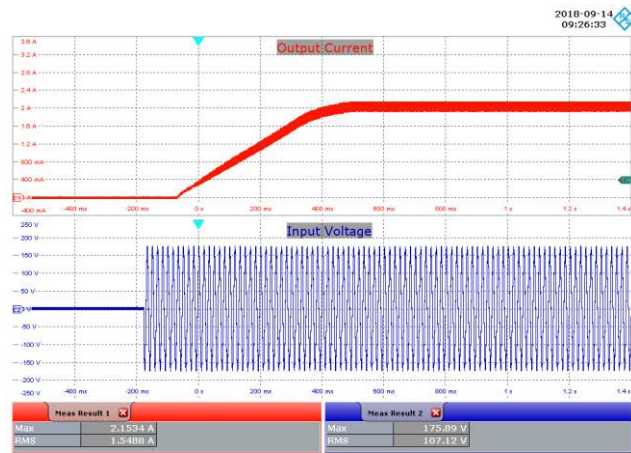

Figure 56 – 120 VAC, 36 V LED, Output Rise.
Upper: I_{OUT} , 400 mA / div.
Lower: V_{IN} , 50 V / div., 200 ms / div.

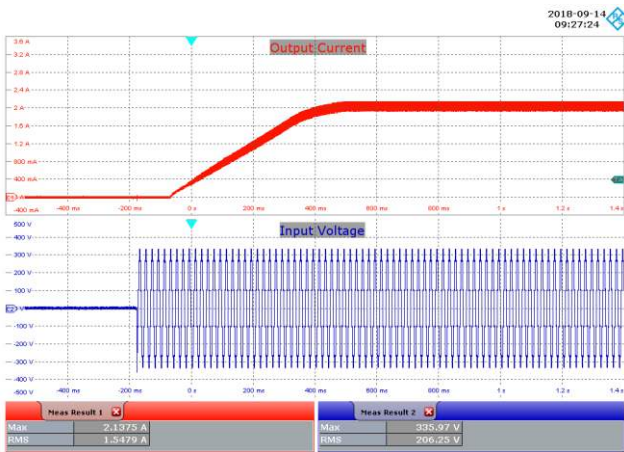

Figure 57 – 230 VAC, 36 V LED, Output Rise.
Upper: I_{OUT} , 400 mA / div.
Lower: V_{IN} , 100 V / div., 200 ms / div.

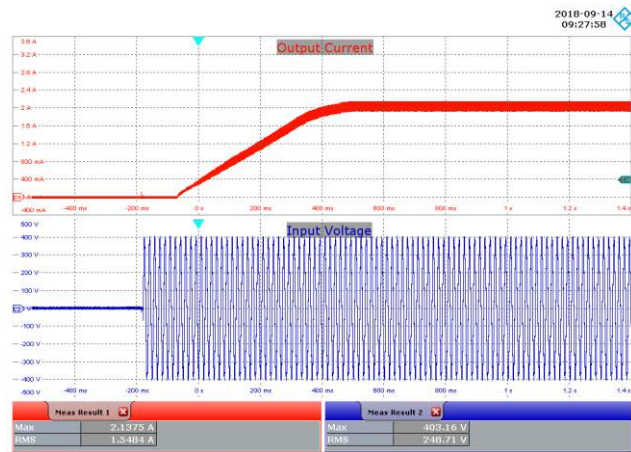

Figure 58 – 277 VAC, 36 V LED, Output Rise.
Upper: I_{OUT} , 400 mA / div.
Lower: V_{IN} , 100 V / div., 200 ms / div.

17.4 Output Current Fall at 48 V LED Load

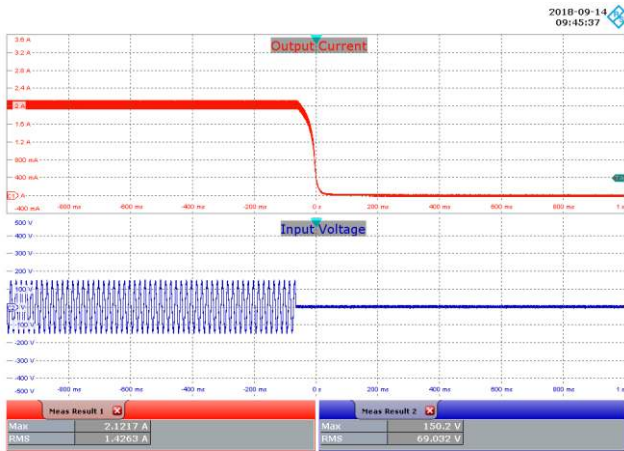

Figure 59 – 100 VAC, 48 V LED, Output Fall.
Upper: I_{OUT} , 400 mA / div.
Lower: V_{IN} , 100 V / div., 200 ms / div.

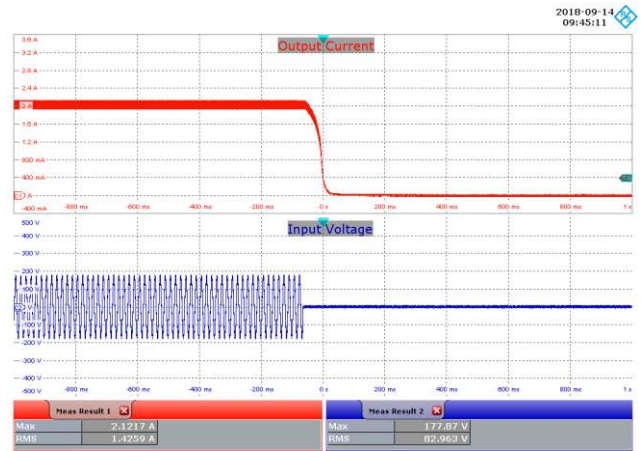

Figure 60 – 120 VAC, 48 V LED, Output Fall.
Upper: I_{OUT} , 400 mA / div.
Lower: V_{IN} , 100 V / div., 200 ms / div.

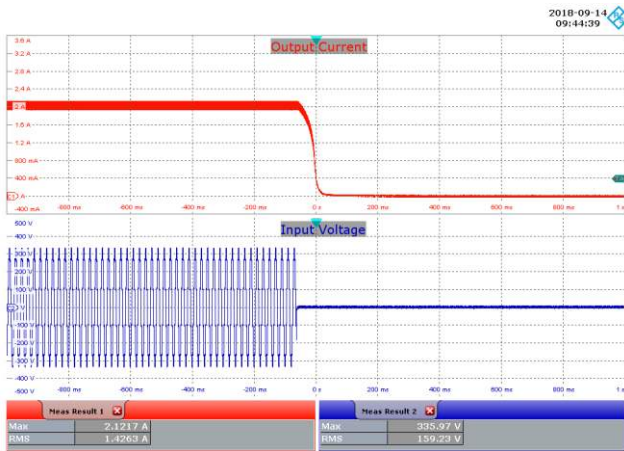

Figure 61 – 230 VAC, 48 V LED, Output Fall.
Upper: I_{OUT} , 400 mA / div.
Lower: V_{IN} , 100 V / div., 200 ms / div.

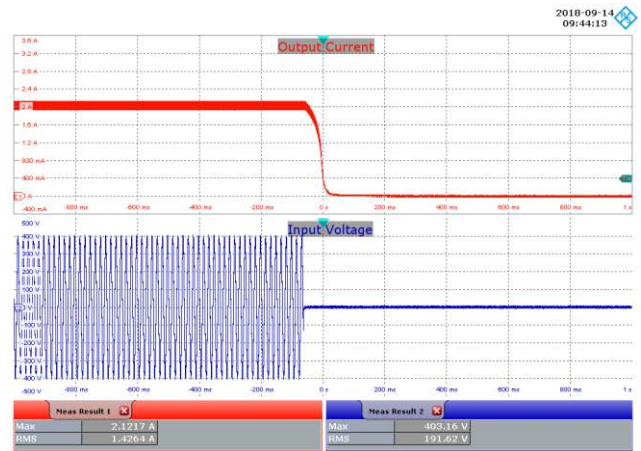

Figure 62 – 277 VAC, 42 V LED, Output Fall.
Upper: I_{OUT} , 400 mA / div.
Lower: V_{IN} , 100 V / div., 200 ms / div.

17.5 Output Current Fall at 36 V LED Load

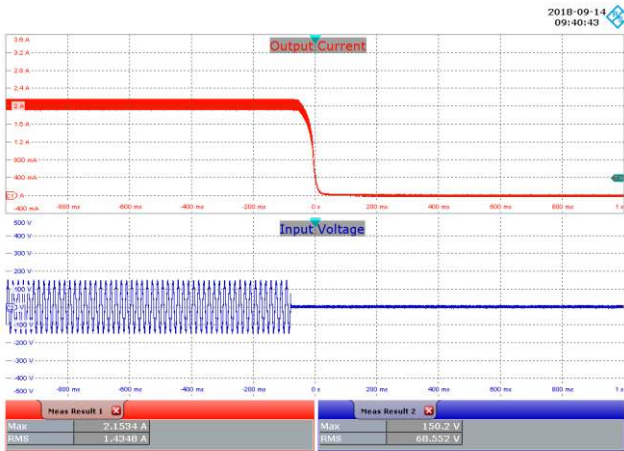

Figure 63 – 100 VAC, 36 V LED, Output Fall.
Upper: I_{OUT} , 400 mA / div.
Lower: V_{IN} , 100 V / div., 200 ms / div.

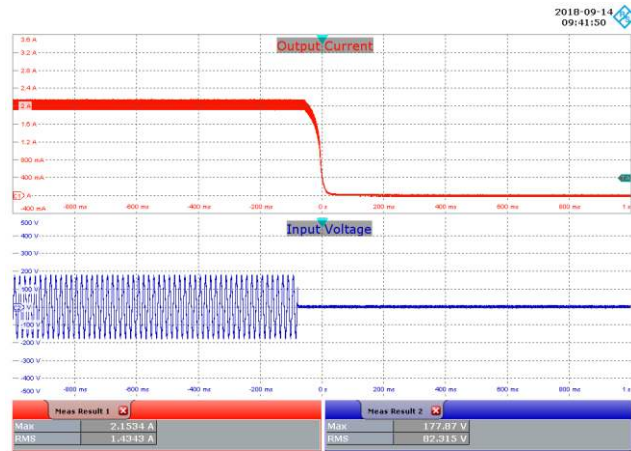

Figure 64 – 120 VAC, 36 V LED, Output Fall.
Upper: I_{OUT} , 400 mA / div.
Lower: V_{IN} , 100 V / div., 200 ms / div.

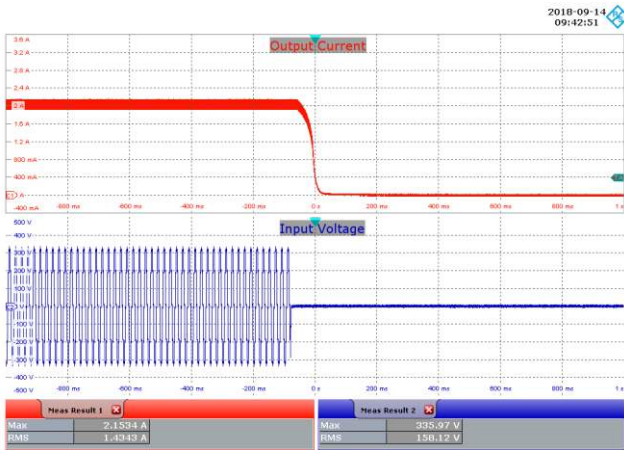

Figure 65 – 230 VAC, 36 V LED, Output Fall.
Upper: I_{OUT} , 400 mA / div.
Lower: V_{IN} , 100 V / div., 200 ms / div.

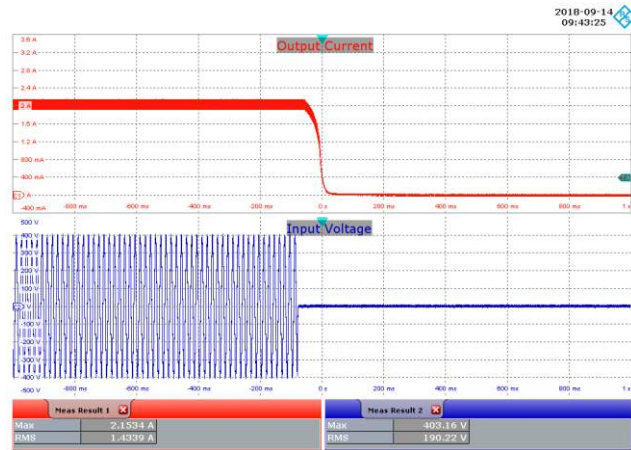

Figure 66 – 277 VAC, 36 V LED, Output Fall.
Upper: I_{OUT} , 400 mA / div.
Lower: V_{IN} , 100 V / div., 200 ms / div.

17.6 PFS7626C (U2) Drain Voltage and Current at Normal Operation

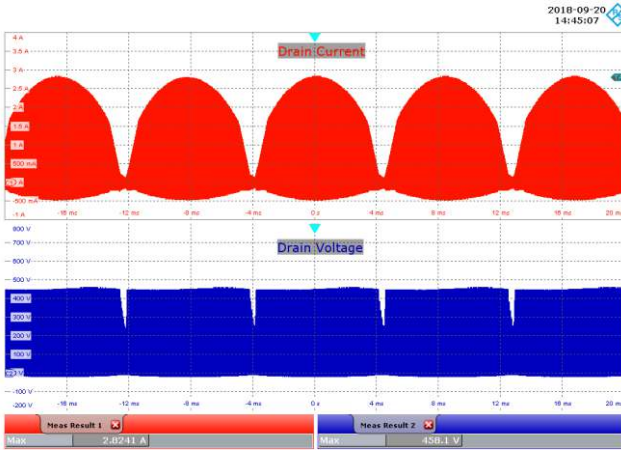

Figure 67 – 100 VAC, 48 V LED Load.
 Upper: I_{DRAIN} , 500 mA / div.
 Lower: V_{DRAIN} , 100 V / div., 4 ms / div.

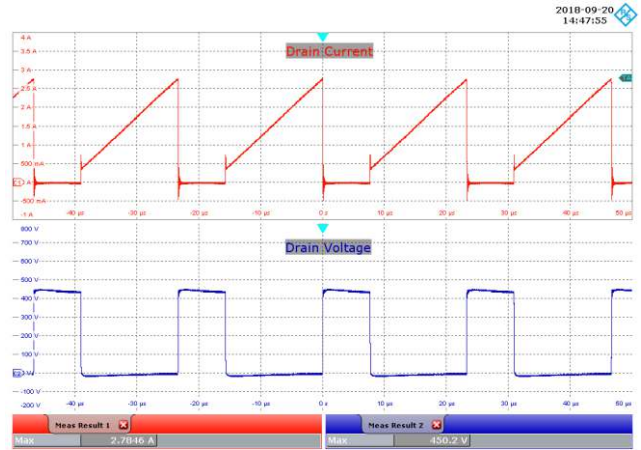

Figure 68 – 100 VAC, 48V LED Load.
 Upper: I_{DRAIN} , 500 mA / div.
 Lower: V_{DRAIN} , 100 V / div., 10 μ s / div.

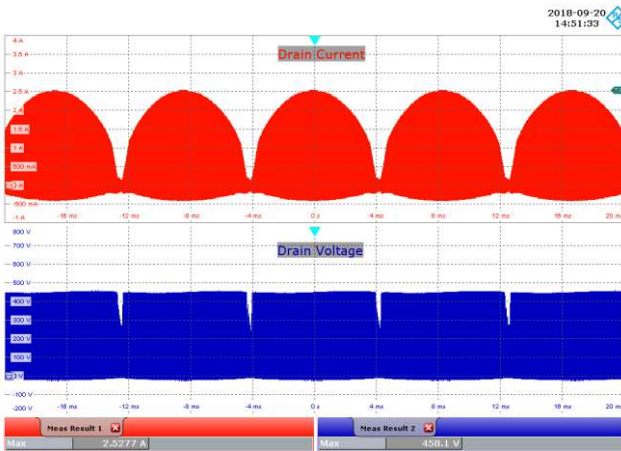

Figure 69 – 120 VAC, 48 V LED Load.
 Upper: I_{DRAIN} , 500 mA / div.
 Lower: V_{DRAIN} , 100 V / div., 4 ms / div.

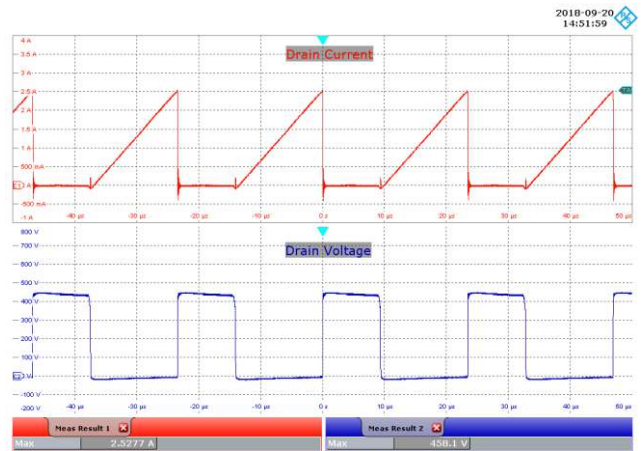

Figure 70 – 120 VAC, 48 V LED Load.
 Upper: I_{DRAIN} , 500 mA / div.
 Lower: V_{DRAIN} , 100 V / div., 10 μ s / div.

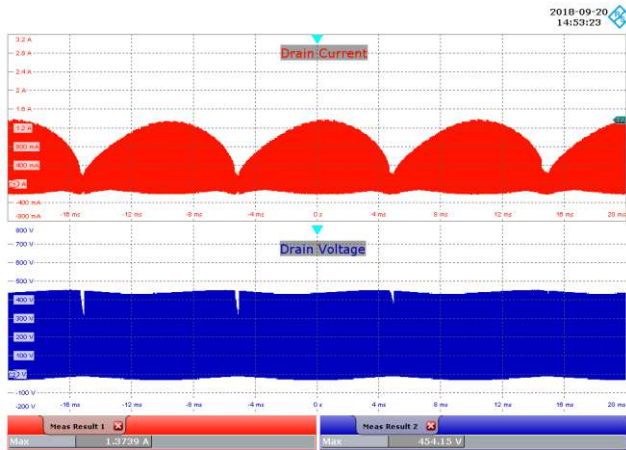

Figure 71 – 230 VAC, 48 V LED Load.
 Upper: I_{DRAIN} , 400 mA / div.
 Lower: V_{DRAIN} , 100 V / div., 4 ms / div.

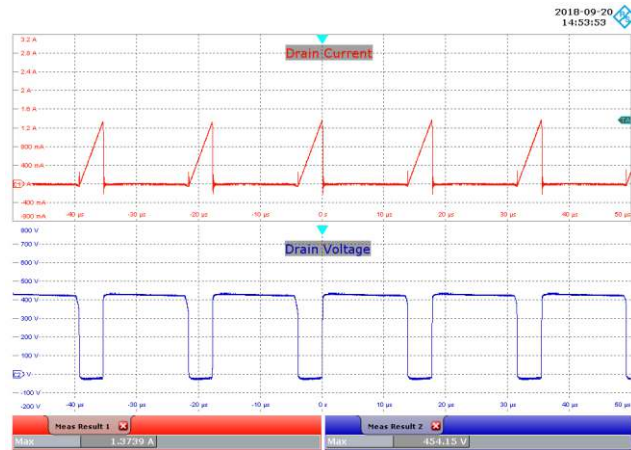

Figure 72 – 230 VAC, 48 V LED Load.
 Upper: I_{DRAIN} , 400 mA / div.
 Lower: V_{DRAIN} , 100 V / div., 10 μ s / div.

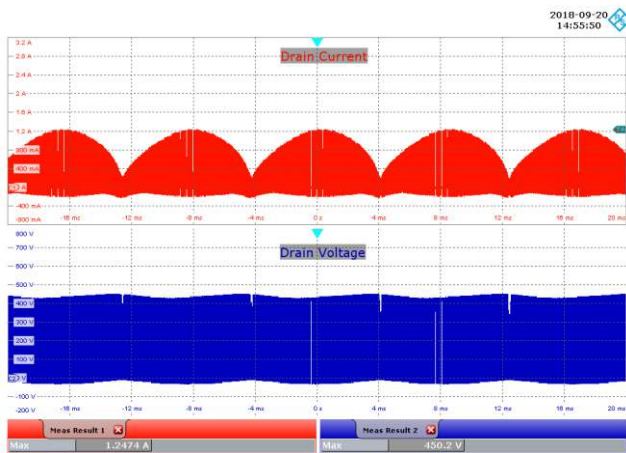

Figure 73 – 277 VAC, 48 V LED Load.
 Upper: I_{DRAIN} , 400 mA / div.
 Lower: V_{DRAIN} , 100 V / div., 4 ms / div.

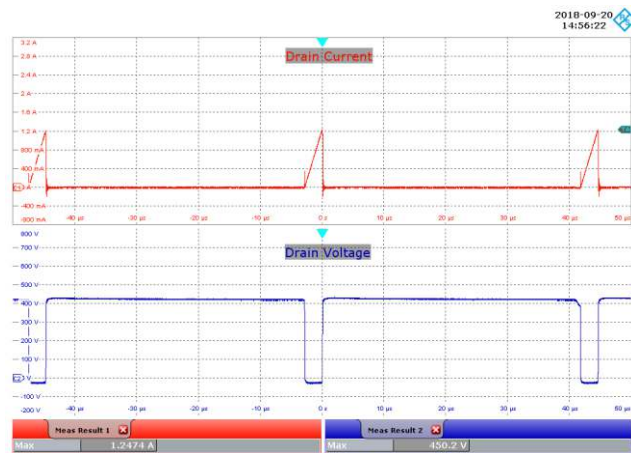

Figure 74 – 277 VAC, 48 V LED Load.
 Upper: I_{DRAIN} , 400 mA / div.
 Lower: V_{DRAIN} , 100 V / div., 10 μ s / div.

17.7 PFS7626C (U2) Drain Voltage and Current at Start-up

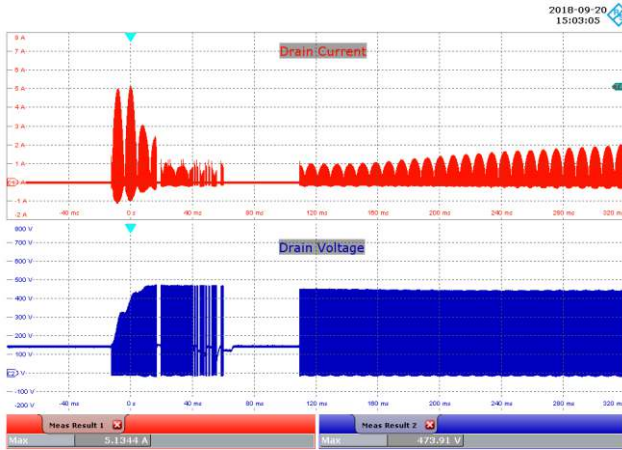

Figure 75 – 100 VAC, 48 V LED Load.
 Upper: I_{DRAIN} , 1 A / div.
 Lower: V_{DRAIN} , 100 V / div., 40 ms / div.

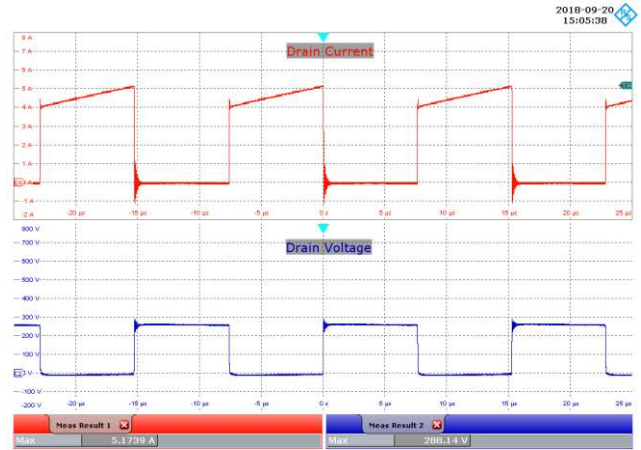

Figure 76 – 100 VAC, 48 V LED Load.
 Upper: I_{DRAIN} , 1 A / div.
 Lower: V_{DRAIN} , 100 V / div., 5 μ s / div.

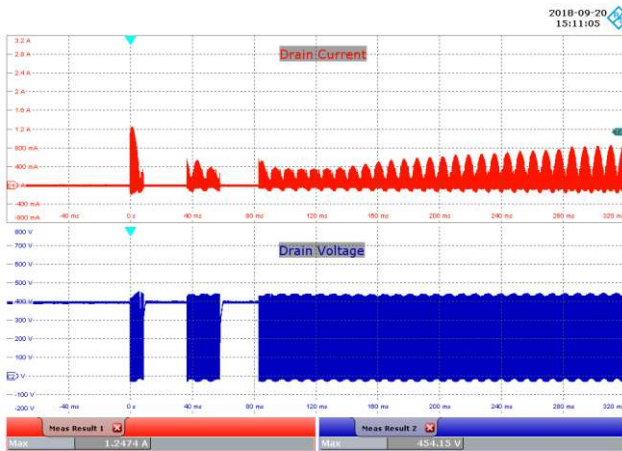

Figure 77 – 277 VAC, 48 V LED Load.
 Upper: I_{DRAIN} , 400 mA / div.
 Lower: V_{DRAIN} , 100 V / div., 40 ms / div.

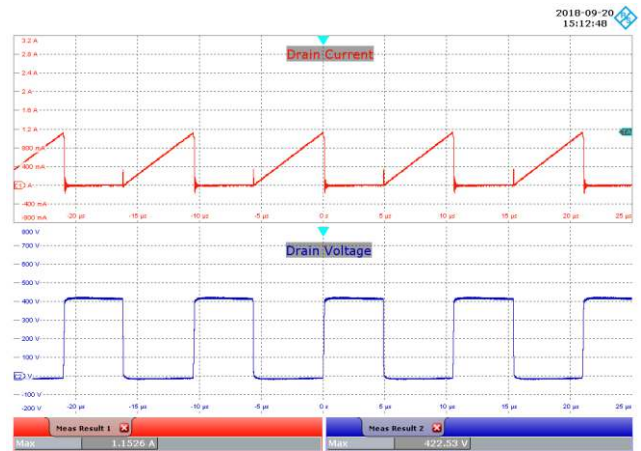

Figure 78 – 277 VAC, 48 V LED Load.
 Upper: I_{DRAIN} , 400 mA / div.
 Lower: V_{DRAIN} , 100 V / div., 5 μ s / div.

17.8 LYTSwitch-6 (U4) Drain Voltage and Current at Normal Operation

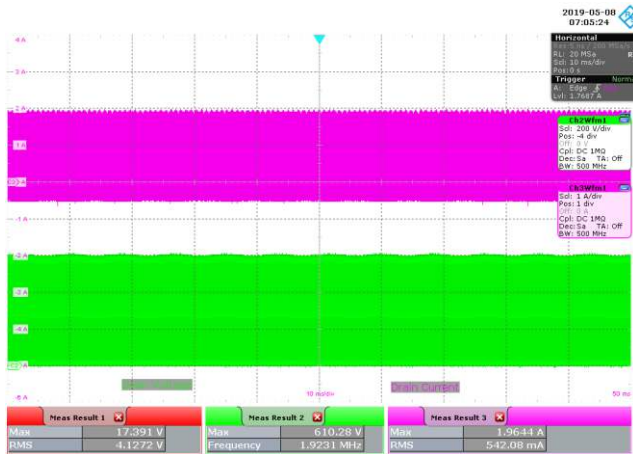

Figure 79 – 100 VAC, 48 V LED Load.
 Upper: I_{DRAIN} , 1 A / div.
 Lower: V_{DRAIN} , 200 V / div., 10 ms / div.

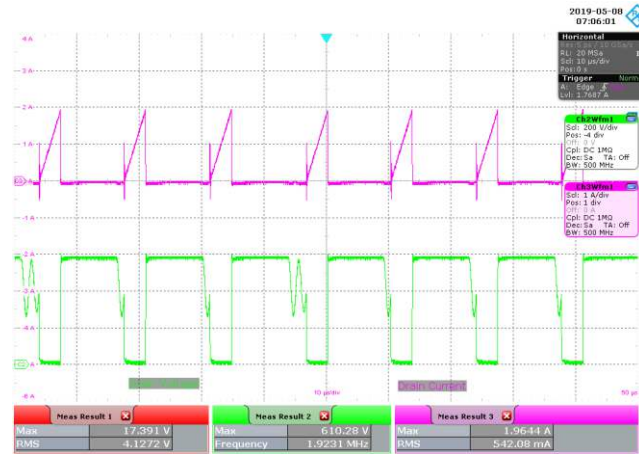

Figure 80 – 100 VAC, 48 V LED Load.
 Upper: I_{DRAIN} , 1 A / div.
 Lower: V_{DRAIN} , 200 V / div., 10 μ s / div.

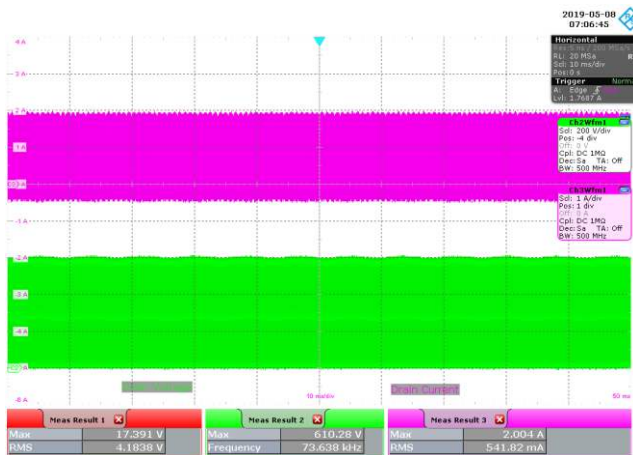

Figure 81 – 120 VAC, 48 V LED Load.
 Upper: I_{DRAIN} , 1 A / div.
 Lower: V_{DRAIN} , 200 V / div., 10 ms / div.

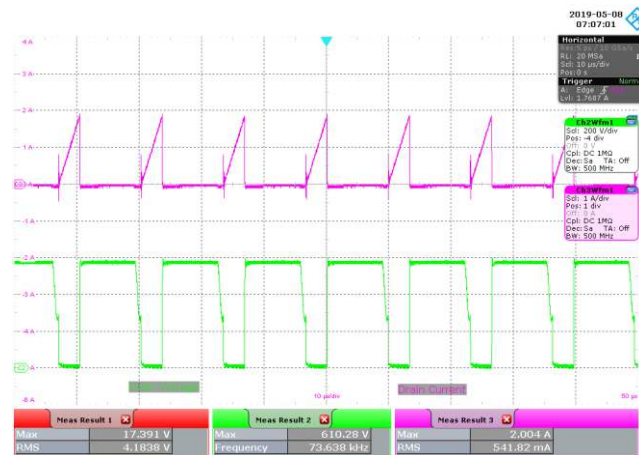

Figure 82 – 120 VAC, 48 V LED Load.
 Upper: I_{DRAIN} , 1 A / div.
 Lower: V_{DRAIN} , 200 V / div., 10 μ s / div.

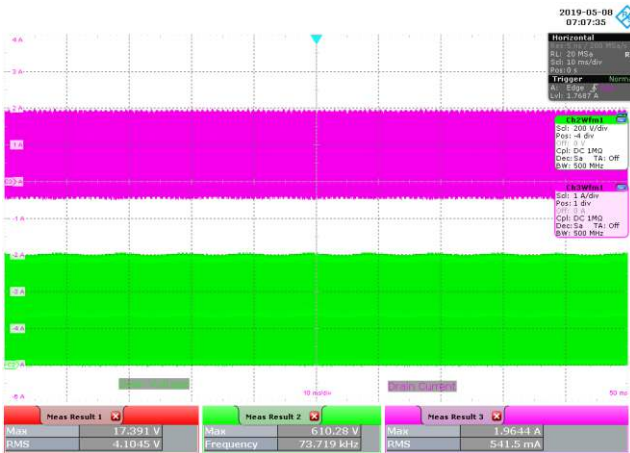

Figure 83 – 230 VAC, 48 V LED Load.
Upper: I_{DRAIN} , 1 A / div.
Lower: V_{DRAIN} , 200 V / div., 10 ms / div.

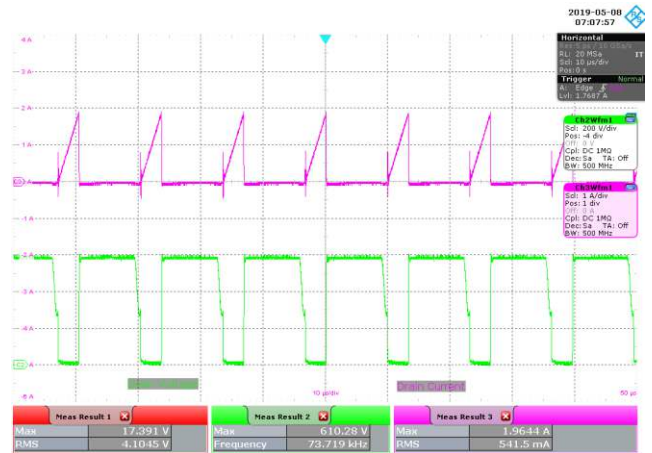

Figure 84 – 230 VAC, 48 V LED Load.
Upper: I_{DRAIN} , 1 A / div.
Lower: V_{DRAIN} , 200 V / div., 10 μs / div.

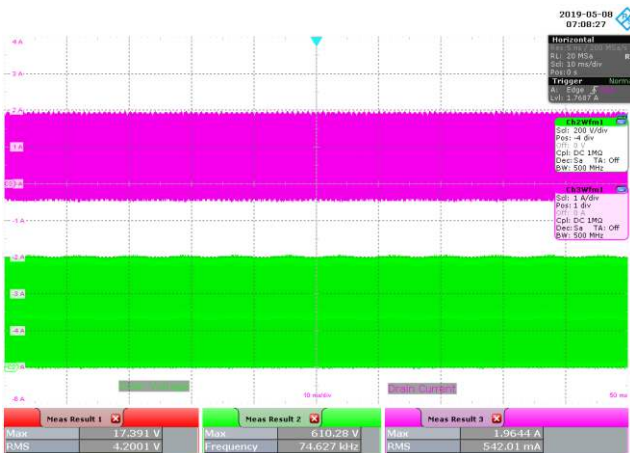

Figure 85 – 277 VAC, 48 V LED Load.
Upper: I_{DRAIN} , 1 A / div.
Lower: V_{DRAIN} , 200 V / div., 10 ms / div.

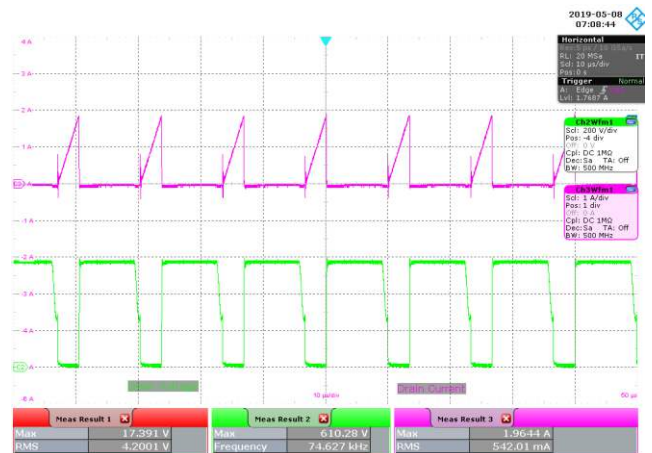

Figure 86 – 277 VAC, 48 V LED Load.
Upper: I_{DRAIN} , 1 A / div.
Lower: V_{DRAIN} , 200 V / div., 10 μs / div.

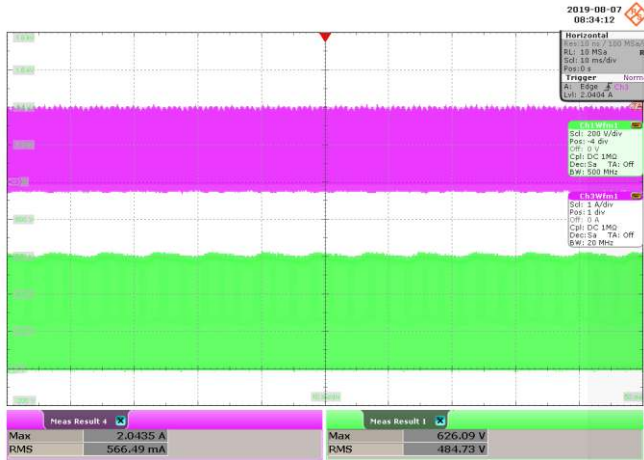

Figure 87 – 305 VAC, 48 V LED Load.
 Upper: I_{DRAIN} , 1 A / div.
 Lower: V_{DRAIN} , 200 V / div., 10 ms / div.

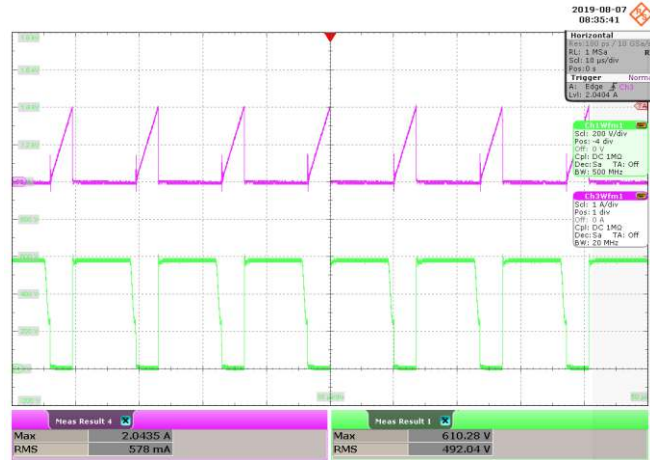

Figure 88 – 305 VAC, 48 V LED Load.
 Upper: I_{DRAIN} , 1 A / div.
 Lower: V_{DRAIN} , 200 V / div., 10 μs / div.

17.9 LYTSwitch-6 (U4) Drain Voltage and Current at Start-up

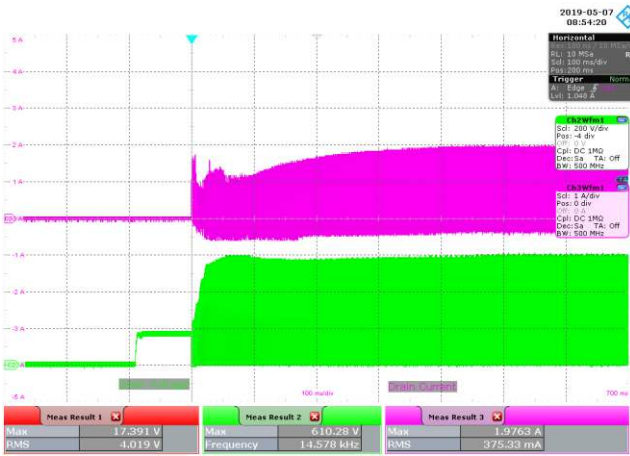

Figure 89 – 100 VAC, 48 V LED Load.
 Upper: I_{DRAIN} , 1 A / div.
 Lower: V_{DRAIN} , 200 V / div., 100 ms / div.

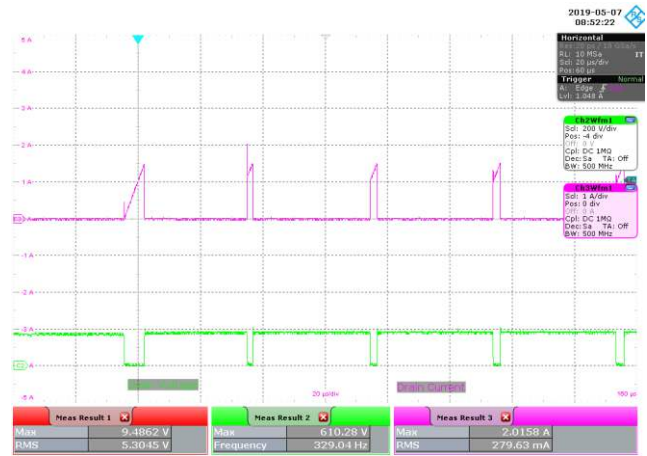

Figure 90 – 100 VAC, 48 V LED Load.
 Upper: I_{DRAIN} , 1 A / div.
 Lower: V_{DRAIN} , 200 V / div., 20 μ s / div.

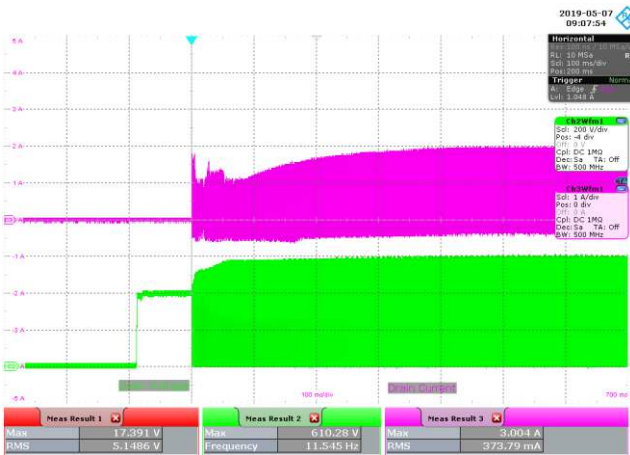

Figure 91 – 277 VAC, 48 V LED Load.
 Upper: I_{DRAIN} , 1 A / div.
 Lower: V_{DRAIN} , 200 V / div., 100 ms / div.

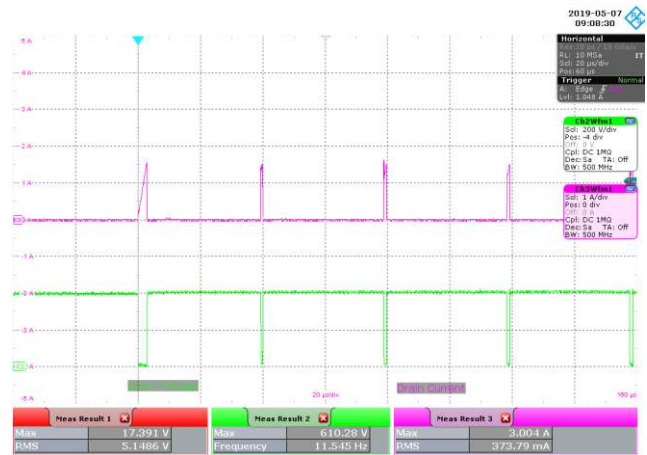

Figure 92 – 277 VAC, 48 V LED Load.
 Upper: I_{DRAIN} , 1 A / div.
 Lower: V_{DRAIN} , 200 V / div., 20 μ s / div.

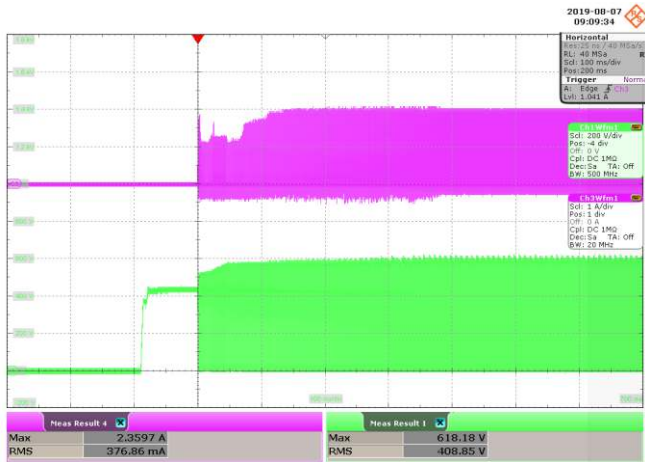

Figure 93 – 305 VAC, 48 V LED Load.
 Upper: I_{DRAIN} , 1 A / div.
 Lower: V_{DRAIN} , 200 V / div., 100 ms / div.

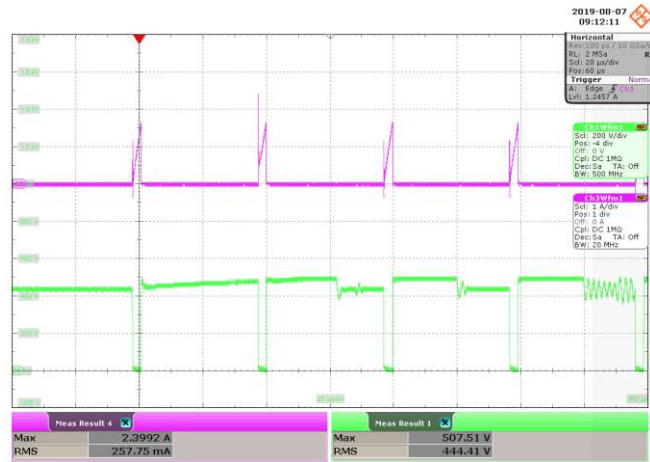

Figure 94 – 305 VAC, 48 V LED Load.
 Upper: I_{DRAIN} , 1 A / div.
 Lower: V_{DRAIN} , 200 V / div., 20 μ s / div.

17.10 LYTSwitch-6 (U4) Drain Voltage and Current during Output Short-Circuit

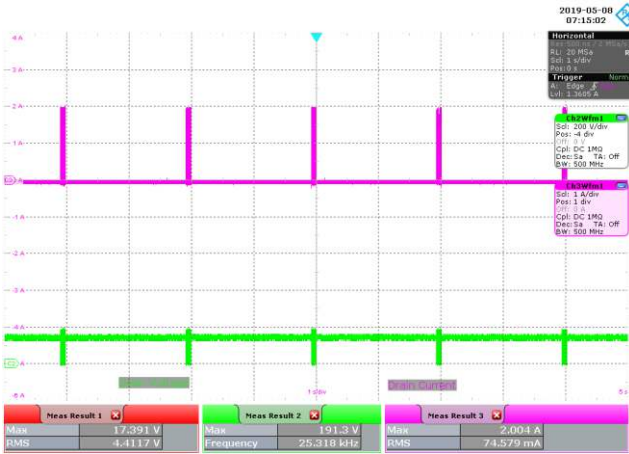

Figure 95 – 100 VAC, Output Shorted.
 Upper: I_{DRAIN} , 1 A / div.
 Lower: V_{DRAIN} , 200 V / div., 1 s / div.

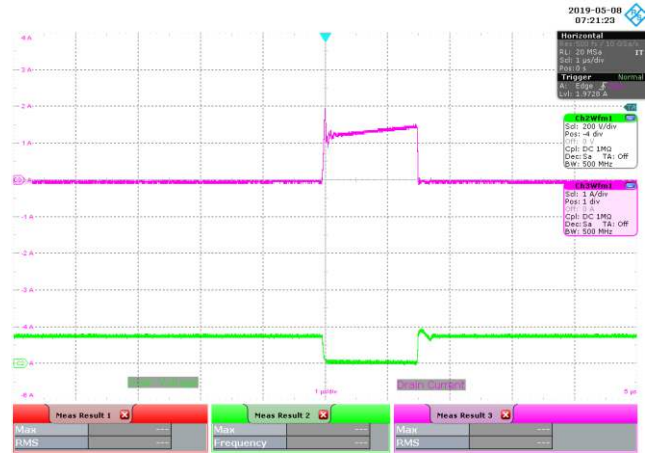

Figure 96 – 100 VAC, Output Shorted.
 Upper: I_{DRAIN} , 1 A / div.
 Lower: V_{DRAIN} , 200 V / div., 1 μs / div.

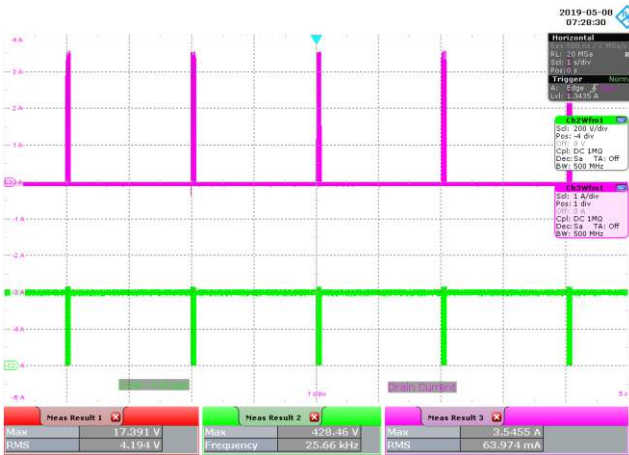

Figure 97 – 277 VAC, Output Shorted.
 Upper: I_{DRAIN} , 1 A / div.
 Lower: V_{DRAIN} , 200 V / div., 1 s / div.

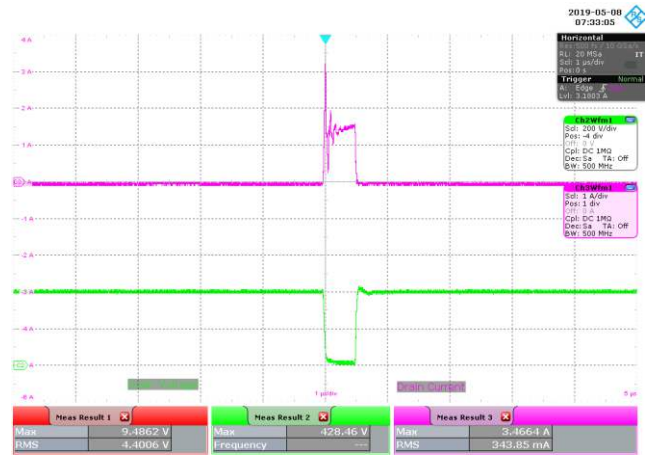

Figure 98 – 277 VAC, Output Shorted.
 Upper: I_{DRAIN} , 1 A / div.
 Lower: V_{DRAIN} , 200 V / div., 1 μs / div.



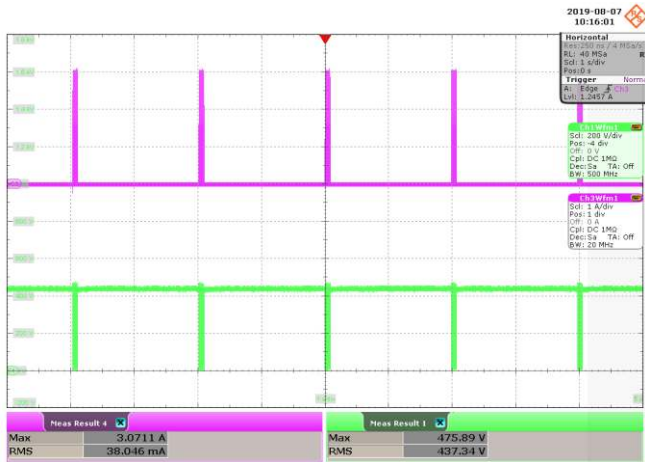

Figure 99 – 305 VAC, Output Shorted.
 Upper: I_{DRAIN} , 1 A / div.
 Lower: V_{DRAIN} , 200 V / div., 1 s / div.

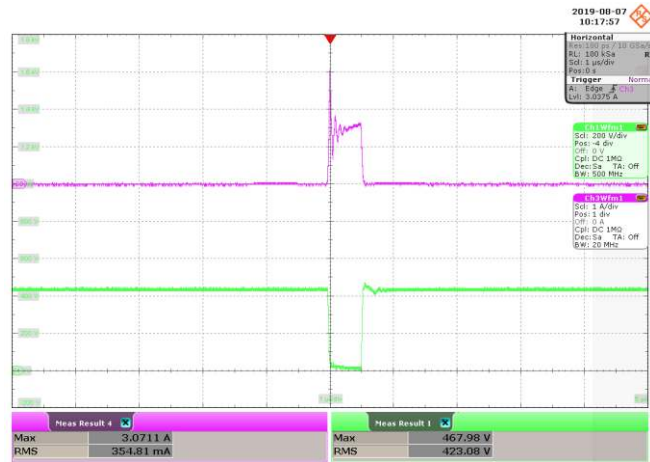

Figure 100 – 305 VAC, Output Shorted.
 Upper: I_{DRAIN} , 1 A / div.
 Lower: V_{DRAIN} , 200 V / div., 1 μ s / div.

17.11 Input Power during Output Short-Circuit

Input		Input Measurement		
VAC (V _{RMS})	Freq (Hz)	V (V _{RMS})	I (mA _{RMS})	P (W)
100.0	60.0	99.98	21.26	0.066
110.0	60.0	110.00	22.33	0.073
115.0	60.0	114.97	22.87	0.077
120.0	60.0	120.02	23.47	0.081
132.0	60.0	132.01	24.87	0.091
180.0	50.0	180.04	27.11	0.131
200.0	50.0	199.99	29.51	0.148
230.0	50.0	230.05	33.28	0.177
265.0	50.0	265.10	37.64	0.212
277.0	60.0	277.09	39.08	0.225

17.12 Output Voltage and Current at Open Output LED Load

Maximum measured no load output voltage is below the rated voltage of the output capacitor

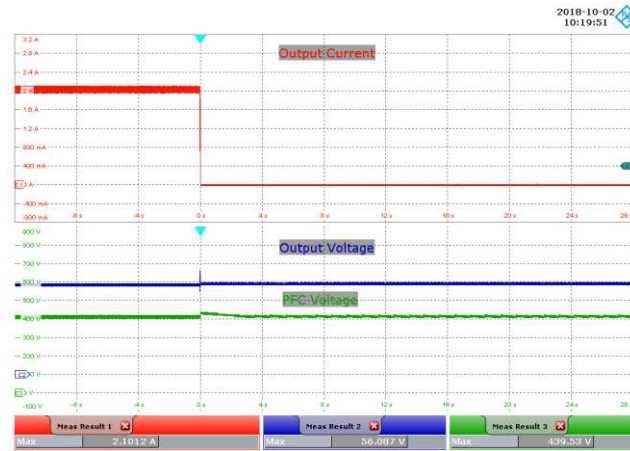
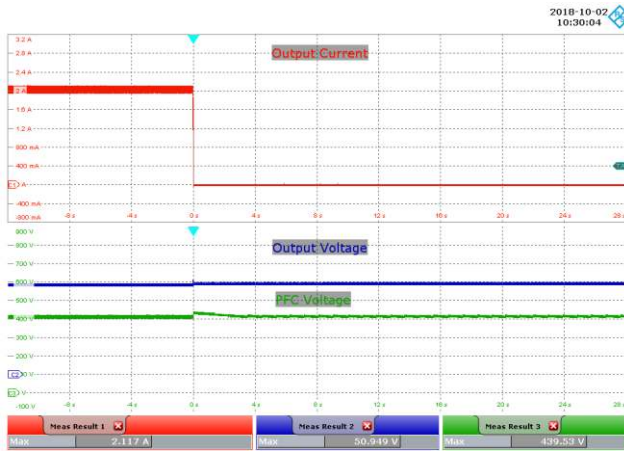

Figure 101 – 100 VAC, 48 V LED Load, Running Open Load.
 I_{OUT} , 400 mA / div.
 V_{OUT} , 10 V / div., 4 s / div.
 PFC V_{OUT} , 100 V / div.

Figure 102 – 277 VAC, 48 V LED Load, Running Open Load.
 I_{OUT} , 400 mA / div.
 V_{OUT} , 10 V / div., 4 s / div.
 PFC V_{OUT} , 100 V / div.

17.13 Output Voltage and Current – Start-up at Open Output Load

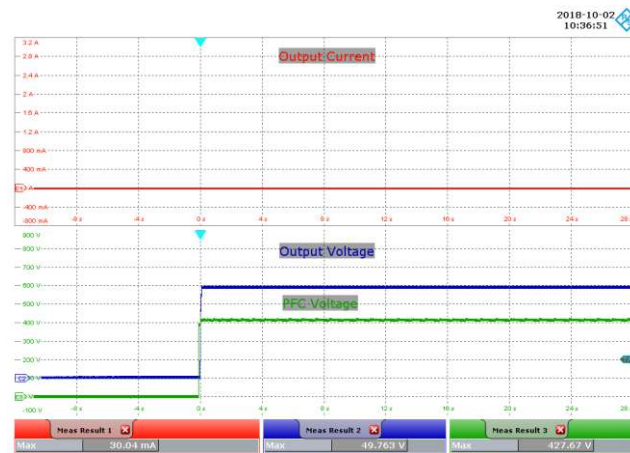
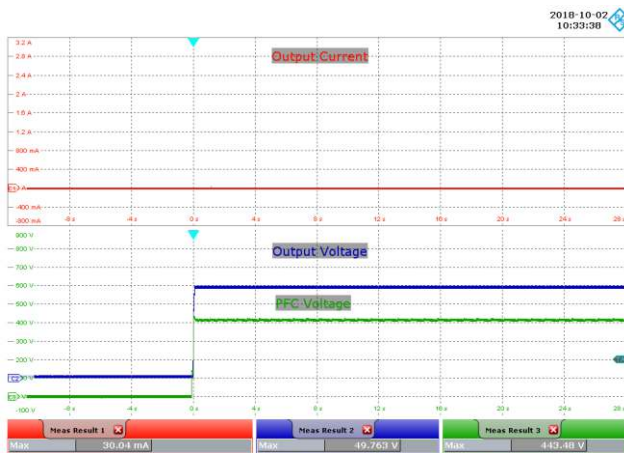

Figure 103 – 100 VAC, Open Load, Open Load Start-up.
 I_{OUT} , 400 mA / div.
 V_{OUT} , 10 V / div., 4 s / div.
 PFC V_{OUT} , 100 V / div.

Figure 104 – 277 VAC, Open Load, Open Load Start-up.
 Upper: I_{OUT} , 400 mA / div.
 Lower: V_{OUT} , 10 V / div., 4 s / div.
 PFC V_{OUT} , 100 V / div.

17.14 Output Ripple Current at Full load

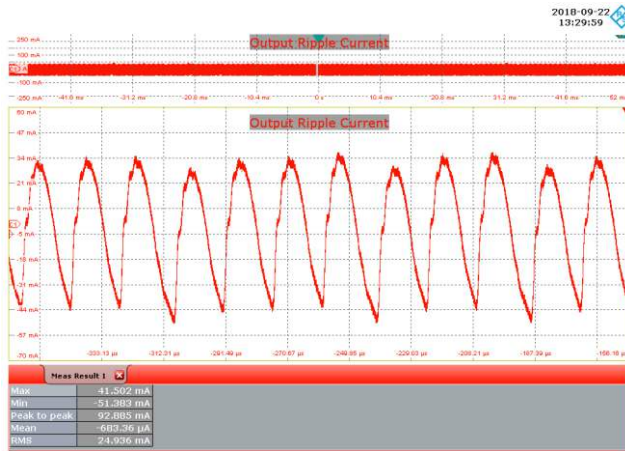

Figure 105 – 100 VAC, 60 Hz, 48 V LED Load.
Upper: I_{OUT} , 50 mA / div., 10.4 ms / div.

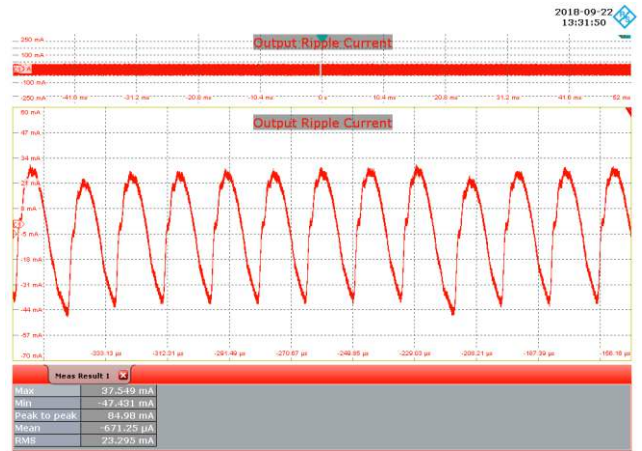

Figure 106 – 120 VAC, 60 Hz, 48 V LED Load.
Upper: I_{OUT} , 50 mA / div., 10.4 ms / div.

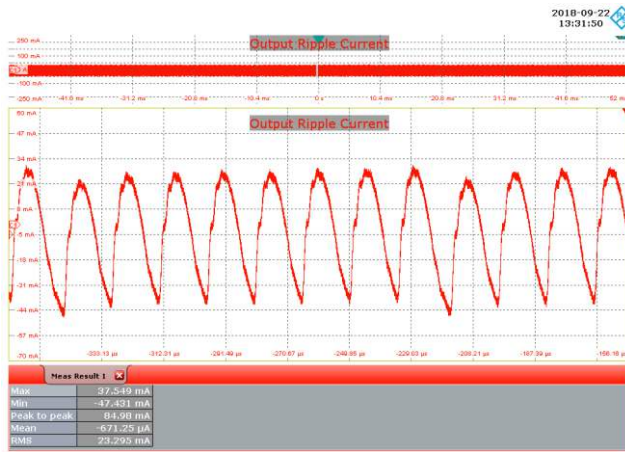

Figure 107 – 230 VAC, 50 Hz, 48 V LED Load.
Upper: I_{OUT} , 50 mA / div., 10.4 ms / div.

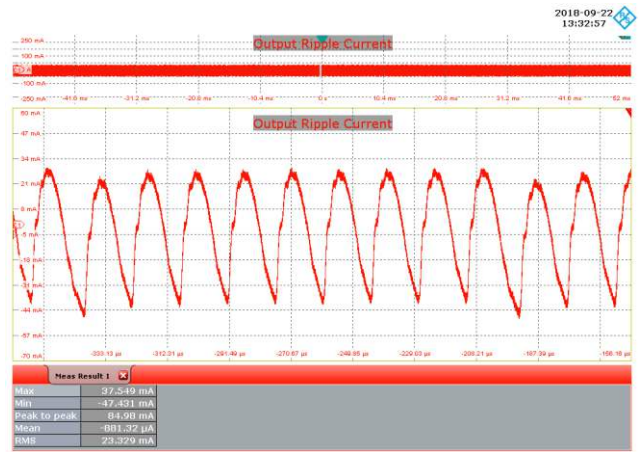

Figure 108 – 277 VAC, 50 Hz, 48 V LED Load.
Upper: I_{OUT} , 50 mA / div., 10.4 ms / div.

V_{IN} (VAC)	I_{PK-PK} (mA)	I_{MEAN} (mA)	% Ripple		% Flicker	
			$100 \times (I_{RP-P}) / (I_{OUT})$		$100 \times (I_{RP-P}) / (2 \times I_{OUT})$	
100	92.89	2080	4.47		2.23	
120	84.98		4.09		2.04	
230	88.93		4.28		2.14	
277	84.98		4.09		2.04	

17.15 Output Ripple Current at 36 V LED Load

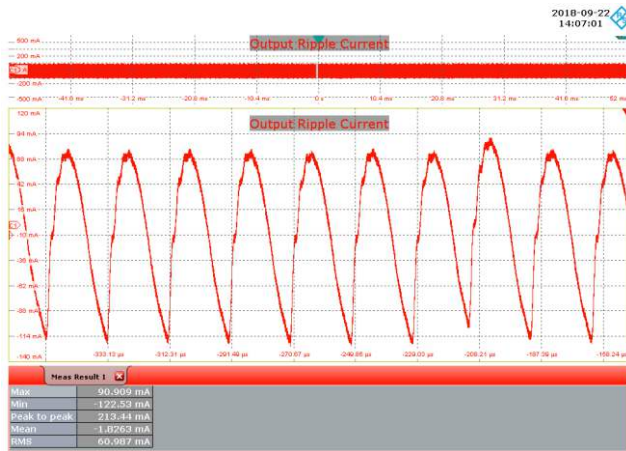

Figure 109 – 100 VAC, 60 Hz, 36 V LED Load.
Upper: I_{OUT} , 50 mA / div., 10 ms / div.

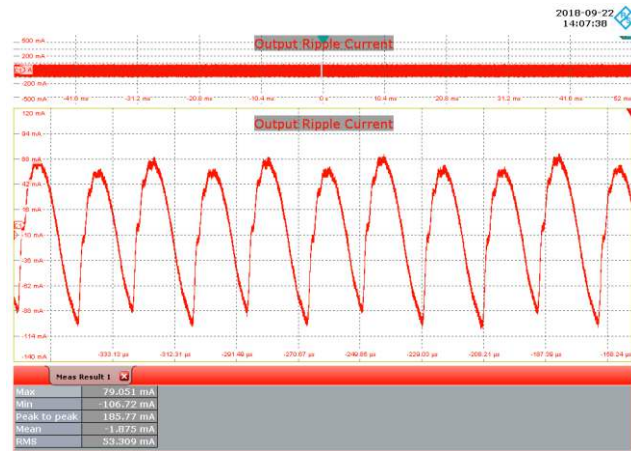

Figure 110 – 120 VAC, 20 Hz, 36 V LED Load.
Upper: I_{OUT} , 50 mA / div., 10 ms / div.

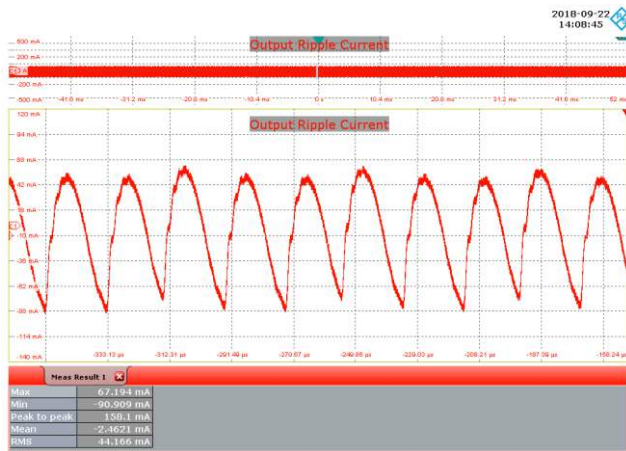

Figure 111 – 230 VAC, 50 Hz, 30 V LED Load.
Upper: I_{OUT} , 50 mA / div., 10 ms / div.

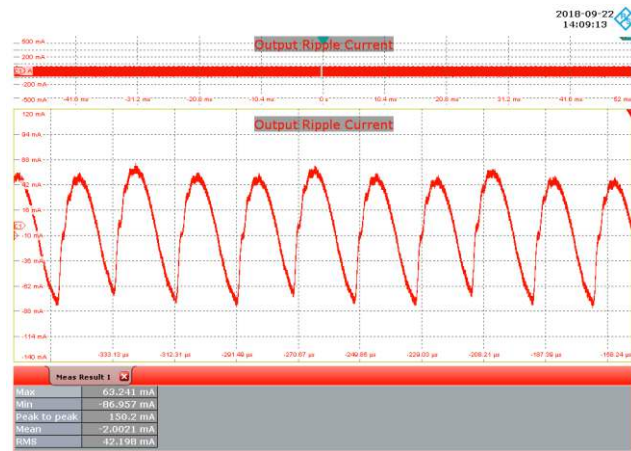

Figure 112 – 277 VAC, 60 Hz, 36 V LED Load.
Upper: I_{OUT} , 50 mA / div., 10 ms / div.

V_{IN} (VAC)	I_{PK-PK} (mA)	I_{MEAN} (mA)	% Ripple	% Flicker
			$100 \times (I_{RP-P}) / (I_{OUT})$	$100 \times (I_{RP-P}) / (2 \times I_{OUT})$
100	213.44	2080	10.26	5.13
120	185.77		8.93	4.47
230	158.1		7.60	3.80
277	150.2		7.22	3.61

18 AC Cycling Test at 48 V LED Load

No output current overshoot or undershoot was observed during on/off cycling.

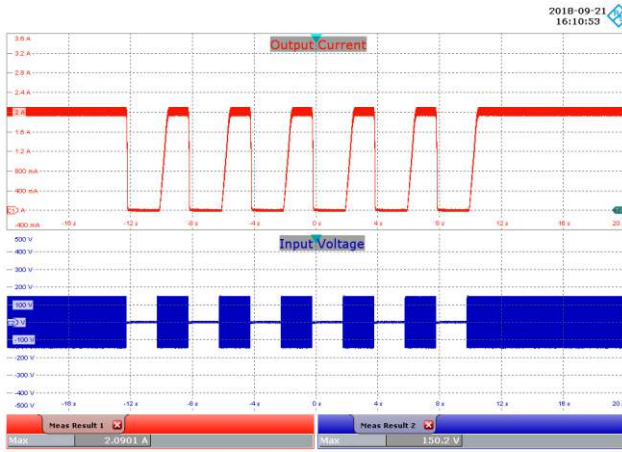

Figure 113 – 100 VAC, 48 V LED Load.
 2 s On – 2 s Off.
 Upper: I_{OUT} , 400 mA / div.
 Lower: V_{IN} , 100 V / div., 4 s / div.

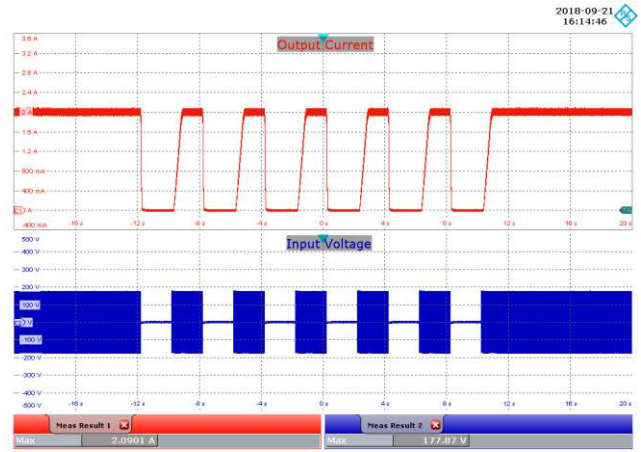

Figure 114 – 120 VAC, 48 V LED Load.
 2 s On – 2 s Off.
 Upper: I_{OUT} , 400 mA / div.
 Lower: V_{IN} , 100 V / div., 4 s / div.

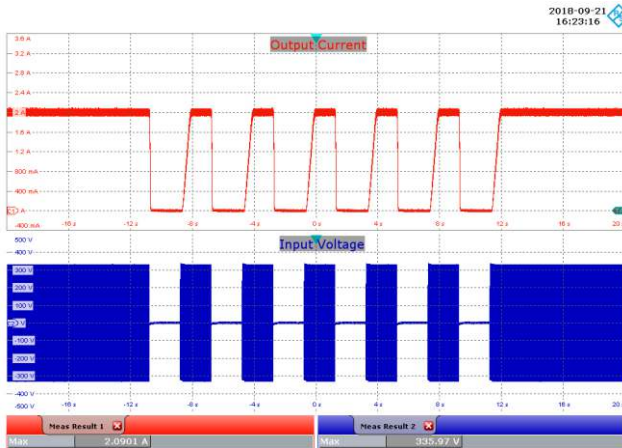

Figure 115 – 230 VAC, 48 V LED Load.
 2 s On – 2 s Off.
 Upper: I_{OUT} , 400 mA / div.
 Lower: V_{IN} , 100 V / div., 4 s / div.

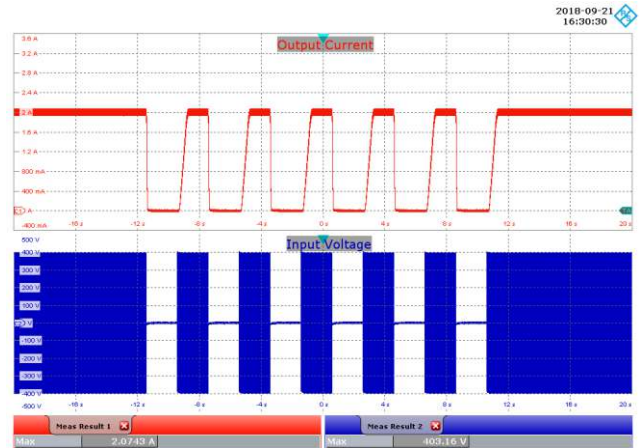

Figure 116 – 277 VAC, 48 V LED Load.
 2 s On – 2 s Off.
 Upper: I_{OUT} , 400 mA / div.
 Lower: V_{IN} , 100 V / div., 4 s / div.



19 AC Cycling Test at 36 V LED Load

No output current overshoot or undershoot was observed during on/off cycling.

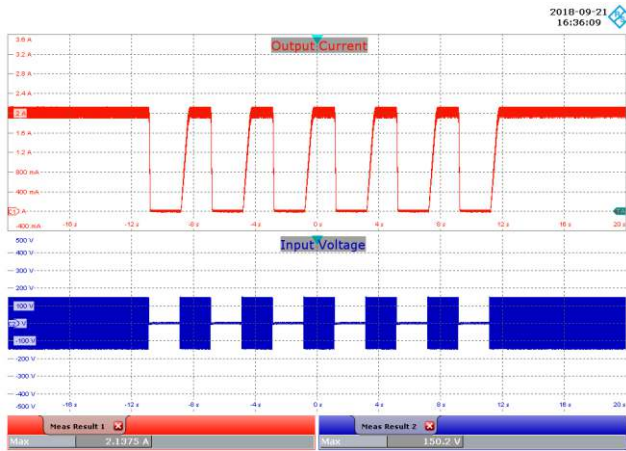

Figure 117 – 100 VAC, 36 V LED Load.
 2 s On – 2 s Off.
 Upper: I_{OUT} , 400 mA / div.
 Lower: V_{IN} , 100 V / div., 4 s / div.

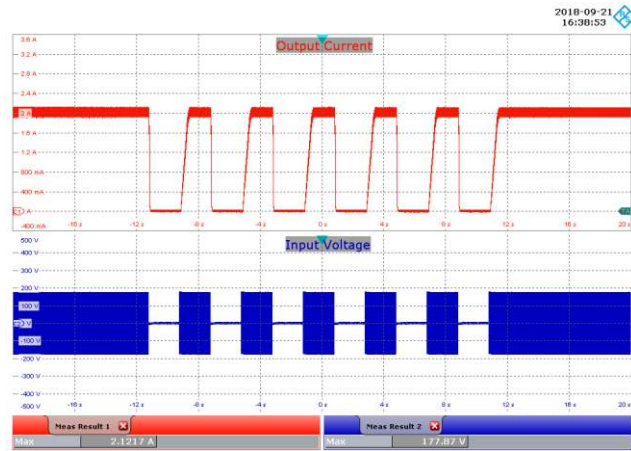

Figure 118 – 120 VAC, 36 V LED Load.
 2 s On – 2 s Off.
 Upper: I_{OUT} , 400 mA / div.
 Lower: V_{IN} , 100 V / div., 4 s / div.

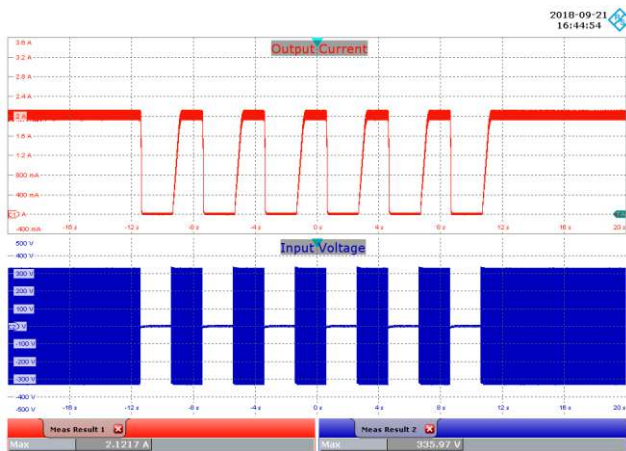

Figure 119 – 230 VAC, 36 V LED Load.
 2 s On – 2 s Off.
 Upper: I_{OUT} , 400 mA / div.
 Lower: V_{IN} , 100 V / div., 4 s / div.

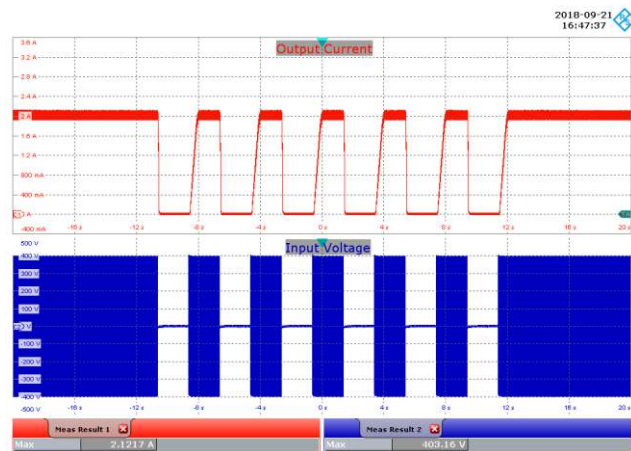

Figure 120 – 277 VAC, 36 V LED Load.
 2 s On – 2 s Off.
 Upper: I_{OUT} , 400 mA / div.
 Lower: V_{IN} , 100 V / div., 4 s / div.

20 Conducted EMI

20.1 Test Set-up

LED metal heat sink is connected to ground. Unit with input ground wire connection is placed on top of LED metal heat sink. See below set-up picture.

20.2 Equipment and Load Used

1. Rohde and Schwarz ENV216 two line V-network.
2. Rohde and Schwarz ESRP EMI test receiver.
3. Hioki 3322 power hitester.
4. Chroma measurement test fixture.
5. 48 V LED load with input voltage set at 120 VAC and 230 VAC.

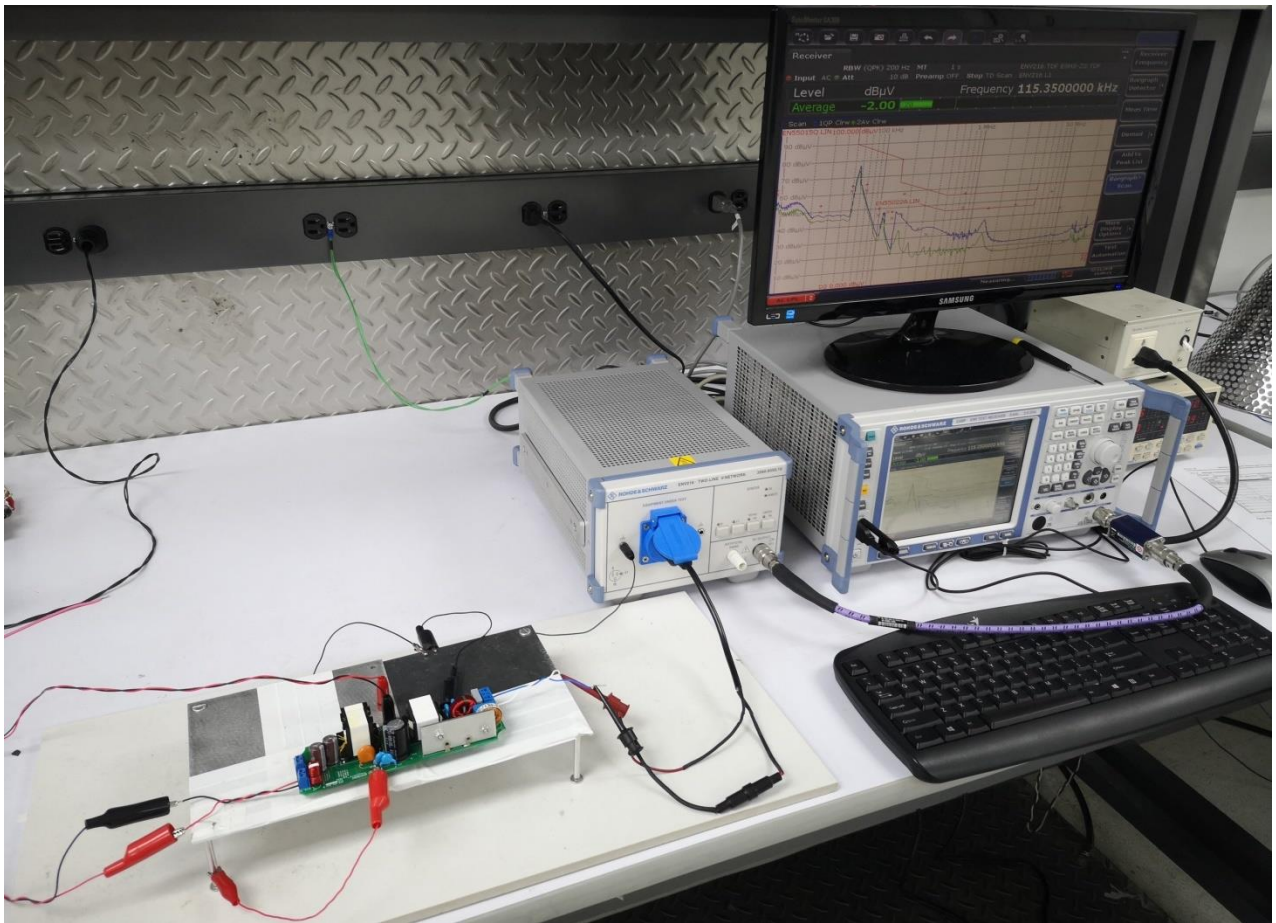

Figure 121 – Conducted EMI Test Set-up.

20.2.1 EMI Test Results



Figure 122 – Conducted EMI QP Scan at 48 V LED Load, 120 VAC, 60 Hz, and EN55015 B Limits.

Trace/Detector	Frequency	Level dBµV	DeltaLimit
2 Average	206.2500 kHz	45.75 L1	-7.60 dB
1 Quasi Peak	150.0000 kHz	57.26 L1	-8.74 dB
1 Quasi Peak	56.4500 kHz	77.64 N	-11.26 dB
2 Average	343.5000 kHz	37.83 L1	-11.29 dB
2 Average	411.0000 kHz	35.01 L1	-12.62 dB
2 Average	23.6495 MHz	30.95 L1	-19.05 dB
1 Quasi Peak	23.6585 MHz	38.10 L1	-21.90 dB
1 Quasi Peak	138.0000 kHz	56.05 N	-24.71 dB
2 Average	26.6038 MHz	25.24 L1	-24.76 dB
1 Quasi Peak	26.6015 MHz	34.53 L1	-25.47 dB
1 Quasi Peak	136.8000 kHz	55.24 N	-25.60 dB
1 Quasi Peak	133.1500 kHz	53.77 N	-27.31 dB
1 Quasi Peak	134.4500 kHz	52.21 N	-28.79 dB
1 Quasi Peak	29.5738 MHz	31.03 L1	-28.97 dB

Figure 123 – Conducted EMI Data at 120 VAC, 48 V LED Load.

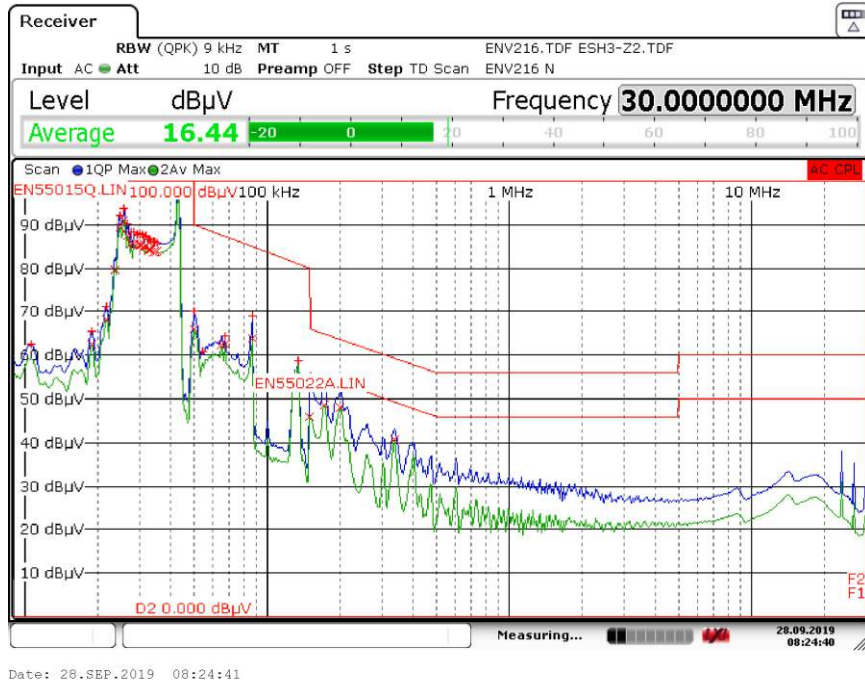

Figure 124 – Conducted EMI QP Scan at 48 V LED Load, 230 VAC, 60 Hz, and EN55015 B Limits.

Trace/Detector	Frequency	Level dBµV	DeltaLimit
2 Average	199.5000 kHz	48.21	-5.42 dB
2 Average	172.5000 kHz	48.58	-6.26 dB
1 Quasi Peak	43.3000 kHz	101.43 N	-8.57 dB
2 Average	334.5000 kHz	40.75	-8.59 dB
2 Average	150.0000 kHz	45.95	-10.05 dB
1 Quasi Peak	86.7000 kHz	69.11 N	-15.88 dB
1 Quasi Peak	25.7500 kHz	93.79 N	-16.21 dB
1 Quasi Peak	24.6500 kHz	92.15 N	-17.85 dB
1 Quasi Peak	26.6500 kHz	90.25 N	-19.75 dB
1 Quasi Peak	50.2000 kHz	70.00 N	-19.96 dB
1 Quasi Peak	28.2500 kHz	88.25 N	-21.75 dB
1 Quasi Peak	27.5000 kHz	88.23 N	-21.77 dB
1 Quasi Peak	29.7000 kHz	87.91 N	-22.09 dB
1 Quasi Peak	29.0000 kHz	87.85 N	-22.15 dB

Figure 125 – Conducted EMI Data at 230 VAC, 48 V LED Load.



21 Line Surge

The unit was subjected to ± 2500 V, 100 kHz ring wave and ± 1000 V differential surge with 10 strikes at each condition. A test failure was defined as a non-recoverable interruption of output requiring repair or recycling of input voltage.

21.1 Differential Surge Test Results

Surge Level (V)	Input Voltage (VAC)	Injection Location	Injection Phase (°)	Test Result (Pass/Fail)
+1000	115	L to N	0	Pass
-1000	115	L to N	0	Pass
+1000	115	L to N	90	Pass
-1000	115	L to N	90	Pass
+1000	115	L to N	270	Pass
-1000	115	L to N	270	Pass
+1000	230	L to N	0	Pass
-1000	230	L to N	0	Pass
+1000	230	L to N	90	Pass
-1000	230	L to N	90	Pass
+1000	230	L to N	270	Pass
-1000	230	L to N	270	Pass

21.2 Ring Wave Surge Test Results

Surge Level (V)	Input Voltage (VAC)	Injection Location	Injection Phase (°)	Test Result (Pass/Fail)
+2500	115	L to N	0	Pass
-2500	115	L to N	0	Pass
+2500	115	L to N	90	Pass
-2500	115	L to N	90	Pass
+2500	115	L to N	270	Pass
-2500	115	L to N	270	Pass
+2500	230	L to N	0	Pass
-2500	230	L to N	0	Pass
+2500	230	L to N	90	Pass
-2500	230	L to N	90	Pass
+2500	230	L to N	270	Pass
-2500	230	L to N	270	Pass

21.3 1 kV Differential Surge Test at 115 VAC

The Drain voltage of PFC driver PFS7626C was measured during 1 kV differential surge test at 115 VAC line input.

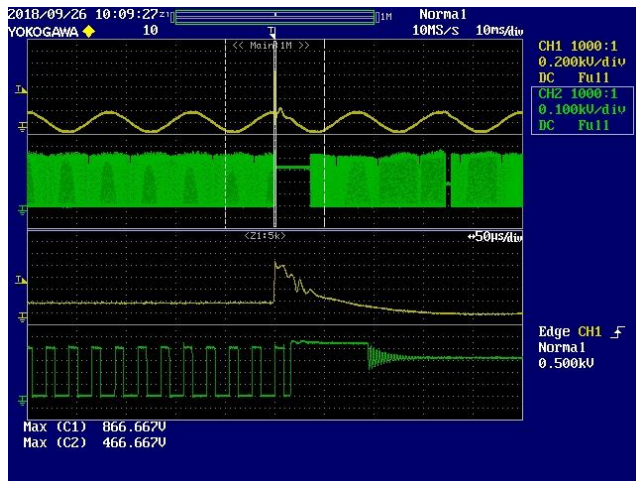

Figure 126 – (+)1 kV Differential Surge, 90° Phase Angle.
 Lower: V_{DRAIN} , 100 V / div., 10 ms / div.
 Peak V_{DRAIN} : 466.67 V.

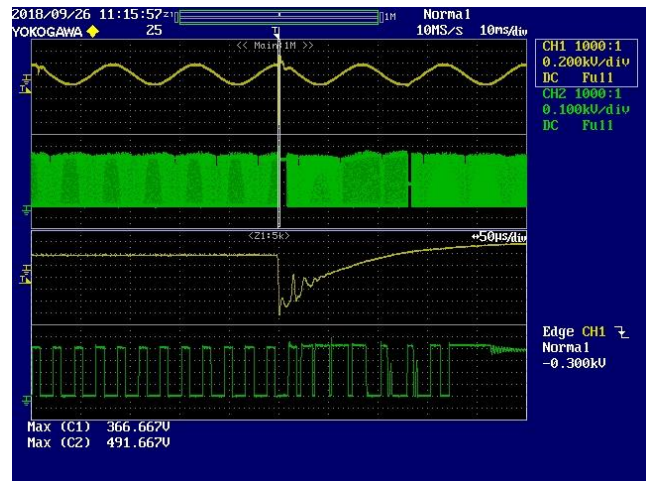

Figure 127 – (-)1 kV Differential Surge, 90° Phase Angle.
 Lower: V_{DRAIN} , 100 V / div., 10 ms / div.
 Peak V_{DRAIN} : 491.67 V.

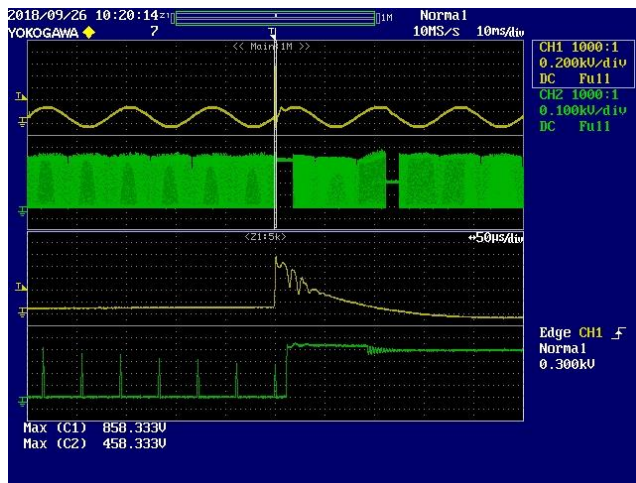

Figure 128 – (+)1 kV Differential Surge, 0° Phase Angle.
 Lower: V_{DRAIN} , 100 V / div., 10 ms / div.
 Peak V_{DRAIN} : 458.33 V.

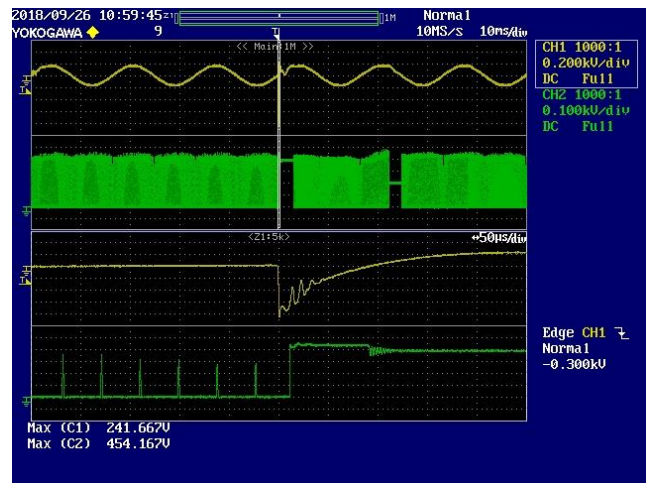

Figure 129 – (-)1 kV Differential Surge, 0° Phase Angle.
 Lower: V_{DRAIN} , 100 V / div., 10 ms / div.
 Peak V_{DRAIN} : 454.17 V.



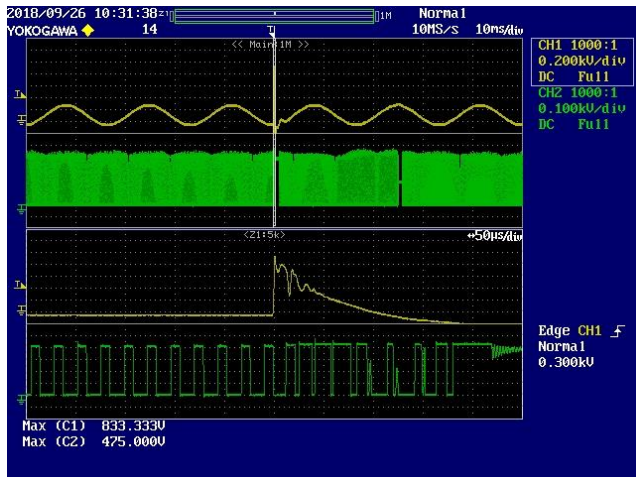

Figure 130 – (+)1 kV Differential Surge, 270° Phase Angle.
 Lower: V_{DRAIN} , 100 V / div., 10 ms / div.
 Peak V_{DRAIN} : 475 V.

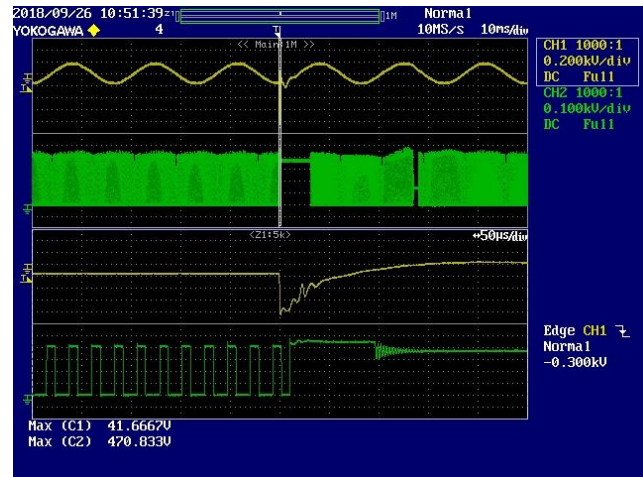

Figure 131 – (-)1 kV Differential Surge, 270° Phase Angle.
 Lower: V_{DRAIN} , 100 V / div., 10 ms / div.
 Peak V_{DRAIN} : 470.83 V.

21.4 1 kV Differential Surge Test at 230 VAC

The Drain voltage of PFC driver PFS7626C was measured during 1 kV differential surge test at 230 VAC line input.

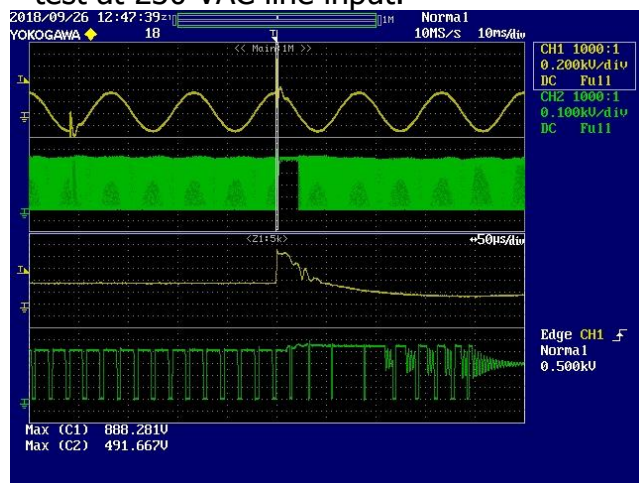

Figure 132 – (+)1 kV Differential Surge, 90° Phase Angle.
 Lower: V_{DRAIN} , 100 V / div., 10 ms / div.
 Peak V_{DRAIN} : 491.67 V.

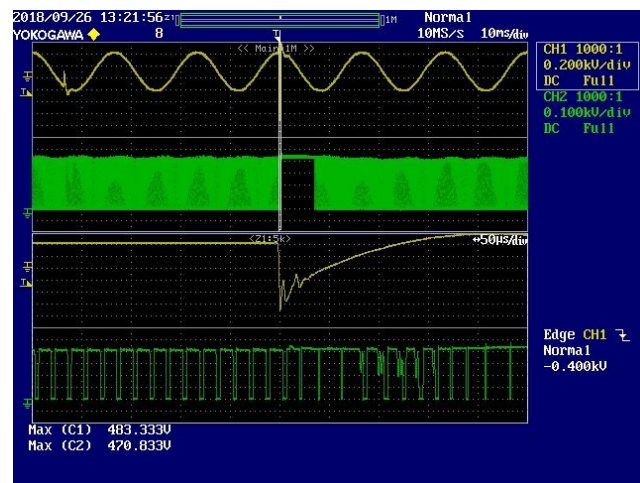

Figure 133 – (-)1 kV Differential Surge, 90° Phase Angle.
 Lower: V_{DRAIN} , 100 V / div., 10 ms / div.
 Peak V_{DRAIN} : 470.83 V.

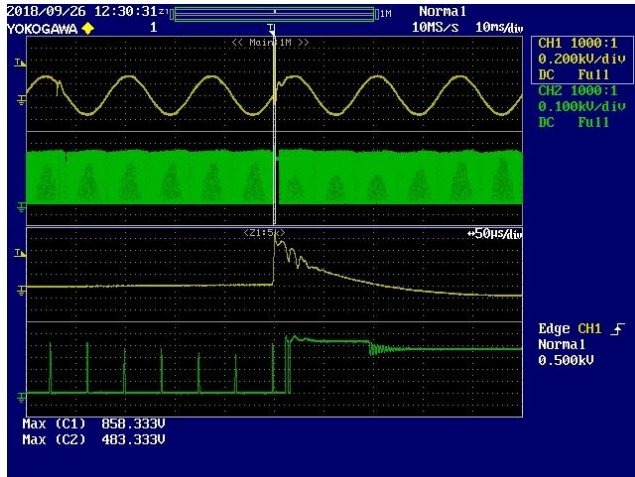

Figure 134 – (+)1 kV Differential Surge, 0° Phase Angle.
 Lower: V_{DRAIN} , 100 V / div., 10 ms / div.
 Peak V_{DRAIN} : 483.33 V.

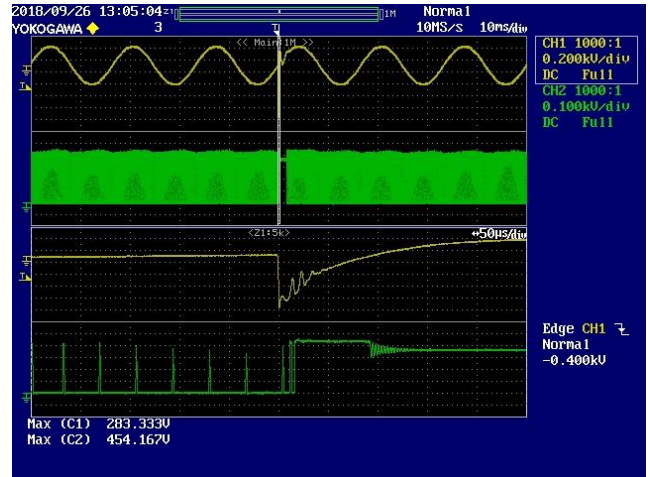

Figure 135 – (-)1 kV Differential Surge, 0° Phase Angle.
 Lower: V_{DRAIN} , 100 V / div., 10 ms / div.
 Peak V_{DRAIN} : 454.17 V.

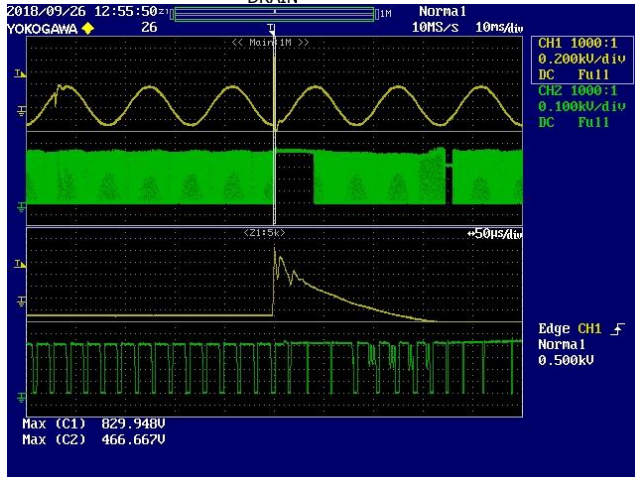

Figure 136 – (+)1 kV Differential Surge, 270° Phase Angle.
 Lower: V_{DRAIN} , 100 V / div., 10 ms / div.
 Peak V_{DRAIN} : 466.67 V.

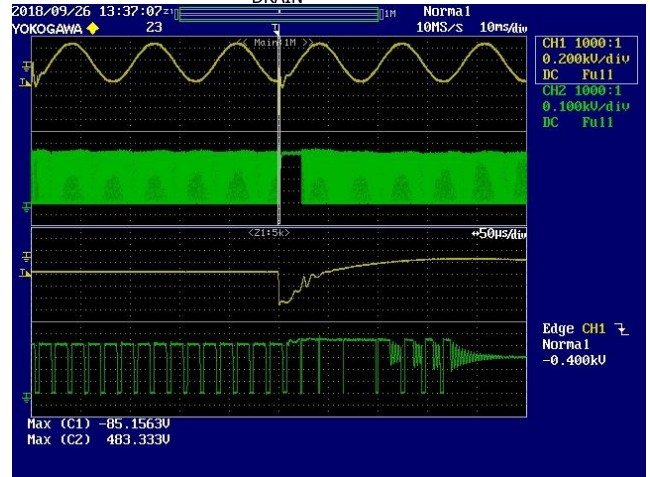

Figure 137 – (-)1 kV Differential Surge, 270° Phase Angle.
 Lower: V_{DRAIN} , 100 V / div., 10 ms / div.
 Peak V_{DRAIN} : 483.33 V.



21.5 2.5 kV Ring Wave Surge Test at 115 VAC

The Drain voltage of PFC driver PFS7626C was measured during 2.5 kV ring wave surge test at 115 VAC line input.

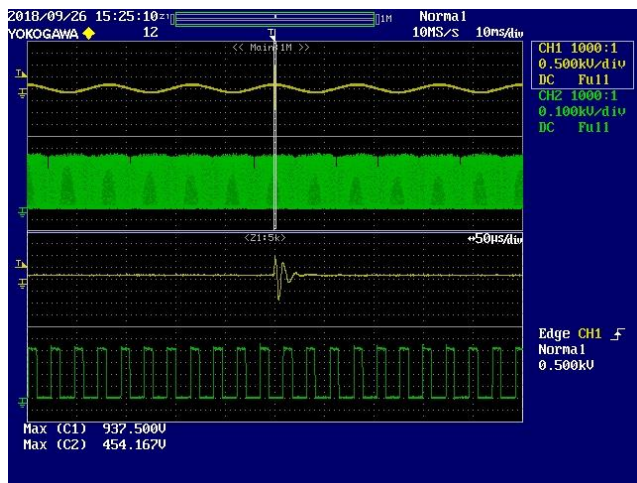

Figure 138 – (+) 2.5 kV Ring Wave Surge, 90° Phase Angle.
 Lower: V_{DRAIN} , 100 V / div., 10 ms / div.
 Peak V_{DRAIN} : 454.17 V.

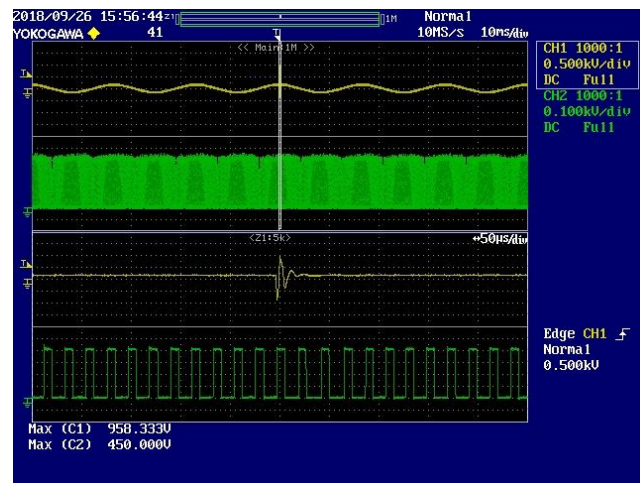

Figure 139 – (-) 2.5 kV Ring Wave Surge, 90° Phase Angle.
 Lower: V_{DRAIN} , 100 V / div., 10 ms / div.
 Peak V_{DRAIN} : 450 V.

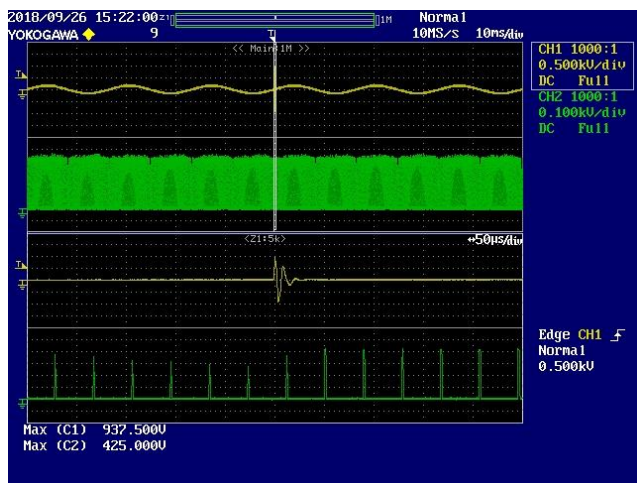

Figure 140 – (+) 2.5 kV Ring Wave Surge, 0° Phase Angle.
 Lower: V_{DRAIN} , 100 V / div., 10 ms / div.
 Peak V_{DRAIN} : 425 V.

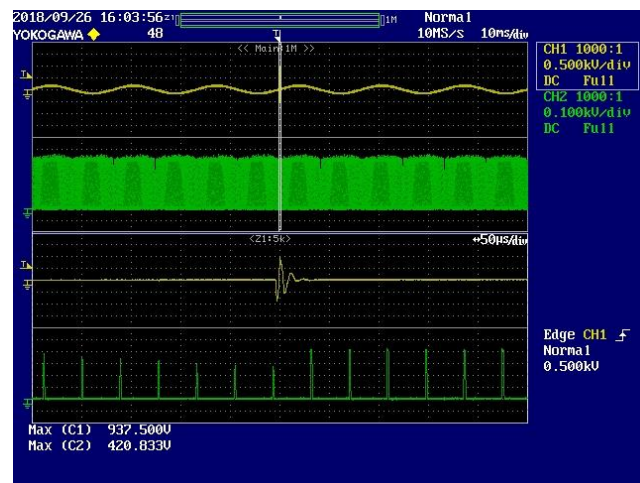

Figure 141 – (-) 2.5 kV Ring Wave Surge, 0° Phase Angle.
 Lower: V_{DRAIN} , 100 V / div., 10 ms / div.
 Peak V_{DRAIN} : 420.83 V.



Figure 142 – (+) 2.5 kV Ring Wave Surge, 270° Phase Angle.
 Lower: V_{DRAIN} , 100 V / div., 10 ms / div.
 Peak V_{DRAIN} : 454.17 V.

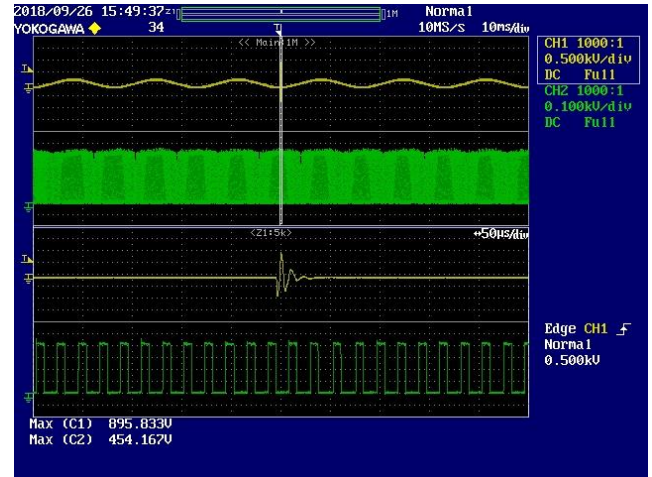

Figure 143 – (-) 2.5 kV Ring Wave Surge, 270° Phase Angle.
 Lower: V_{DRAIN} , 100 V / div., 10 ms / div.
 Peak V_{DRAIN} : 454.17 V.

21.6 2.5 kV Ring Wave Surge Test at 230 VAC

The Drain voltage of PFC driver PFS7626C was measured during 2.5 kV ring wave surge test at 230 VAC line input.

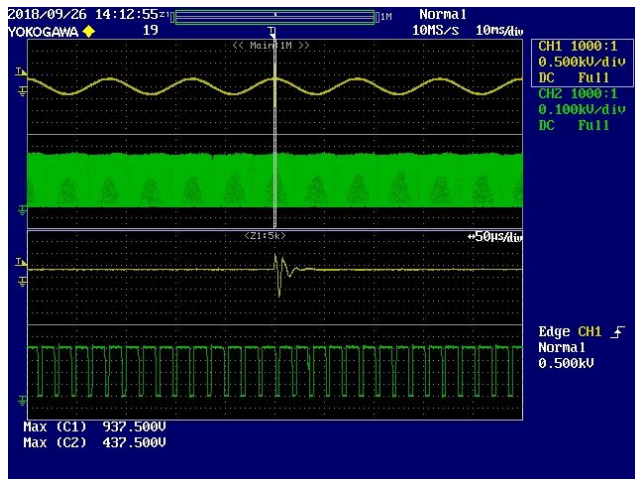

Figure 144 – (+) 2.5 kV Ring Wave Surge, 90° Phase Angle.
 Lower: V_{DRAIN} , 100 V / div., 10 ms / div.
 Peak V_{DRAIN} : 437.50 V.

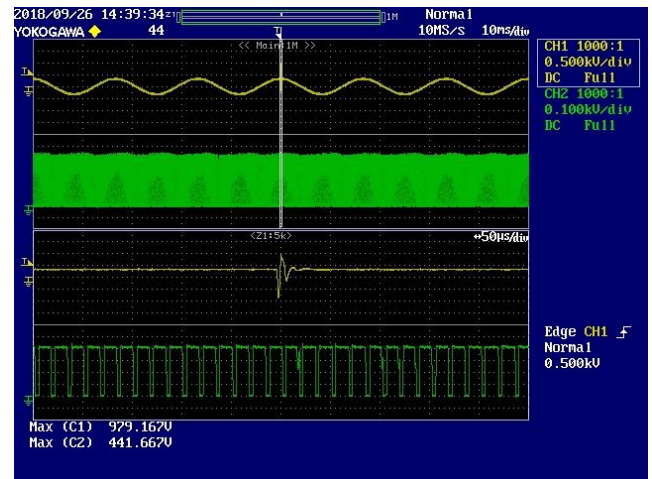

Figure 145 – (-) 2.5 kV Ring Wave Surge, 90° Phase Angle.
 Lower: V_{DRAIN} , 100 V / div., 10 ms / div.
 Peak V_{DRAIN} : 441.67 V.



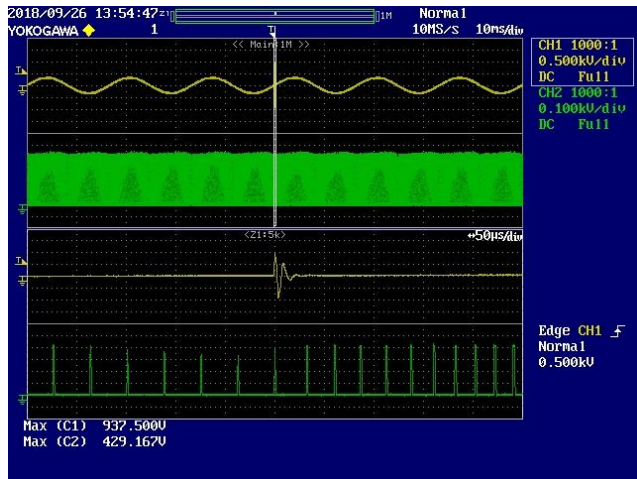

Figure 146 – (+) 2.5 kV Ring Wave Surge, 0° Phase Angle.
 Lower: V_{DRAIN} , 100 V / div., 10 ms / div.
 Peak V_{DRAIN} : 429.17 V.

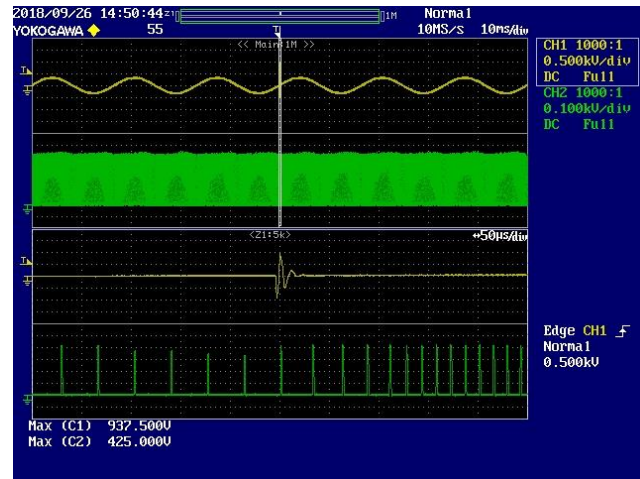

Figure 147 – (-) 2.5 kV Ring Wave Surge, 0° Phase Angle.
 Lower: V_{DRAIN} , 100 V / div., 10 ms / div.
 Peak V_{DRAIN} : 425.50 V.

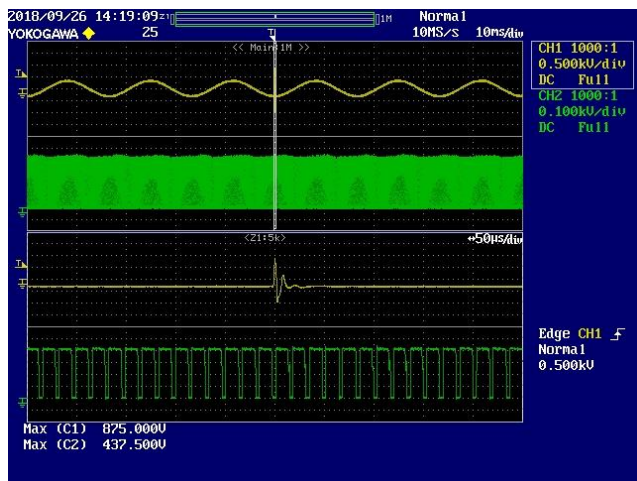

Figure 148 – (+) 2.5 kV Ring Wave Surge, 270° Phase Angle.
 Lower: V_{DRAIN} , 100 V / div., 10 ms / div.
 Peak V_{DRAIN} : 437.50 V.

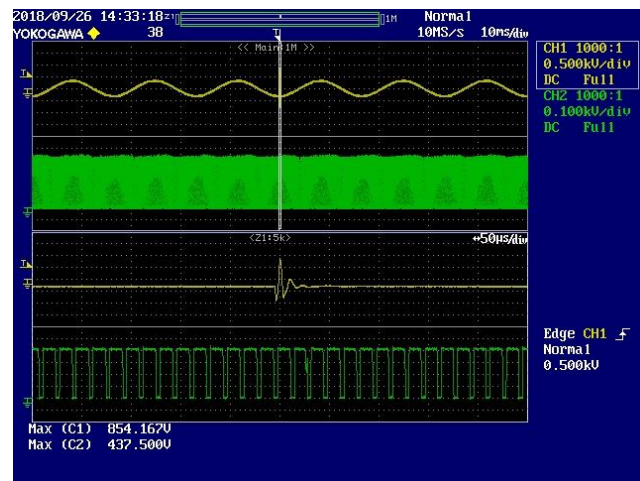

Figure 149 – (-) 2.5 kV Ring Wave Surge, 270° Phase Angle.
 Lower: V_{DRAIN} , 100 V / div., 10 ms / div.
 Peak V_{DRAIN} : 437.50 V.

22 Brown-in/Brown-out Test

No abnormal overheating, current overshoot/undershoot was observed during and after 0.5 V / s and 1 V / s brown in and brown out test.

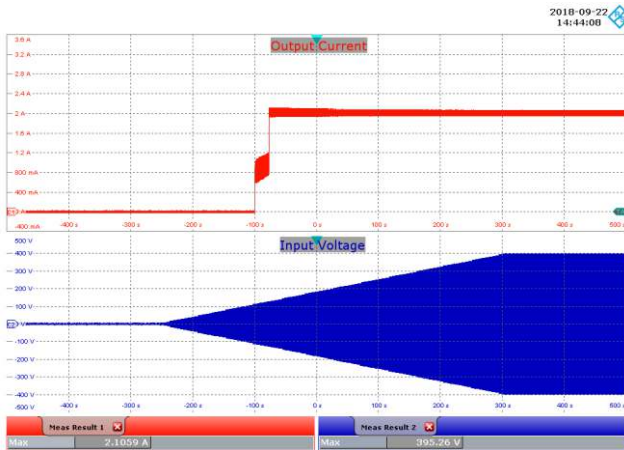

Figure 150 – Brown-in Test at 0.5 V / s.
 Ch1: I_{OUT} , 400 mA / div.
 Ch2: V_{IN} , 100 V / div.
 Time Scale: 100 s / div.

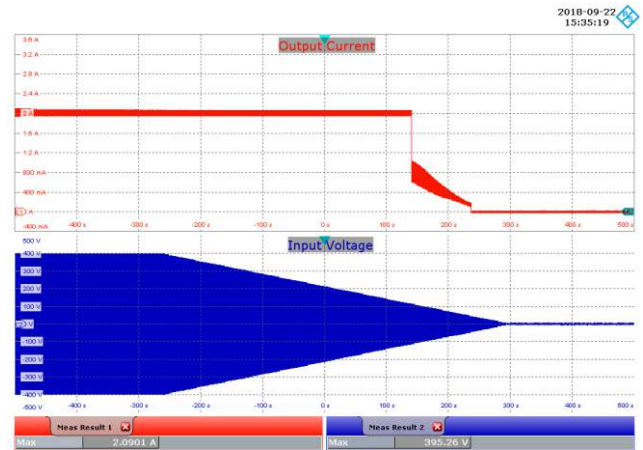

Figure 151 – Brown-out Test at 0.5 V / s
 Ch1: I_{OUT} , 400 mA / div.
 Ch2: V_{IN} , 100 V / div.
 Time Scale: 100 s / div.

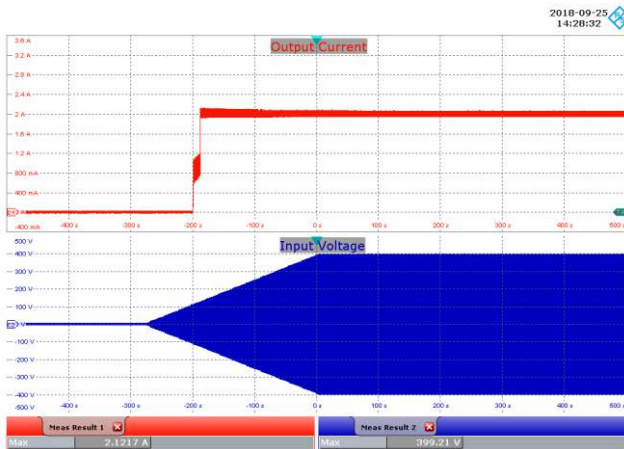

Figure 152 – Brown-in Test at 1 V / s.
 Ch1: I_{OUT} , 400 mA / div.
 Ch2: V_{IN} , 100 V / div.
 Time Scale: 100 s / div.

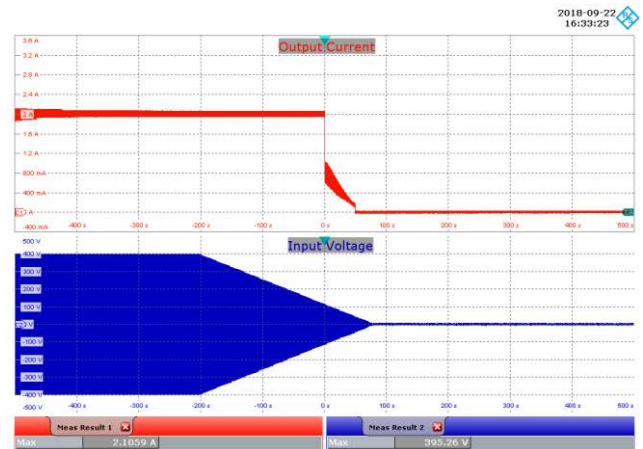

Figure 153 – Brown-out Test at 1 V / s.
 Ch1: I_{OUT} , 400 mA / div.
 Ch2: V_{IN} , 100 V / div.
 Time Scale: 100 s / div.

23 Revision History

Date	Author	Revision	Description and Changes	Reviewed
08-Aug-19	JB	1.0	Initial Release.	Apps & Mktg
16-Sep-19	JB	1.1	Updated Power Section Schematic.	Apps & Mktg
04-Dec-19	JB	1.2	Transformer Design Update.	Apps & Mktg
17-Jul-20	KM	1.3	Converted to RDR. Updated Schematic and BOM. Added Section 9 and 10.	Apps & Mktg

For the latest updates, visit our website: www.power.com

Reference Designs are technical proposals concerning how to use Power Integrations' gate drivers in particular applications and/or with certain power modules. These proposals are "as is" and are not subject to any qualification process. The suitability, implementation and qualification are the sole responsibility of the end user. The statements, technical information and recommendations contained herein are believed to be accurate as of the date hereof. All parameters, numbers, values and other technical data included in the technical information were calculated and determined to our best knowledge in accordance with the relevant technical norms (if any). They may base on assumptions or operational conditions that do not necessarily apply in general. We exclude any representation or warranty, express or implied, in relation to the accuracy or completeness of the statements, technical information and recommendations contained herein. No responsibility is accepted for the accuracy or sufficiency of any of the statements, technical information, recommendations or opinions communicated and any liability for any direct, indirect or consequential loss or damage suffered by any person arising therefrom is expressly disclaimed.

Power Integrations reserves the right to make changes to its products at any time to improve reliability or manufacturability. Power Integrations does not assume any liability arising from the use of any device or circuit described herein. POWER INTEGRATIONS MAKES NO WARRANTY HEREIN AND SPECIFICALLY DISCLAIMS ALL WARRANTIES INCLUDING, WITHOUT LIMITATION, THE IMPLIED WARRANTIES OF MERCHANTABILITY, FITNESS FOR A PARTICULAR PURPOSE, AND NON-INFRINGEMENT OF THIRD PARTY RIGHTS.

Patent Information

The products and applications illustrated herein (including transformer construction and circuits' external to the products) may be covered by one or more U.S. and foreign patents, or potentially by pending U.S. and foreign patent applications assigned to Power Integrations. A complete list of Power Integrations' patents may be found at www.power.com. Power Integrations grants its customers a license under certain patent rights as set forth at <http://www.power.com/ip.htm>.

Power Integrations, the Power Integrations logo, CAPZero, ChiPhy, CHY, DPA-Switch, EcoSmart, E-Shield, eSIP, eSOP, HiperPLC, HiperPFS, HiperTFS, InnoSwitch, Innovation in Power Conversion, InSOP, LinkSwitch, LinkZero, LYTSwitch, SENZero, TinySwitch, TOPSwitch, PI, PI Expert, SCALE, SCALE-1, SCALE-2, SCALE-3 and SCALE-iDriver, are trademarks of Power Integrations, Inc. Other trademarks are property of their respective companies. ©2019, Power Integrations, Inc.

Power Integrations Worldwide Sales Support Locations

WORLD HEADQUARTERS

5245 Hellyer Avenue
San Jose, CA 95138, USA.
Main: +1-408-414-9200
Customer Service:
Worldwide: +1-65-635-64480
Americas: +1-408-414-9621
e-mail: usasales@power.com

CHINA (SHANGHAI)

Rm 2410, Charity Plaza, No. 88,
North Caoxi Road,
Shanghai, PRC 200030
Phone: +86-21-6354-6323
e-mail: chinasales@power.com

CHINA (SHENZHEN)

17/F, Hivac Building, No. 2, Keji
Nan 8th Road, Nanshan District,
Shenzhen, China, 518057
Phone: +86-755-8672-8689
e-mail: chinasales@power.com

GERMANY (AC-DC/LED Sales)

Einsteinring 24
85609 Dornach/Aschheim
Germany
Tel: +49-89-5527-39100
e-mail: eurosales@power.com

GERMANY (Gate Driver Sales)

HellwegForum 1
59469 Ense
Germany
Tel: +49-2938-64-39990
e-mail: igbt-driver.sales@power.com

INDIA

#1, 14th Main Road
Vasanthanagar
Bangalore-560052
India
Phone: +91-80-4113-8020
e-mail: indiasales@power.com

ITALY

Via Milanese 20, 3rd. Fl.
20099 Sesto San Giovanni (MI) Italy
Phone: +39-024-550-8701
e-mail: eurosales@power.com

JAPAN

Yusen Shin-Yokohama 1-chome Bldg.
1-7-9, Shin-Yokohama, Kohoku-ku
Yokohama-shi,
Kanagawa 222-0033 Japan
Phone: +81-45-471-1021
e-mail: japansales@power.com

KOREA

RM 602, 6FL
Korea City Air Terminal B/D,
159-6
Samsung-Dong, Kangnam-Gu,
Seoul, 135-728 Korea
Phone: +82-2-2016-6610
e-mail: koreasales@power.com

SINGAPORE

51 Newton Road,
#19-01/05 Goldhill Plaza
Singapore, 308900
Phone: +65-6358-2160
e-mail: singaporesales@power.com

TAIWAN

5F, No. 318, Nei Hu Rd.,
Sec. 1
Nei Hu District
Taipei 11493, Taiwan R.O.C.
Phone: +886-2-2659-4570
e-mail: taiwansales@power.com

UK

Building 5, Suite 21
The Westbrook Centre
Milton Road
Cambridge
CB4 1YG
Phone: +44 (0) 7823-557484
e-mail: eurosales@power.com

