

BLF872

UHF power LDMOS transistor

Rev. 01 — 20 February 2006

Product data sheet

1. Product profile

1.1 General description

A 300 W LDMOS RF power transistor for broadcast transmitter applications and industrial applications. The transistor can deliver 250 W broadband over the full UHF band from 470 MHz to 860 MHz. The excellent ruggedness and broadband performance of this device makes it ideal for digital transmitter applications.

CAUTION



This device is sensitive to ElectroStatic Discharge (ESD). Therefore care should be taken during transport and handling.

1.2 Features

- Typical 2-tone performance at 860 MHz, a drain-source voltage V_{DS} of 32 V and a quiescent drain current $I_{DQ} = 2 \times 0.9$ A:
 - ◆ Peak envelope power load power $P_{L(PEP)} = 300$ W
 - ◆ Gain $G_p = 15$ dB
 - ◆ Drain efficiency $\eta_D = 43$ %
 - ◆ Third order intermodulation distortion $IMD3 = -28$ dBc
- Typical DVB performance at 858 MHz, a drain-source voltage V_{DS} of 32 V and a quiescent drain current $I_{DQ} = 2 \times 0.9$ A:
 - ◆ Average output power $P_{L(AV)} = 70$ W
 - ◆ Gain $G_p = 15$ dB
 - ◆ Drain efficiency $\eta_D = 30$ %
 - ◆ Third order intermodulation distortion $IMD3 = -28$ dBc (4.3 MHz from center frequency)
- Advanced flange material for optimum thermal behavior and reliability
- Excellent ruggedness
- High power gain
- Designed for broadband operation (UHF band)
- Excellent reliability
- Internal input and output matching for high gain and optimum broadband operation
- Source on underside eliminates DC isolators, reducing common-mode inductance
- Easy power control

PHILIPS

1.3 Applications

- Communication transmitter applications in the UHF band
- Industrial applications in the UHF band

1.4 Quick reference data

Table 1: Quick reference data

Typical RF performance at $V_{DS} = 32\text{ V}$ and $T_h = 25\text{ °C}$ in a common-source narrowband 860 MHz test circuit. [1]

Mode of operation	f (MHz)	P _L (W)	P _{L(PEP)} (W)	P _{L(AV)} (W)	G _p (dB)	η _D (%)	IMD3 (dBc)
CW, class AB	860	300	-	-	14	55	-
2-tone, class AB	f ₁ = 860; f ₂ = 860.1	-	300	-	15	42	-28
PAL BG	860 (ch69)	300 (peak sync.) [2]	-	-	15	42	-
DVB-T (8K OFDM)	858	-	-	70	15	30	-28 [3]

[1] T_h is the heatsink temperature.

[2] Black video signal, sync expansion: input sync = 33 %; output sync ≥ 27 %.

[3] Measured dBc at 4.3 MHz from center frequency.

2. Pinning information

Table 2: Pinning

Description	Pin	Simplified outline
drain 1	1	
drain 2	2	
gate 1	3	
gate 2	4	
source	5	

[1] Connected to flange.

3. Ordering information

Table 3: Ordering information

Type number	Package		
	Name	Description	Version
BLF872	-	flanged LDMOST ceramic package; 2 mounting holes; 4 leads	SOT800-1

4. Limiting values

Table 4: Limiting values

In accordance with the Absolute Maximum Rating System (IEC 60134).

Symbol	Parameter	Conditions	Min	Max	Unit
V_{DS}	drain-source voltage		-	65	V
V_{GS}	gate-source voltage		-	±13	V
T_{stg}	storage temperature		-65	+150	°C
T_j	junction temperature		-	200	°C

5. Thermal characteristics

Table 5: Thermal characteristics

Symbol	Parameter	Conditions	Typ	Unit
$R_{th(j-c)}$	thermal resistance from junction to case	$T_h = 25\text{ °C}$	[1] 0.32	K/W
$R_{th(j-h)}$	thermal resistance from junction to heatsink	$T_h = 25\text{ °C}$	[1][2] 0.4	K/W

[1] T_h is the heatsink temperature.

[2] $R_{th(j-h)}$ is dependent on the applied thermal compound and clamping/mounting of the device.

6. Characteristics

Table 6: Characteristics

$T_j = 25\text{ °C}$ unless otherwise specified.

Symbol	Parameter	Conditions [1]	Min	Typ	Max	Unit
$V_{(BR)DSS}$	drain-source breakdown voltage	$V_{GS} = 0\text{ V}; I_D = 5\text{ mA}$	65	-	-	V
V_{GSth}	gate-source threshold voltage	$V_{DS} = 20\text{ V}; I_D = 250\text{ mA}$	5.2	-	6.2	V
I_{DSS}	drain leakage current	$V_{GS} = 0\text{ V}; V_{DS} = 32\text{ V}$	-	-	2.2	µA
I_{DSX}	drain cut-off current	$V_{GS} = V_{GSth} + 6\text{ V}; V_{DS} = 10\text{ V}$	-	41	-	A
I_{GSS}	gate leakage current	$V_{GS} = 10\text{ V}; V_{DS} = 0\text{ V}$	-	-	40	nA
g_{fs}	forward transconductance	$V_{GS} = 20\text{ V}; I_D = 16\text{ A}$	-	10	-	S
R_{DSon}	drain-source on-state resistance	$V_{GS} = V_{GSth} + 6\text{ V}; I_D = 9\text{ A}$	-	80	-	mΩ
C_{iss}	input capacitance	$V_{GS} = 0\text{ V}; V_{DS} = 32\text{ V}; f = 1\text{ MHz}$	[2] -	200	-	pF
C_{oss}	output capacitance	$V_{GS} = 0\text{ V}; V_{DS} = 32\text{ V}; f = 1\text{ MHz}$	[2] -	70	-	pF
C_{rss}	reverse transfer capacitance	$V_{GS} = 0\text{ V}; V_{DS} = 32\text{ V}; f = 1\text{ MHz}$	[2] -	2.5	-	pF

[1] I_D is the drain current.

[2] Capacitance values without internal matching.

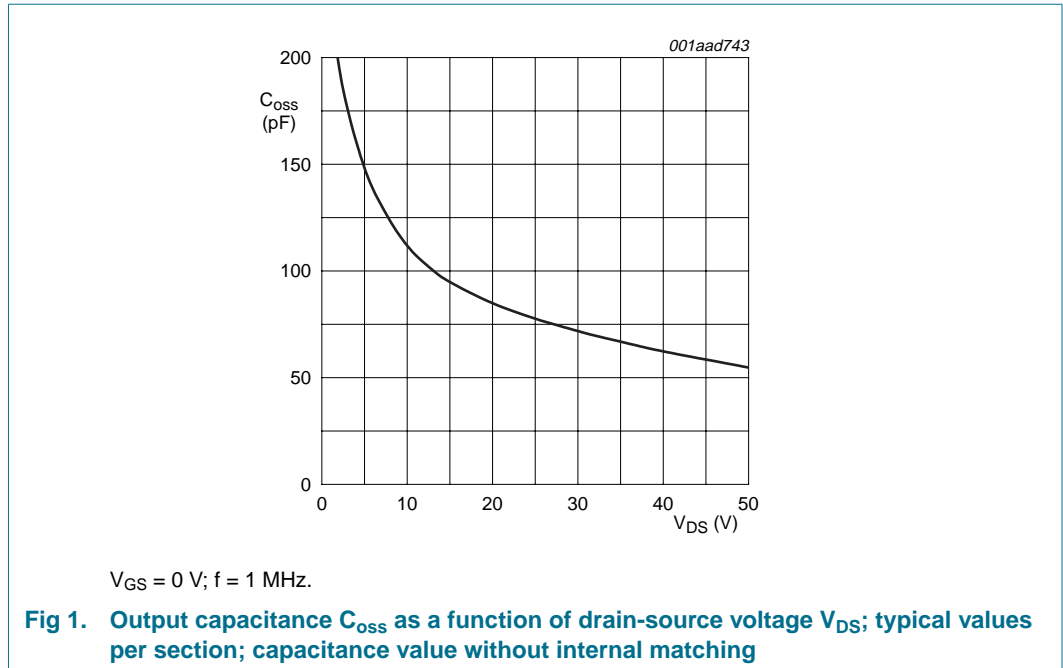

7. Application information

Table 7: RF performance in a common-source 860 MHz narrowband test circuit

$T_h = 25^\circ\text{C}$ unless otherwise specified. [\[1\]](#)

Mode of operation	f (MHz)	V_{DS} (V)	I_{Dq} (A)	$P_{L(PEP)}$ (W)	$P_{L(AV)}$ (W)	G_p (dB)	η_D (%)	IMD3 (dBc)	ΔG_p (dB)
2-tone, class AB	$f_1 = 860;$ $f_2 = 860.1$	32	2×0.9	300	-	> 14	> 40	≤ -25	≤ 1
DVB-T (8K OFDM)	858	32	2×0.9	-	70	> 14	> 26	≤ -25	-

[1] Sync. compression: input sync. $\geq 33\%$, output sync. 27% .

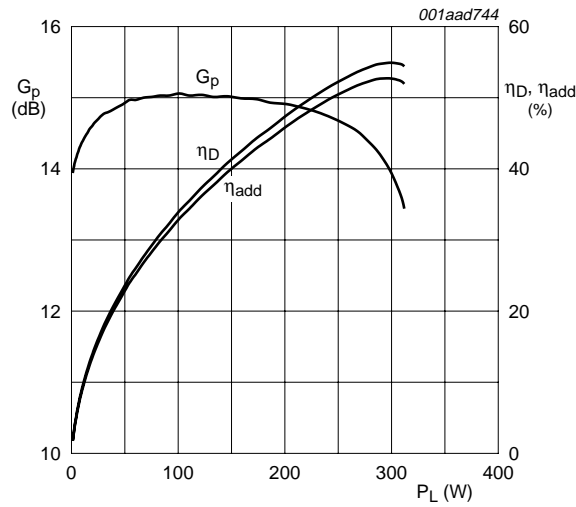

$V_{DS} = 32\text{ V}$; $f = 860\text{ MHz}$; $I_{Dq} = 2 \times 0.9\text{ A}$; $T_h = 25\text{ }^\circ\text{C}$.

Fig 2. CW power gain G_p , drain efficiency η_D and power added efficiency η_{add} as a function of output power P_L ; typical values

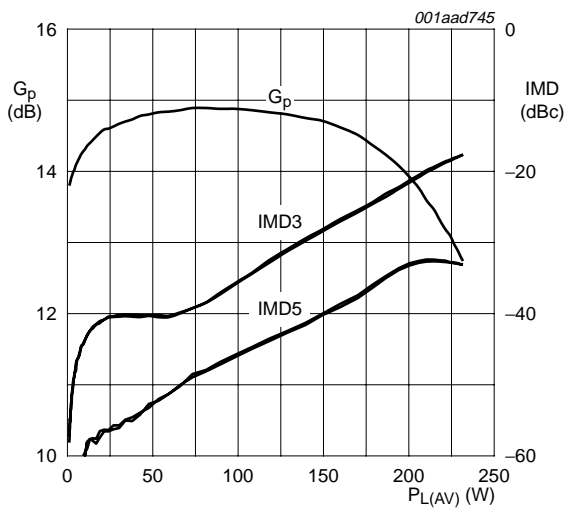

$V_{DS} = 32\text{ V}$; $f_1 = 860\text{ MHz}$; $f_2 = 860.1\text{ MHz}$;
 $I_{Dq} = 2 \times 0.9\text{ A}$; $T_h = 25\text{ }^\circ\text{C}$.

Fig 3. 2-tone power gain G_p and intermodulation distortion IMD as a function of average output power $P_{L(AV)}$; typical values

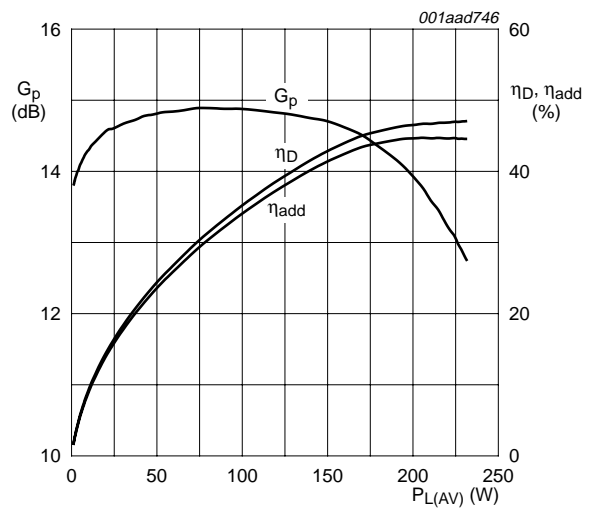

$V_{DS} = 32\text{ V}$; $f_1 = 860\text{ MHz}$; $f_2 = 860.1\text{ MHz}$;
 $I_{Dq} = 2 \times 0.9\text{ A}$; $T_h = 25\text{ }^\circ\text{C}$.

Fig 4. 2-tone power gain G_p , drain efficiency η_D and power added efficiency η_{add} as a function of average output power $P_{L(AV)}$; typical values

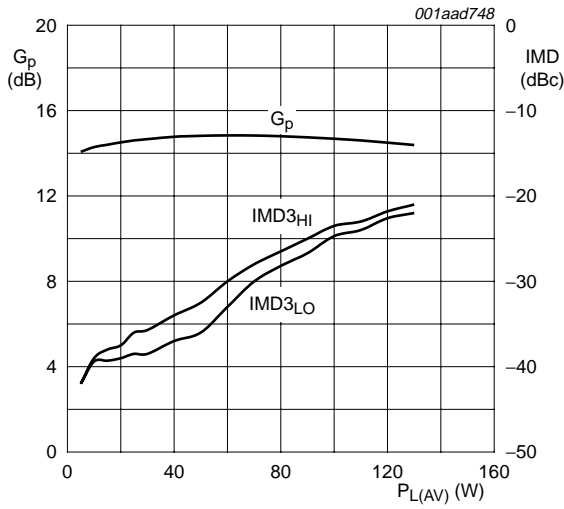

IMD at ± 4.3 MHz from frequency center.

Fig 5. DVB-T (8K OFDM) power gain G_p and third order intermodulation distortion (high-frequency component IMD_{3HI} and low-frequency component IMD_{3LO}) as a function of average output power $P_{L(AV)}$; typical values

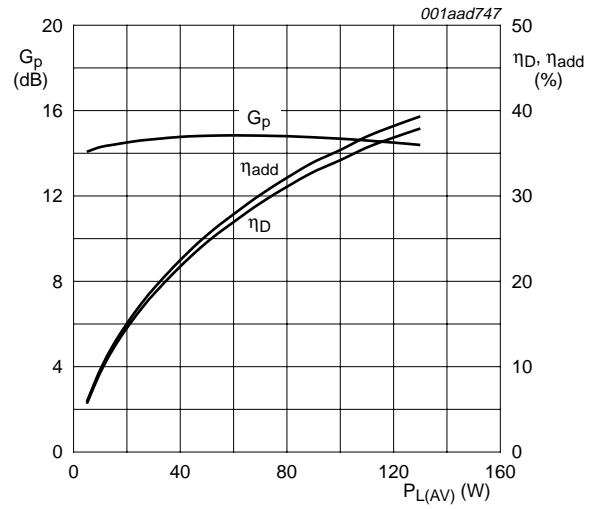

$V_{DS} = 32$ V; $f = 858$ MHz; $I_{Dq} = 2 \times 0.9$ A; $T_h = 25$ °C.

Fig 6. DVB-T (8K OFDM) power gain G_p , drain efficiency η_D and power added efficiency η_{add} as a function of average output power $P_{L(AV)}$; typical values

7.1 Broadband operation data

Measured in a common-source broadband (470 MHz to 860 MHz) test circuit.

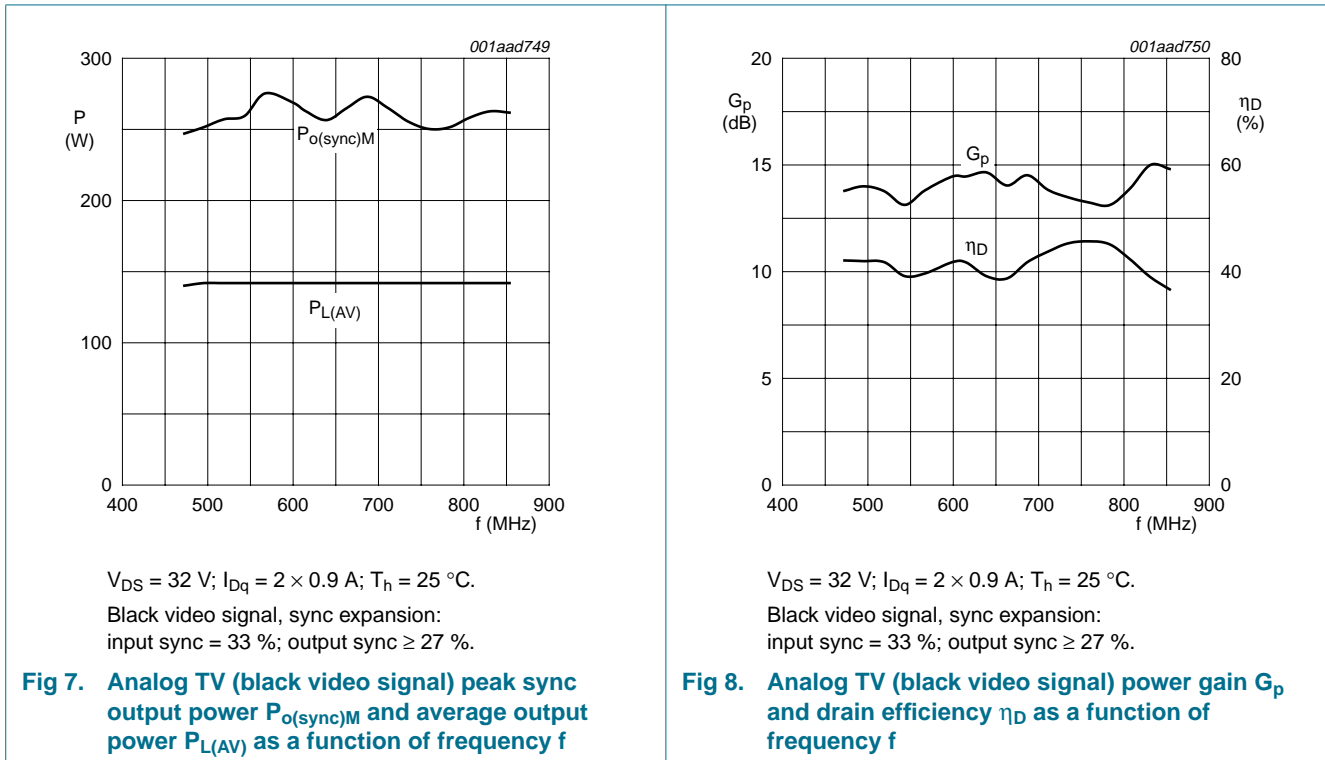

7.2 Ruggedness in class-AB operation

The BLF872 is capable of withstanding a load mismatch corresponding to $V_{SWR} = 10 : 1$ through all phases under the following conditions: $V_{DS} = 32\text{ V}; f = 860\text{ MHz}$ at rated power.

Measured in a common-source broadband (470 MHz to 860 MHz) test circuit.

7.3 Reliability

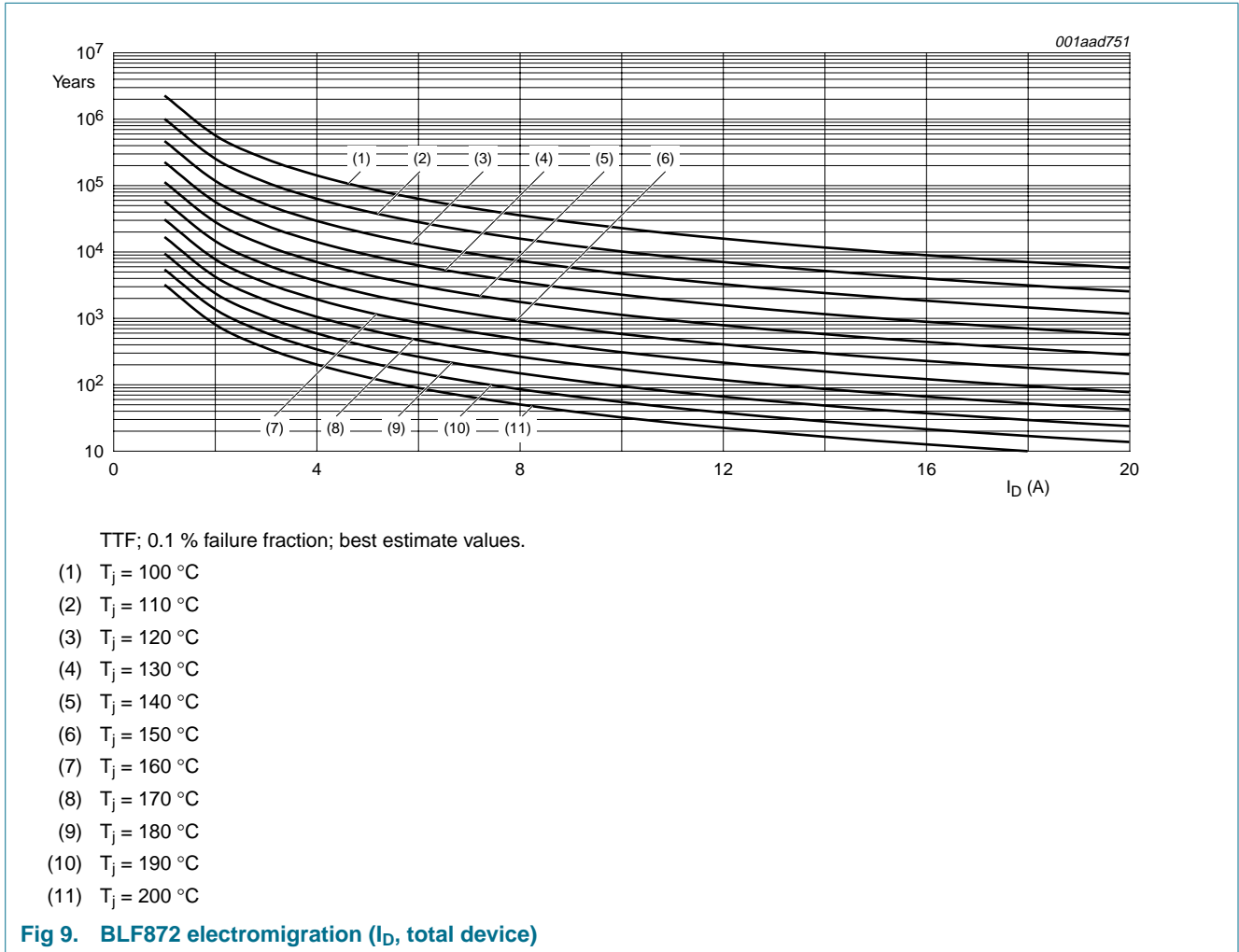

8. Test information

Table 8: List of components

For test circuit, see [Figure 10](#), [11](#) and [12](#).

Component	Description	Value	Remarks
B1, B2 balun	semi rigid coax	25 Ω	EZ90-25-TP
C1	multilayer ceramic chip capacitor	12 pF	[1]
C2	multilayer ceramic chip capacitor	10 pF	[1]
C3, C5	multilayer ceramic chip capacitor	5.6 pF	[1]
C4	multilayer ceramic chip capacitor	6.8 pF	[1]
C6, C7	multilayer ceramic chip capacitor	2.0 pF	[2]
C8	multilayer ceramic chip capacitor	18 pF	[1]
C9, C10	multilayer ceramic chip capacitor	0.5 pF	[2]
C11, C12	multilayer ceramic chip capacitor	100 pF	[1]
C13, C14	multilayer ceramic chip capacitor	100 pF	[2]

Table 8: List of components ...continued
For test circuit, see [Figure 10](#), [11](#) and [12](#).

Component	Description	Value	Remarks
C15, C16	ceramic capacitor	15 nF	
C17, C18	electrolytic capacitor	470 μ F	
C20	multilayer ceramic chip capacitor	13 pF	[3]
C21	tekelec trimmer	0.6 pF to 4.5 pF	
C22	multilayer ceramic chip capacitor	3.9 pF	[3]
C23	multilayer ceramic chip capacitor	10 pF	[3]
C24, C32	multilayer ceramic chip capacitor	3.0 pF	[3]
C25	multilayer ceramic chip capacitor	30 pF	[3]
C26, C27	multilayer ceramic chip capacitor	100 pF	[3]
C28, C29	ceramic capacitor	15 nF	
C30, C31	electrolytic capacitor	10 μ F	
L1	stripline		[4] (W \times L) 24 mm \times 13.1 mm
L2	stripline		[4] (W \times L) 10 mm \times 17.7 mm
L3	stripline		[4] (W \times L) 5 mm \times 16.5 mm
L4	stripline		[4] (W \times L) 2.4 mm \times 15 mm
L5	stripline		[4] (W \times L) 3.5 mm \times 43 mm
L6	stripline		[4] (W \times L) 2 mm \times 43.3 mm
L10	stripline		[4] (W \times L) 24 mm \times 10 mm
L11	stripline		[4] (W \times L) 10 mm \times 15 mm
L12	stripline		[4] (W \times L) 3 mm \times 31.5 mm
L13	stripline		[4] (W \times L) 2 mm \times 43.3 mm
R1	resistor	5.6 Ω	
R2	resistor	5.6 Ω	
R3	resistor	100 Ω	
R4	resistor	100 Ω	
R5	potentiometer	2 k Ω	
R6	potentiometer	2 k Ω	

[1] American technical ceramics type 180R or capacitor of same quality.

[2] American technical ceramics type 100B or capacitor of same quality.

[3] American technical ceramics type 100A or capacitor of same quality.

[4] PCB: Rogers 5880; $\epsilon_r = 2.2$ F/m; height = 0.79 mm; Cu (top/bottom metallization); thickness copper plating = 35 μ m.

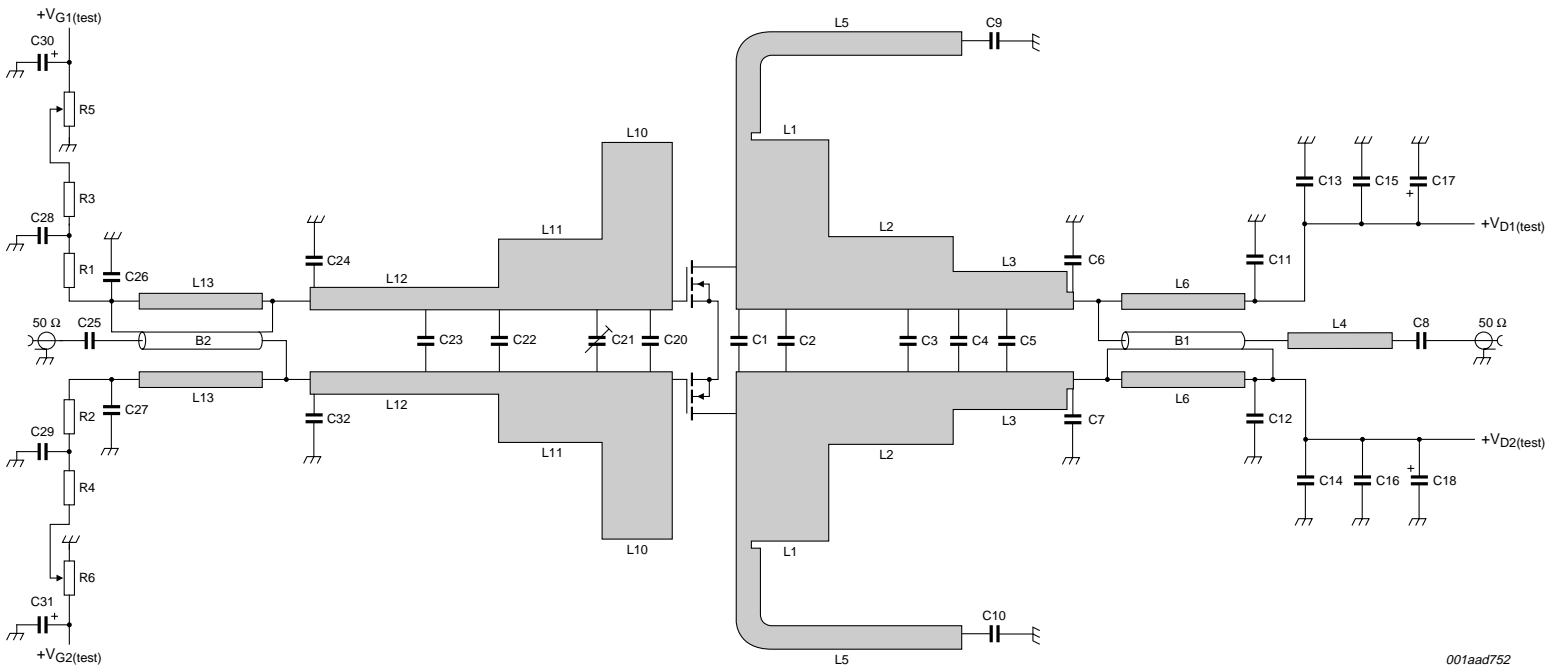

001aad752

Fig 10. Class-AB common-source broadband test circuit; $V_{D1(test)}$, $V_{D2(test)}$, $V_{G1(test)}$ and $V_{G2(test)}$ are drain and gate test voltages

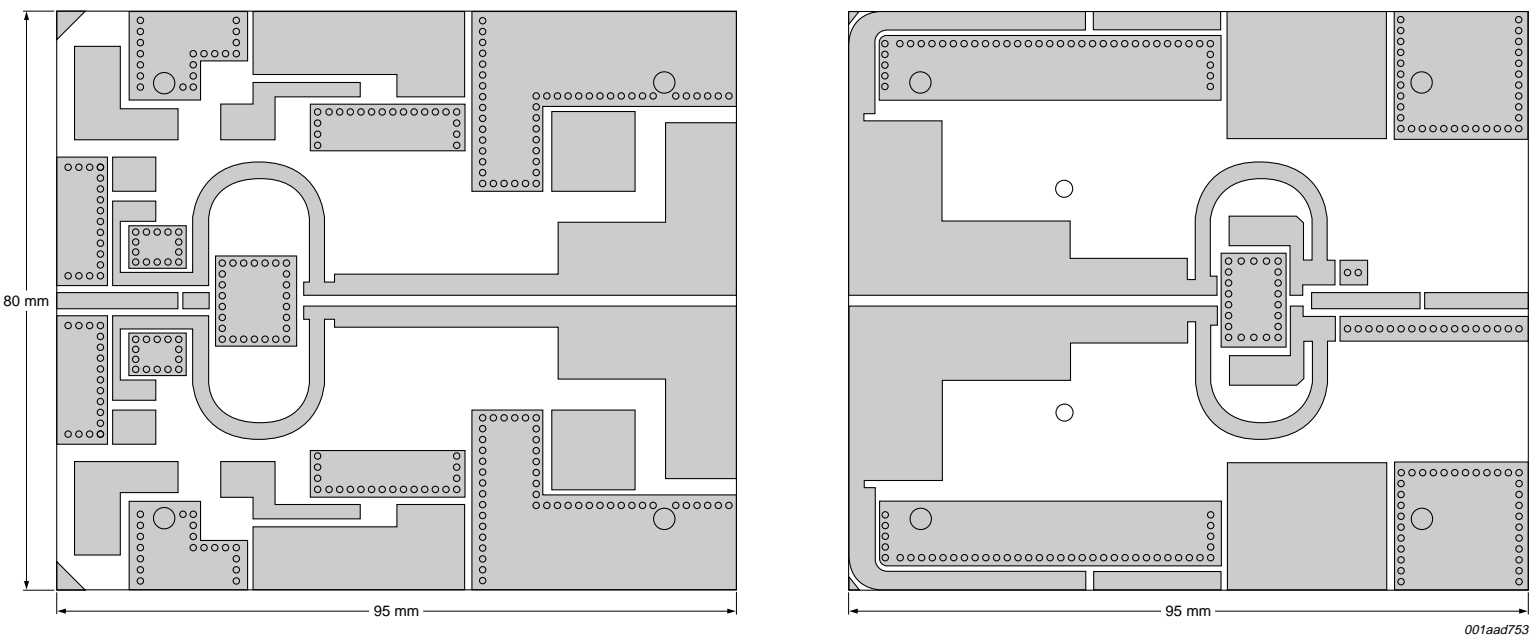

Fig 11. Printed-circuit board for class-AB broadband test circuit

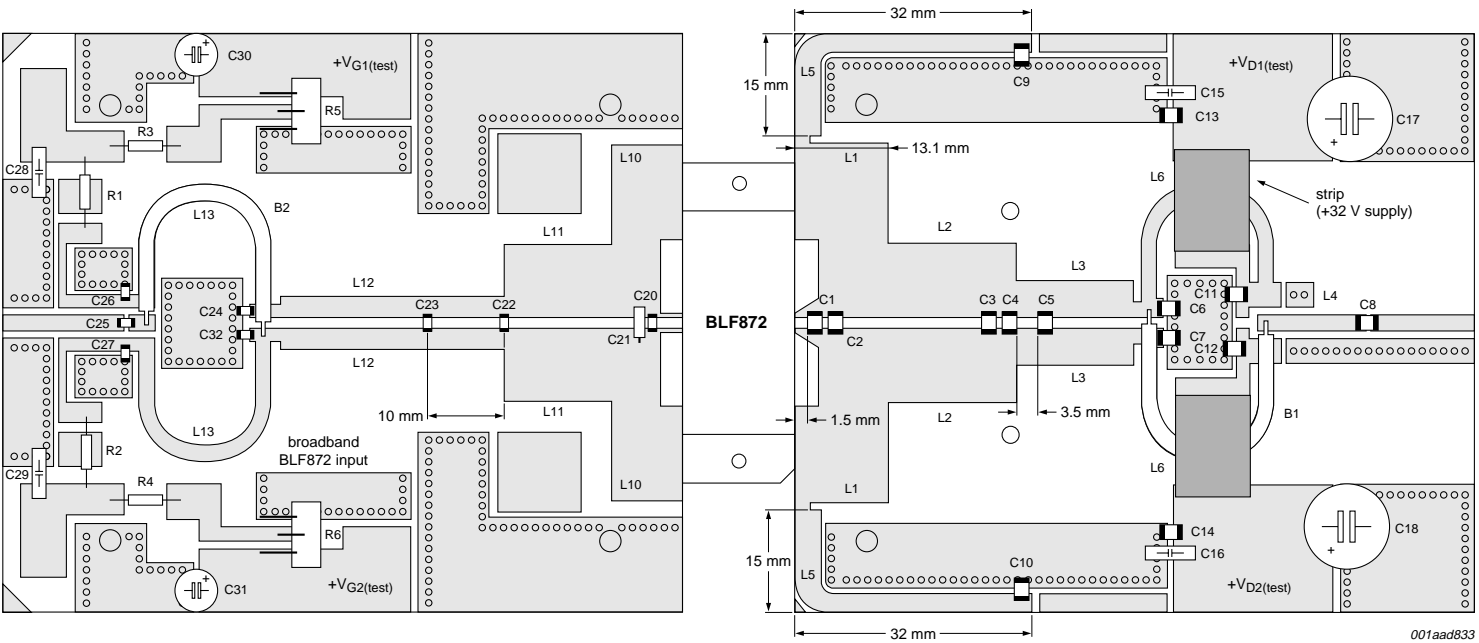

Fig 12. Component layout for class-AB broadband test circuit

9. Package outline

Flanged LDMOST ceramic package; 2 mounting holes; 4 leads

SOT800-1

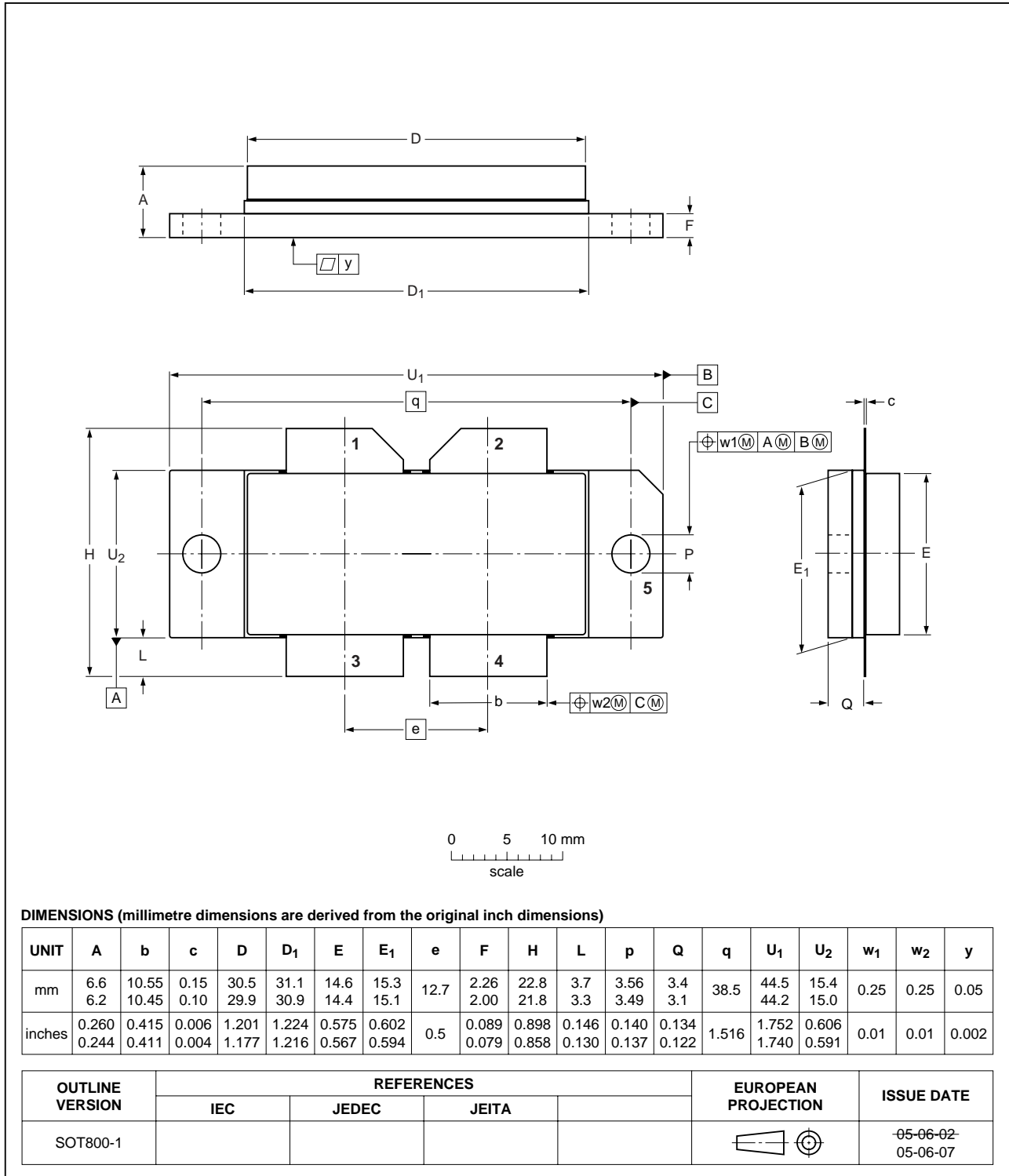

Fig 13. Package outline SOT800-1

10. Abbreviations

Table 9: Abbreviations

Acronym	Description
CDMA	Code Division Multiple Access
CW	Continuous Wave
DVB	Digital Video Broadcast
EDGE	Enhanced Data rates for GSM Evolution
ESR	Equivalent Series Resistance
EVM	Error Vector Magnitude
GSM	Global System for Mobile communications
IMD	InterModulation Distortion
LDMOS	Laterally Diffused Metal Oxide Semiconductor
OFDM	Orthogonal Frequency Division Multiplexing
PCB	Printed-Circuit Board
PEP	Peak Envelope Power
RF	Radio Frequency
SMD	Surface Mount Device
TTF	Time To Failure
VSWR	Voltage Standing Wave Ratio

11. Revision history

Table 10: Revision history

Document ID	Release date	Data sheet status	Change notice	Doc. number	Supersedes
BLF872_1	20060220	Product data sheet	-	-	-

12. Data sheet status

Level	Data sheet status ^[1]	Product status ^[2] ^[3]	Definition
I	Objective data	Development	This data sheet contains data from the objective specification for product development. Philips Semiconductors reserves the right to change the specification in any manner without notice.
II	Preliminary data	Qualification	This data sheet contains data from the preliminary specification. Supplementary data will be published at a later date. Philips Semiconductors reserves the right to change the specification without notice, in order to improve the design and supply the best possible product.
III	Product data	Production	This data sheet contains data from the product specification. Philips Semiconductors reserves the right to make changes at any time in order to improve the design, manufacturing and supply. Relevant changes will be communicated via a Customer Product/Process Change Notification (CPCN).

[1] Please consult the most recently issued data sheet before initiating or completing a design.

[2] The product status of the device(s) described in this data sheet may have changed since this data sheet was published. The latest information is available on the Internet at URL <http://www.semiconductors.philips.com>.

[3] For data sheets describing multiple type numbers, the highest-level product status determines the data sheet status.

13. Definitions

Short-form specification — The data in a short-form specification is extracted from a full data sheet with the same type number and title. For detailed information see the relevant data sheet or data handbook.

Limiting values definition — Limiting values given are in accordance with the Absolute Maximum Rating System (IEC 60134). Stress above one or more of the limiting values may cause permanent damage to the device. These are stress ratings only and operation of the device at these or at any other conditions above those given in the Characteristics sections of the specification is not implied. Exposure to limiting values for extended periods may affect device reliability.

Application information — Applications that are described herein for any of these products are for illustrative purposes only. Philips Semiconductors makes no representation or warranty that such applications will be suitable for the specified use without further testing or modification.

14. Disclaimers

Life support — These products are not designed for use in life support appliances, devices, or systems where malfunction of these products can reasonably be expected to result in personal injury. Philips Semiconductors

16. Contact information

For additional information, please visit: <http://www.semiconductors.philips.com>

For sales office addresses, send an email to: sales.addresses@www.semiconductors.philips.com

customers using or selling these products for use in such applications do so at their own risk and agree to fully indemnify Philips Semiconductors for any damages resulting from such application.

Right to make changes — Philips Semiconductors reserves the right to make changes in the products - including circuits, standard cells, and/or software - described or contained herein in order to improve design and/or performance. When the product is in full production (status 'Production'), relevant changes will be communicated via a Customer Product/Process Change Notification (CPCN). Philips Semiconductors assumes no responsibility or liability for the use of any of these products, conveys no license or title under any patent, copyright, or mask work right to these products, and makes no representations or warranties that these products are free from patent, copyright, or mask work right infringement, unless otherwise specified.

15. Trademarks

Notice — All referenced brands, product names, service names and trademarks are the property of their respective owners.

17. Contents

1	Product profile	1
1.1	General description	1
1.2	Features	1
1.3	Applications	2
1.4	Quick reference data	2
2	Pinning information	2
3	Ordering information	2
4	Limiting values	3
5	Thermal characteristics	3
6	Characteristics	3
7	Application information	4
7.1	Broadband operation data	7
7.2	Ruggedness in class-AB operation	7
7.3	Reliability	8
8	Test information	8
9	Package outline	13
10	Abbreviations	14
11	Revision history	14
12	Data sheet status	15
13	Definitions	15
14	Disclaimers	15
15	Trademarks	15
16	Contact information	15



© Koninklijke Philips Electronics N.V. 2006

All rights are reserved. Reproduction in whole or in part is prohibited without the prior written consent of the copyright owner. The information presented in this document does not form part of any quotation or contract, is believed to be accurate and reliable and may be changed without notice. No liability will be accepted by the publisher for any consequence of its use. Publication thereof does not convey nor imply any license under patent- or other industrial or intellectual property rights.

Date of release: 20 February 2006
Document number: BLF872_1

Published in The Netherlands