



CY3273

# Cypress Low Voltage Powerline Communication Evaluation Kit Guide

Doc. # 001-55382 Rev. \*C

Cypress Semiconductor  
198 Champion Court  
San Jose, CA 95134-1709  
Phone (USA): 800.858.1810  
Phone (Intl): 408.943.2600  
<http://www.cypress.com>

## Copyrights

© Cypress Semiconductor Corporation, 2009-2011. The information contained herein is subject to change without notice. Cypress Semiconductor Corporation assumes no responsibility for the use of any circuitry other than circuitry embodied in a Cypress product. Nor does it convey or imply any license under patent or other rights. Cypress products are not warranted nor intended to be used for medical, life support, life saving, critical control or safety applications, unless pursuant to an express written agreement with Cypress. Furthermore, Cypress does not authorize its products for use as critical components in life-support systems where a malfunction or failure may reasonably be expected to result in significant injury to the user. The inclusion of Cypress products in life-support systems application implies that the manufacturer assumes all risk of such use and in doing so indemnifies Cypress against all charges.

Any Source Code (software and/or firmware) is owned by Cypress Semiconductor Corporation (Cypress) and is protected by and subject to worldwide patent protection (United States and foreign), United States copyright laws and international treaty provisions. Cypress hereby grants to licensee a personal, non-exclusive, non-transferable license to copy, use, modify, create derivative works of, and compile the Cypress Source Code and derivative works for the sole purpose of creating custom software and or firmware in support of licensee product to be used only in conjunction with a Cypress integrated circuit as specified in the applicable agreement. Any reproduction, modification, translation, compilation, or representation of this Source Code except as specified above is prohibited without the express written permission of Cypress.

Disclaimer: CYPRESS MAKES NO WARRANTY OF ANY KIND, EXPRESS OR IMPLIED, WITH REGARD TO THIS MATERIAL, INCLUDING, BUT NOT LIMITED TO, THE IMPLIED WARRANTIES OF MERCHANTABILITY AND FITNESS FOR A PARTICULAR PURPOSE. Cypress reserves the right to make changes without further notice to the materials described herein. Cypress does not assume any liability arising out of the application or use of any product or circuit described herein. Cypress does not authorize its products for use as critical components in life-support systems where a malfunction or failure may reasonably be expected to result in significant injury to the user. The inclusion of Cypress' product in a life-support systems application implies that the manufacturer assumes all risk of such use and in doing so indemnifies Cypress against all charges.

Use may be limited by and subject to the applicable Cypress software license agreement.

PSoC® is a registered trademark of Cypress Semiconductor Corporation. All products and company names mentioned in this document may be the trademarks of their respective holders.

Purchase of I2C components from Cypress or one of its sublicensed Associated Companies conveys a license under the Philips I2C Patent Rights to use these components in an I2C system, provided that the system conforms to the I2C Standard Specification as defined by Philips. As from October 1st, 2006 Philips Semiconductors has a new trade name - NXP Semiconductors.

## Flash Code Protection

Cypress products meet the specifications contained in their particular Cypress PSoC Data Sheets. Cypress believes that its family of PSoC products is one of the most secure families of its kind on the market today, regardless of how they are used. There may be methods, unknown to Cypress, that can breach the code protection features. Any of these methods, to our knowledge, would be dishonest and possibly illegal. Neither Cypress nor any other semiconductor manufacturer can guarantee the security of their code. Code protection does not mean that we are guaranteeing the product as "unbreakable."

Cypress is willing to work with the customer who is concerned about the integrity of their code. Code protection is constantly evolving. We at Cypress are committed to continuously improving the code protection features of our products.

# Contents



<b>1. Introduction</b>	<b>5</b>
1.1 Introduction to the Cypress PLC Solution .....	5
1.2 Using the Cypress PLC Solution .....	5
1.3 Kit Contents .....	7
1.4 Additional Learning Resources .....	7
1.5 Additional Requirements .....	8
1.6 Document Revision History .....	9
1.7 Documentation Conventions .....	9
<b>2. Getting Started</b>	<b>11</b>
2.1 Kit Installation .....	11
2.2 Software Installation .....	15
2.2.1 Before You Begin .....	15
2.2.2 Prerequisites .....	15
2.2.3 Installing PLC Control Panel Software .....	15
<b>3. PLC LV Evaluation Board</b>	<b>17</b>
3.1 Features .....	17
3.2 Functional Overview .....	17
3.2.1 Operating Conditions .....	17
3.3 Hardware Description .....	18
3.3.1 Power Supply Circuit .....	19
3.3.2 Transmit Amplifier Circuit .....	20
3.3.3 Transmit and Receive Coupling Circuit .....	21
3.3.4 Cypress Powerline Communication Transceiver and User Controls .....	22
3.4 Setting Up the PLC LV Board .....	23
3.4.1 I2C Header Settings .....	23
3.4.2 Setting Up Manual Addressing on PLC Boards .....	24
3.4.3 Setting Up the I2C Address of the Node .....	25
3.4.4 Jumper Settings for the PLC LV Boards .....	25
3.5 Code Example .....	26
3.6 Technical Reference .....	26
<b>A. Appendix</b>	<b>27</b>
A.1 Schematics .....	27
A.1.1 Board Overview .....	27
A.1.2 User Interface .....	28
A.1.3 Transmit Amplification and Receive Filter .....	29
A.1.4 Power Supply .....	30
A.2 Layout .....	31
A.2.1 Top Layer .....	31
A.2.2 Ground Layer .....	32

A.2.3	Power Layer.....	33
A.2.4	Bottom Layer .....	34
A.2.5	Top Silkscreen .....	35
A.2.6	Bottom Silkscreen .....	36
A.3	Bill of Materials .....	37

# 1. Introduction



## 1.1 Introduction to the Cypress PLC Solution

Cypress's Powerline Communication Solution (PLC) enables transmission of command and control data over high voltage and low voltage powerlines. This solution is developed for low bandwidth powerline communication.

The CY3273 PLC Low Voltage (LV) Evaluation Board demonstrates the ability of the Cypress CY8CPLC10 to transmit data at 2400 bps over low voltage (12 V to 24 V AC/DC) powerlines.

This guide includes the following chapters:

- Chapter 1 provides a brief overview of the Cypress PLC solution. It describes the contents of the CY3273 evaluation kit and lists additional requirements to run the code examples, which are included as part of the kit.
- Chapter 2 gives the functional and high level hardware description of the Cypress PLC LV boards. It also describes the setup and operating procedure of the PLC LV board. It describes features such as manual addressing, connection of USB-I2C bridge, and jumper settings with examples.
- The Appendix contains the schematics, layout, and bill of materials.

## 1.2 Using the Cypress PLC Solution

Powerlines are one of the most widely available communication media in the world. The pervasiveness of powerlines makes it difficult to predict its characteristics and noise. Because of the variable quality of powerline, implementing robust communication over powerline has been an engineering challenge for years. With this in mind, the Cypress PLC solution is designed to enable secure, reliable, and robust communication over powerline. Some of the features of Cypress PLC are:

- Integrated powerline PHY modem with optimized amplifiers to work with rugged low voltage powerlines.
- Powerline optimized network protocol that supports bidirectional communication with acknowledgement based signaling and multiple retries.
- Support for 8-bit packet CRC and 4-bit header CRC for error detection and data packet retransmission.
- Carrier Sense Multiple Access (CSMA) scheme that minimizes collisions between packet transmissions on the powerline.

The Cypress PLC solution consists of three key elements as shown in [Figure 1-1](#).

- Powerline network protocol layer
- Physical layer frequency shift keying (FSK) modem
- Power amplification and coupling circuits

Figure 1-1. Cypress PLC Solution Block Diagram

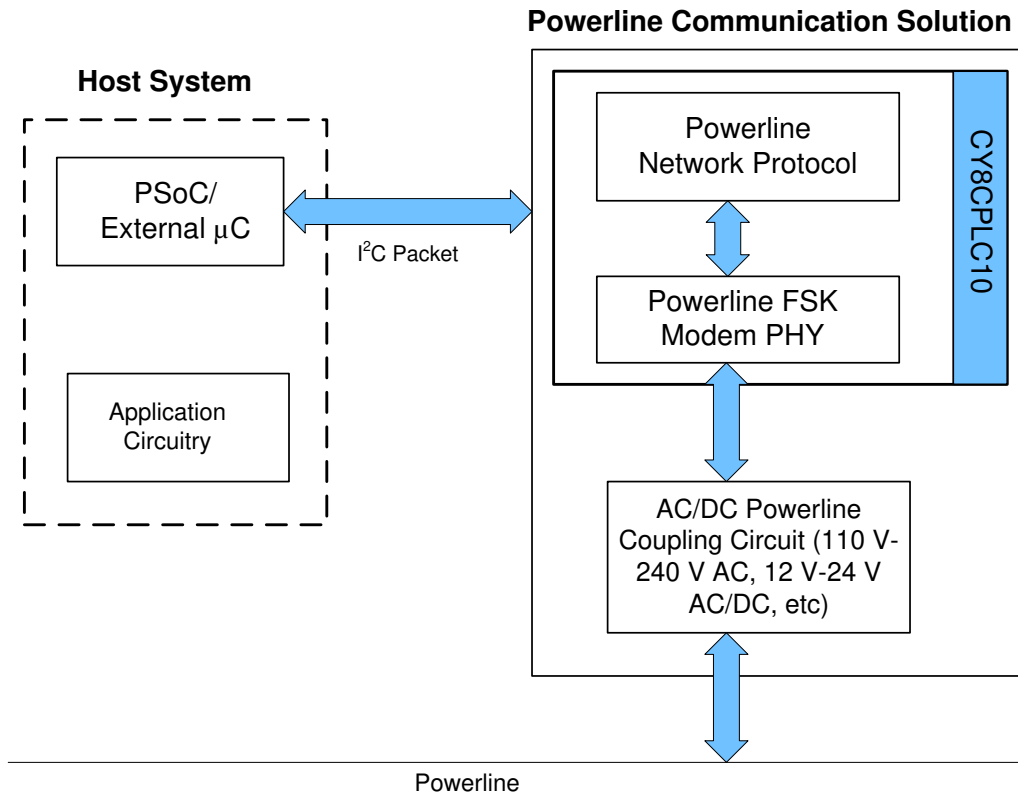

The powerline network protocol layer and physical layer FSK modem are implemented on the CY8CPLC10 device. The power amplification and coupling circuits are built using discrete components. The CY3273 board contains the CY8CPLC10 device along with the power amplification and coupling circuit for communicating on low voltage (12 to 24 V AC/DC) powerlines. For a detailed description of the design parameters for the circuit, refer to application note [Cypress Powerline Communication Board Design Analysis - AN55427](#).

The CY8CPLC10 device is controlled by an external host microcontroller through an I<sup>2</sup>C interface. To evaluate this kit, an external host must be created.

- The first option is to use a PC to install and run the Cypress PLC Control Panel GUI, which is included with this kit. The PC interfaces to the CY3273 board through the [CY3240-I2USB Bridge](#) that is included with this kit. Steps for setting up this system are provided in the quick start guide that is provided in the kit.
- The second option is to use an external microcontroller that runs a host application. The application note, "[AN52478 - Designing an external Host Application for Cypress's Powerline Communication IC CY8CPLC10](#)", provides a code example that can be programmed on a PSoC microcontroller board (in this case, the CY3210-PSoCEVAL1) and explains how to interface it to the CY3273 board. This application note is provided with this kit.

**Note** To evaluate this kit, a second low voltage PLC kit is required. The compatible kits are CY3273 (this kit) and CY3275 Low Voltage PLC Development Kit. For information on these kits, visit <http://www.cypress.com/go/CY3273> and <http://www.cypress.com/go/CY3275>. For details on how to program CY3275 boards with an I2C-PLC interface, refer to appendix A.2 of PLC Control Panel GUI User Guide.

## 1.3 Kit Contents

The PLC LV evaluation kit consists of the following:

- CY3273 quick start guide
- CY3273 PLC LV evaluation board
- Five CY8CPLC10-PVXI samples
- CD containing:
  - CY8CPLC10 data sheet
  - Packet test software – PLC control panel application
  - PLC Control Panel Release Notes
  - CY3273 Release Notes
  - CY3273 evaluation board user guide
  - CY3273 board Altium design project
  - CY3273 board schematics, layout, and BOM
  - Application note – [Designing an external Host Application for Cypress's Powerline Communication IC CY8CPLC10 - AN52478](#)
- 12 V power supply
- Daisy chain cable
- USB-I2C Bridge
- Ribbon cable for I<sup>2</sup>C communication, external reset, and powering external board
- Retractable USB cable

## 1.4 Additional Learning Resources

Visit <http://www.cypress.com/go/plc> for additional learning resources in the form of datasheets, technical reference manuals, and application notes.

- *CY3273 Schematic.pdf*  
<http://www.cypress.com/?rID=38025>
- *CY3273 Board Layout.zip*  
<http://www.cypress.com/?rID=38025>
- CY3273 Kit documentation  
<http://www.cypress.com/go/CY3273>
- For a list of PSoC Designer-related trainings, see  
<http://www.cypress.com/?rID=40543>
- CY8CPLC10 datasheet  
<http://www.cypress.com/?rID=38236>
- For more information regarding PSoC Designer functionality and releases, refer to the user guide and release notes on the PSoC Designer web page:  
[www.cypress.com/go/psocdesigner](http://www.cypress.com/go/psocdesigner)
- For more information regarding PSoC Programmer, supported hardware, and COM layer, go to the PSoC Programmer web page:  
[www.cypress.com/go/psocprogrammer](http://www.cypress.com/go/psocprogrammer)
- Designing an External Host Application for Cypress's Powerline Communication IC CY8CPLC10 - AN52478  
<http://www.cypress.com/?rID=37956>

## 1.5 Additional Requirements

The following Cypress demonstration kit is used in the example applications in this user guide. This kit is available for purchase from <http://www.cypress.com/go/CY3210-PSoCEVAL1>.

### **CY3210-PSoCEval1 Kit**

This PSoC Evaluation Kit features an evaluation board and MiniProg1 programming unit. The evaluation board includes an LCD module, potentiometer, LEDs, and plenty of bread boarding space to meet all your evaluation needs. The MiniProg1 programming unit is also included with the kit. It programs PSoC devices directly on the evaluation board, or on other boards through a 5-pin header. This programming unit is small and compact, and connects to a PC through the USB 2.0 cable that is provided.

The kit includes:

- Evaluation board with LCD module
- MiniProg1 programming unit
- PSoC Designer software CD
- 28-pin CY8C29466-24PXI PDIP PSoC device sample
- USB 2.0 cable
- Getting Started guide



## 1.6 Document Revision History

Table 1-1. Revision History

Revision	PDF Creation Date	Origin of Change	Description of Change
**	08/13/2009	IUS	New kit guide
*A	12/10/2009	RARP	Content updates
*B	16/02/2011	FRE	Added Software Installation, Code Examples, and Technical Reference sections. Added schematic in Section 2.3. Added references to the compatible low voltage PLC kits. Added a reference to the quick start guide for evaluation. Added clarifications to the text throughout.
*C	10/12/2011	ADIY	Removed reference to CY3277 and CY8CLED16P01. Added Getting Started Section

## 1.7 Documentation Conventions

Table 1-2. Document Conventions for Guides

Convention	Usage
Courier New	Displays file locations, user entered text, and source code: C:\...cd\icc\
<i>Italics</i>	Displays file names and reference documentation: Read about the <i>sourcefile.hex</i> file in the <i>PSoC Designer User Guide</i> .
[ <b>Bracketed, Bold</b> ]	Displays keyboard commands in procedures: [ <b>Enter</b> ] or [ <b>Ctrl</b> ] [ <b>C</b> ]
File > Open	Represents menu paths: File > Open > New Project
<b>Bold</b>	Displays commands, menu paths, and icon names in procedures: Click the <b>File</b> icon and then click <b>Open</b> .
Times New Roman	Displays an equation: $2 + 2 = 4$
Text in gray boxes	Describes cautions or unique functionality of the product.



## 2. Getting Started



This chapter describes how to install and configure the CY3273 - LV PLC Evaluation Kit.

### 2.1 Kit Installation

To install the kit software, follow these steps:

1. Insert the kit CD in your PC's CD drive. The CD is designed to auto-run and the **Kit Installer Startup Screen** appears.
2. Click **Install CY3273 Low Voltage PLC Kit** to start the installation.

Figure 2-1. Kit Installer Startup Screen



**Note** If auto-run does not execute, double-click the *cyautorun.exe* file on the root directory of the CD.

Figure 2-2. Root Directory of CD



3. The **CY3273 - LV PLC Evaluation - InstallShield Wizard** screen appears. Choose the folder location to install the setup files. You can change the location of the folder using **Change**.
4. Click **Next** to launch the kit installer.

Figure 2-3. CY3273-LV PLC Evaluation InstallShield Wizard

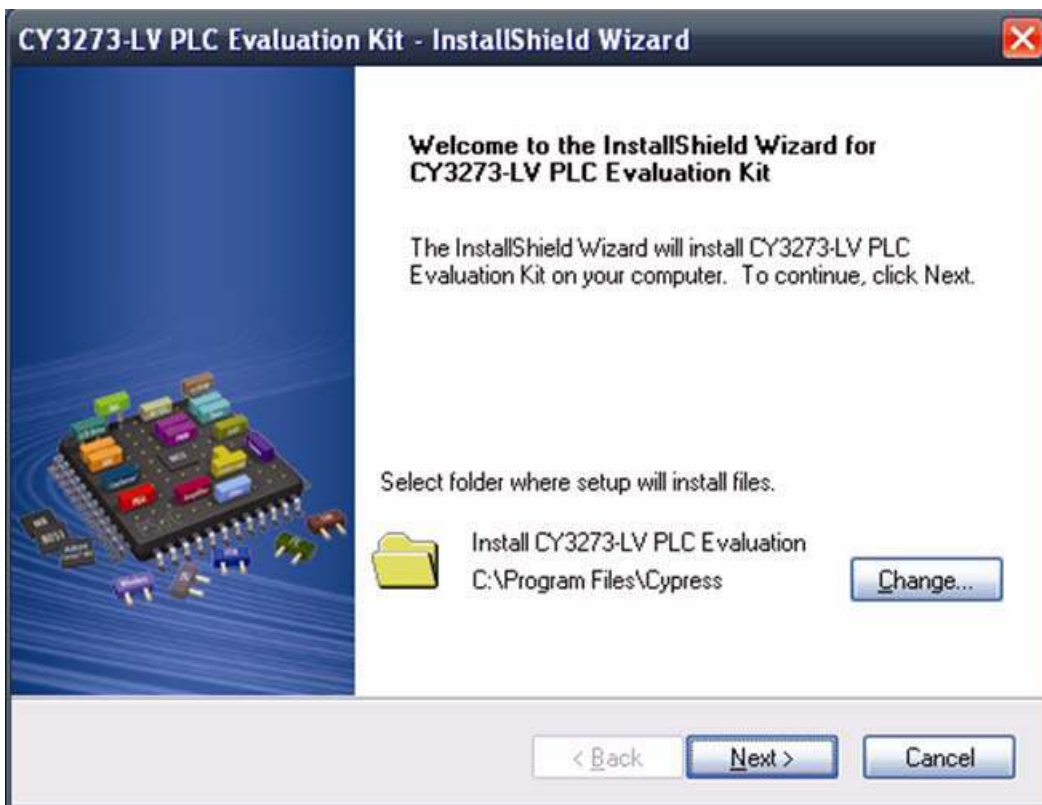



7. When the installation begins, a list of all packages appears on the **Installation Page**.
8. A green check mark appears next to every package that is downloaded and installed.
9. Wait until all the packages are downloaded and installed successfully.

Figure 2-5. Installation Page

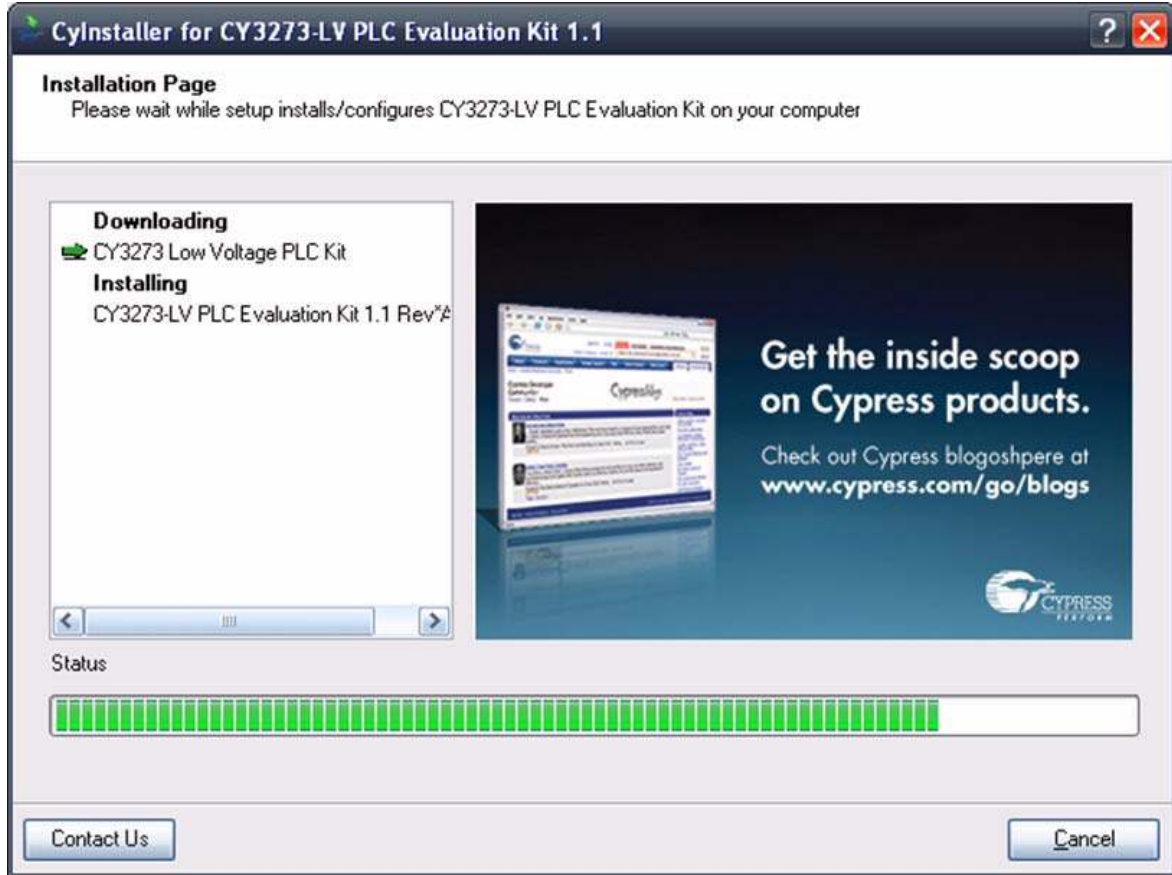

10. Click **Finish** to complete the installation.

Figure 2-6. Installation Completion Page

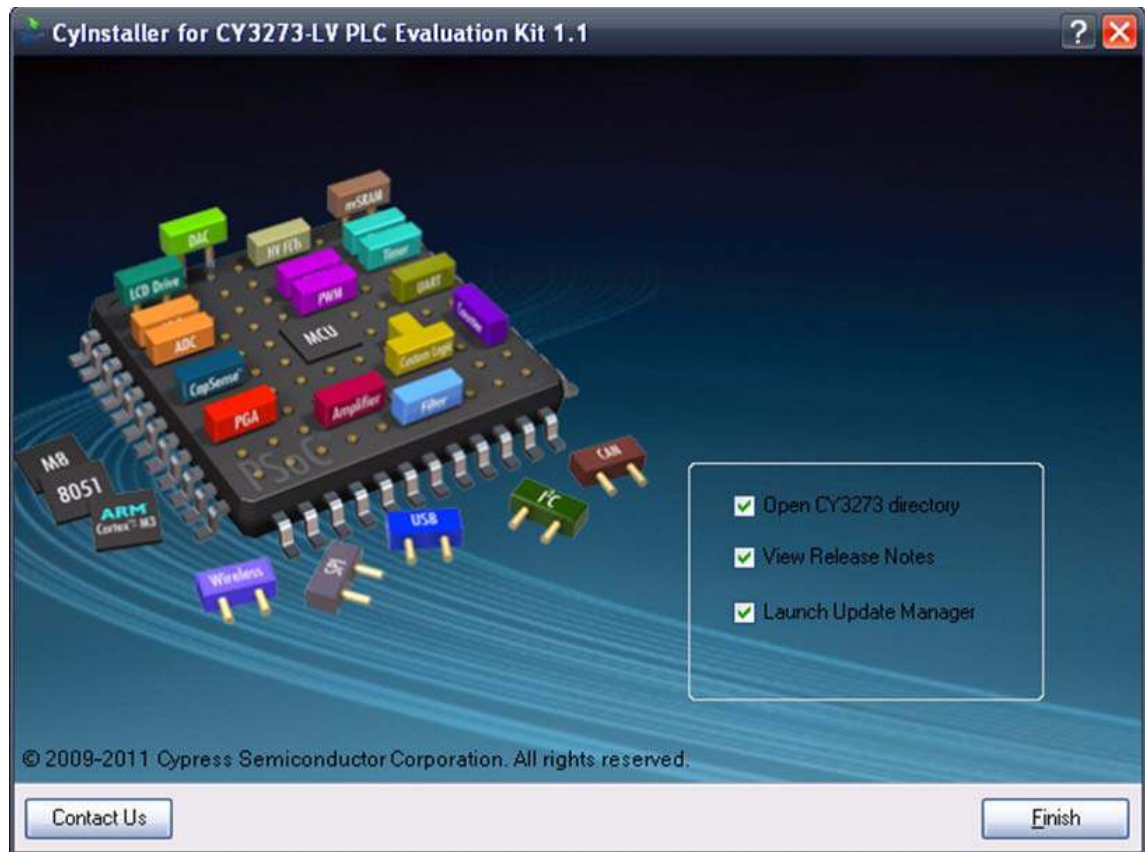

## 2.2 Software Installation

### 2.2.1 Before You Begin

All Cypress software installations require administrator privileges; however, this is not required to run the installed software.

- Shut down any Cypress software that is currently running.
- Disconnect any Cypress devices (USB-I2C bridge, ICE Cube, or MiniProg) from your computer.

### 2.2.2 Prerequisites

The PLC Control Panel requires the latest versions of Microsoft .NET Framework, Adobe Acrobat Reader, and a Windows Installer. If your computer does not have .NET Framework and Windows Installer, the installation automatically installs it. However, if your computer does not have Adobe Acrobat Reader, download and install it from the Adobe website.

### 2.2.3 Installing PLC Control Panel Software

The PLC Control Panel GUI is installed as a prerequisite when you install the CY3273 PLC LV Evaluation kit. Follow the steps on the screen to complete the installation.

If you need to reinstall this application, select **Install PLC Control Panel GUI** from the installation screen, as shown in [Figure 2-1 on page 11](#).

Click **Start > All Programs > Cypress > PLC Control Panel > PLC Control Panel**.

The PLC Control Panel application controls the CY3273 PLC LV Evaluation Kit over USB interface from a PC. The application's startup display, when a board attached and operating, is shown in the following figure.

Figure 2-7. PLC Control Panel Application

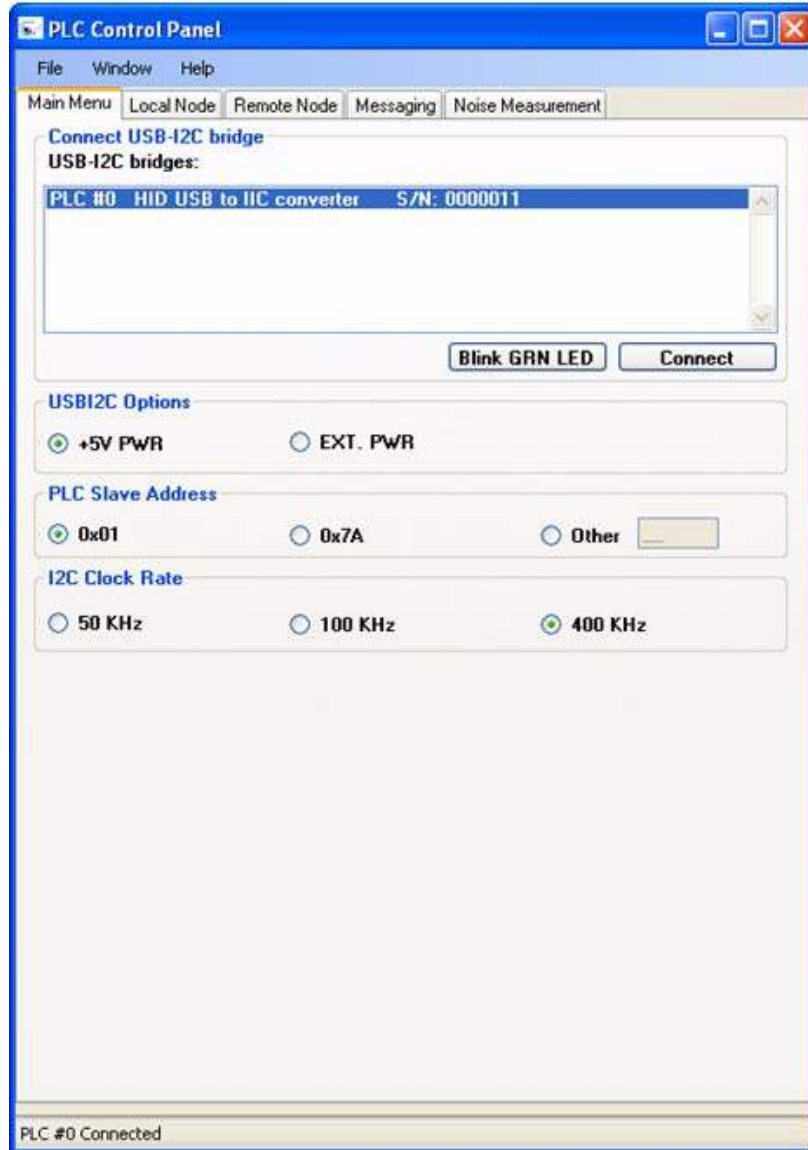

After installing PLC Control Panel, refer to the documentation as needed:

- <CD Drive>\ Software\PLC Control Panel\PLC Control Panel Release Notes.pdf
- <CD Drive>\ Software\PLC Control Panel\ User Guide for Cypress PLC Control Panel GUI.pdf

The PLC Control Panel user guide is also available in the installation directory. It contains information about installation and how to set up the kit to work with the GUI. You can also access it from the Help menu in the PLC Control Panel GUI.



# 3. PLC LV Evaluation Board



## 3.1 Features

The key features of the CY3273 evaluation board are:

- Chip power supply derived from 12 V to 24 V AC/DC
- On-chip powerline network protocol layer and physical layer FSK modem
- LED status indicators for power, powerline transmit and receive, and band in use
- Five-position DIP switches
  - Three DIP switches for node logical address selection
  - One DIP switch to configure node I<sup>2</sup>C addressing mode
  - One DIP switch to select between the external crystal and oscillator
- Integrated powerline modem PHY

## 3.2 Functional Overview

The PLC evaluation board is designed as an advanced evaluation, testing, and product development platform for low bandwidth (2400 bps) powerline communication.

Data to be transmitted is sent to the CY8CPLC10 through the I<sup>2</sup>C serial communications interface from a host microcontroller.

The CY8CPLC10 receives this I<sup>2</sup>C data and encapsulates it into a PLC network packet. The on-board FSK modem modulates this packet and the coupling circuitry incorporates the resulting sinusoidal waveform on to the existing waveform on the high voltage powerline bus.

### 3.2.1 Operating Conditions

- Input voltage: 12/24 V AC/DC
- Input current: 200 mA/150 mA
- Operating temperature: 0 °C to 40 °C
- Operating humidity condition: 5% to 95% relative humidity (RH), non-condensing

### 3.3 Hardware Description

The key sections of the low voltage PLC evaluation board are highlighted in Figure 3-1. The board is divided into four main sections:

- Power supply circuit
- Transmit amplifier
- Transmit and receive coupling circuit section
- Cypress powerline transceiver and user controls

Figure 3-1. Top View of Cypress PLC LV Evaluation Board

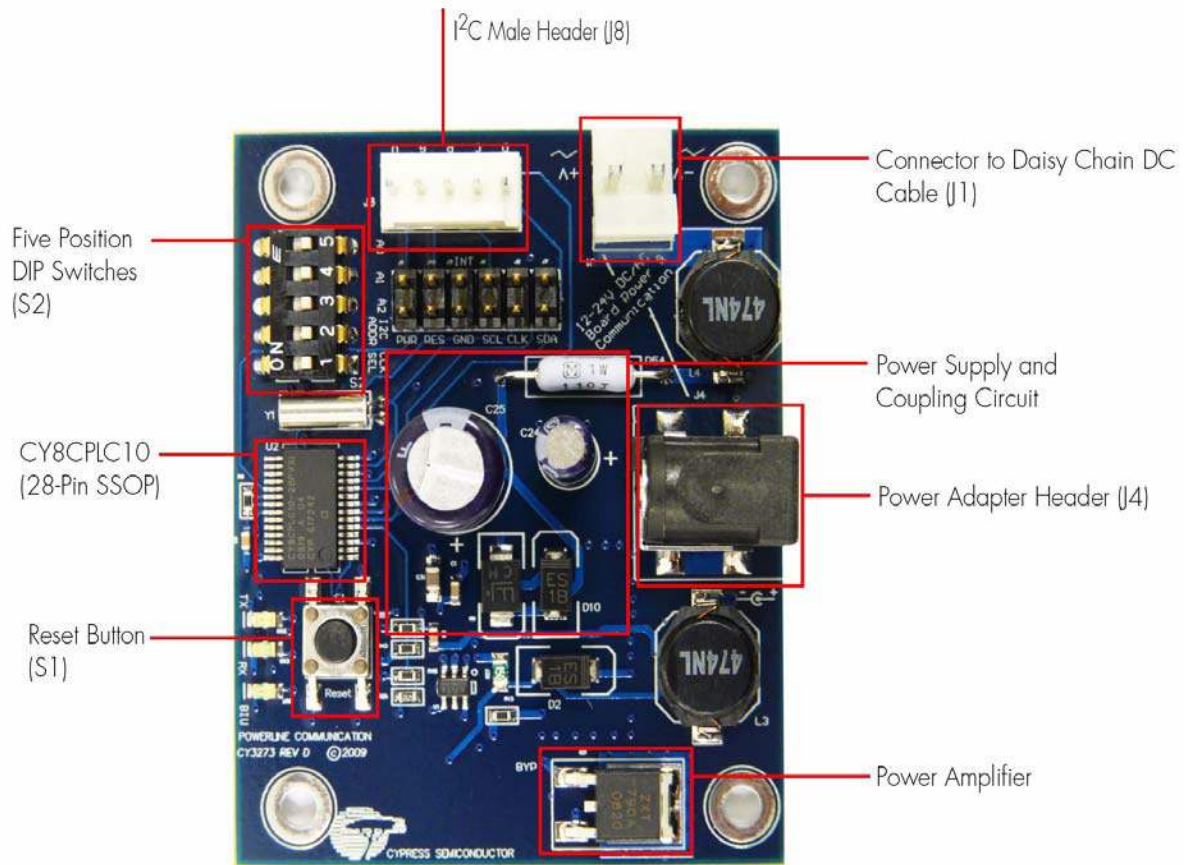

The communication signal flow on this LV board is:

*Transmit:* CY8CPL10 TX Pin → Power Amplifier Circuitry → LV PLC Circuitry → LV Powerline (12 V to 24 V AC/DC)

*Receive:* LV Powerline (12 V to 24 V AC/DC) → LV PLC Circuitry → Passive Low Pass Filtering → VDD/2 Biasing → CY8CPL10 RX Pin

The core of the PLC LV board is the CY8CPL10 chip. The board contains an I<sup>2</sup>C connector, jumpers to control various functions, and a five-position DIP switch.

### 3.3.1 Power Supply Circuit

This section takes the power from the powerline and generates necessary low DC voltage for the operation of the PLC transceiver and other components on the chip.

The key components in this section are listed in the following table.

Table 3-1. Power Supply

Component	Description
J4	This is the connector to hook up the power adapter.
U7	5 V regulator.
J1	This is a 2-pin header to connect other boards in daisy chain and power them. The cable to do this is provided with the kit. Connect a maximum of five boards in one daisy chain.
DS1	This is a blue LED that glows when the board is powered on.
L4	This inductor blocks any high frequency power supply noise from disrupting the line. It also minimizes any effect of loading from the power supply on the PLC signal.

The key components are circled in the following schematic.

Figure 3-2. Power Supply Schematic

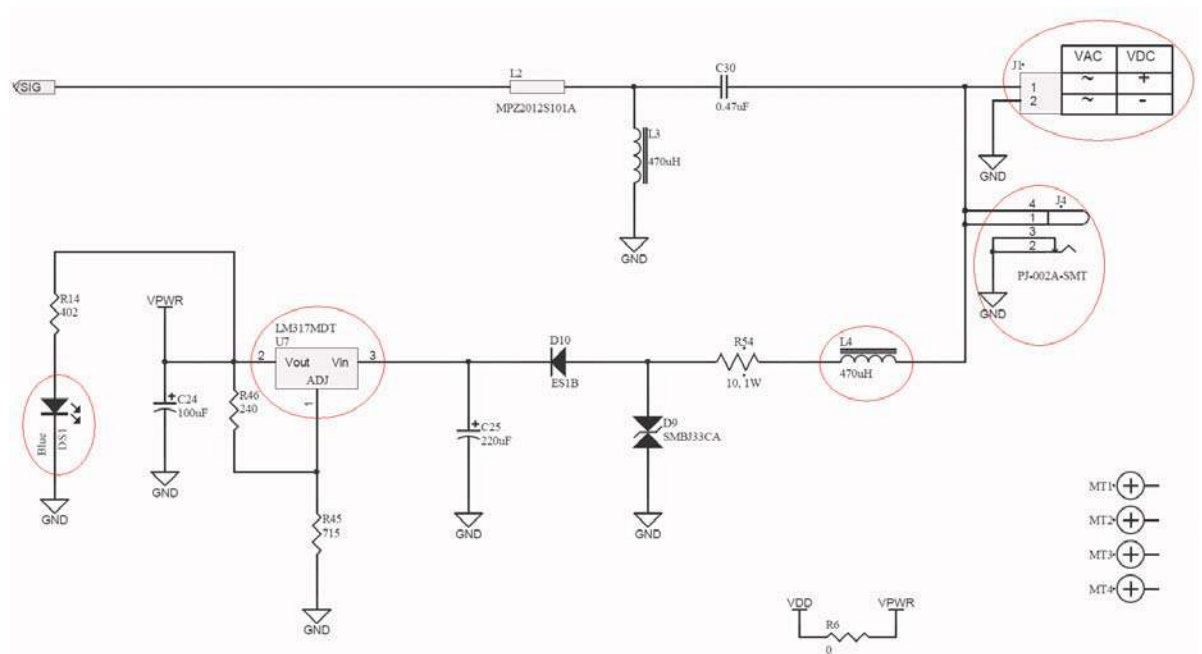

### 3.3.2 Transmit Amplifier Circuit

This section takes the output signal from the transceiver chip. The circuit here amplifies the signal for transmission over the powerline.

The key components in this section are listed in the following table.

Table 3-2. Transmit Amplifier

Component	Description
U1, Q3, Q2	This opamp and high gain transistors are used in the power amplification stage.
Q1	This transistor controls whether transmission is allowed based on the output of the TXDISABLE pin

The key components are circled in the following schematic.

Figure 3-3. Transmit Amplifier Schematic

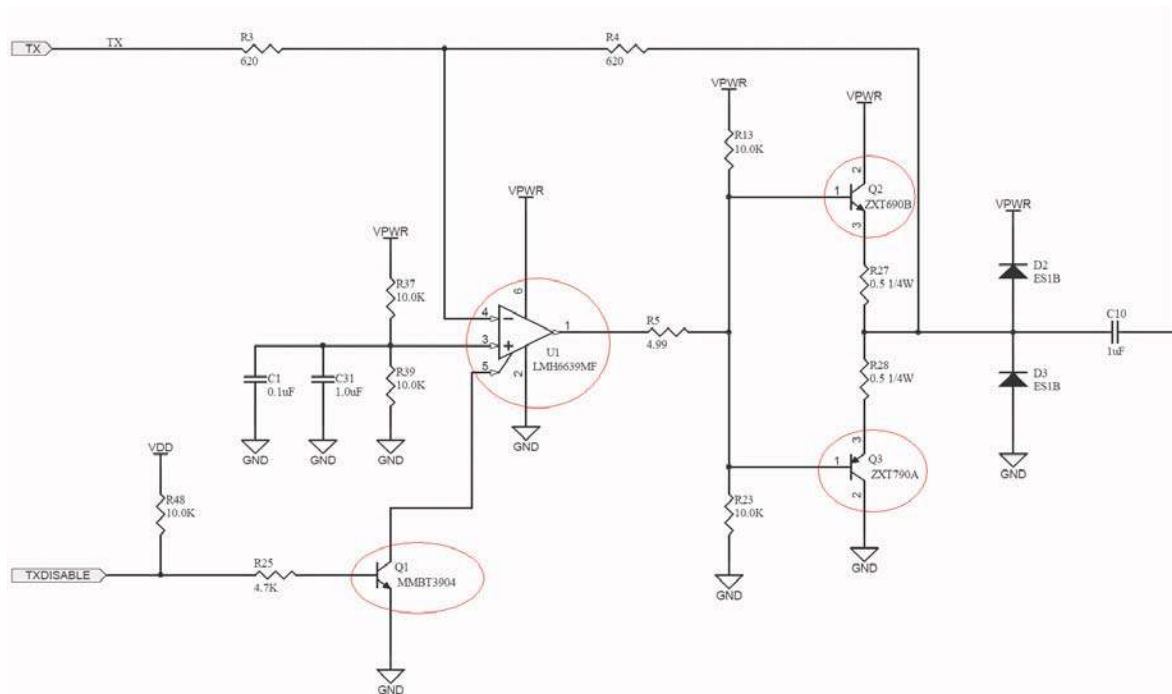

### 3.3.3 Transmit and Receive Coupling Circuit

This circuit couples the signal from the board on to the powerline. On the receive side, the same circuit couples the carrier on the powerline to the board, rejecting the low frequency power and noise on the powerline.

The key components in this section are listed in the following table.

Table 3-3. Transmit and Receive Coupling Circuit

Component	Description
L2	This inductor blocks very high frequency signals (for example, FM radio ) and offsets the impedance of capacitor C30, so as to have a lower transmit impedance.
L3	This inductor, along with C30, filters out low frequency signals (for example, 50/60 Hz AC or DC power) and presents a high impedance to the 132 kHz PLC signal.
C30	This is the coupling capacitor that couples the PLC signal and blocks the low frequency signals. Its voltage rating must be higher than the voltage on the powerline..

The key components are circled in the following schematic.

Figure 3-4. Transmit Amplifier Schematic

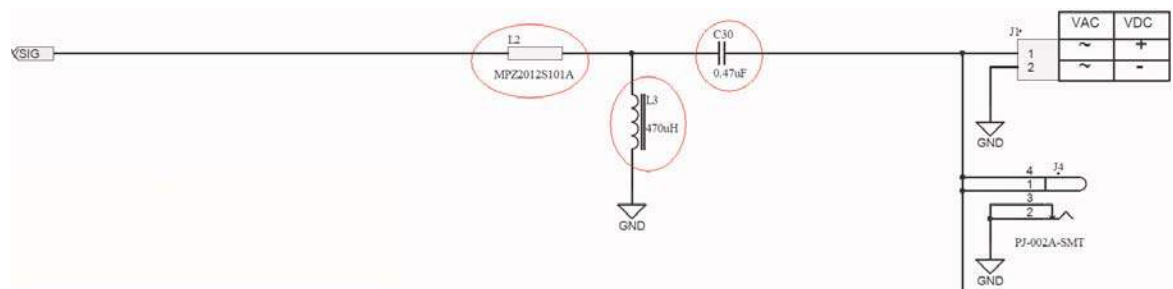

### 3.3.4 Cypress Powerline Communication Transceiver and User Controls

This section is the heart of the board. It has the CY8CPLC10 chip, which has the integrated transceiver modem and network protocol. It also has the I<sup>2</sup>C header to communicate with the external host processor. The DIP switches to control the addresses and the jumpers to control the functionality of the chip are also located here. The red, blue, yellow, and green LEDs indicate the status of the board when functioning. The key components and their use are as follows:

Table 3-4. Transceiver and User Controls

Component	Description
CY8CPLC10	This is Cypress's powerline transceiver device. It is a 28-pin SSOP device.
Tx LED[DS2]	This is a green LED that glows when the board is transmitting data on to the powerline.
Rx LED[DS3]	This is a red LED that glows when the CY8CPLC10 device is receiving data.
BIU LED [DS5]	This is a yellow LED that glows when the transmit frequency band is in use.
S1	Reset switch to reset the CY8CPLC10 device.
S2[3-5]	These dip switches are used to set up the logical address of the node in the network. This is an easy way for you to quickly assign an address from 0 to 7 to the board in a network. S1[3] is MSB and S1[5] is LSB for logical address assignment.
S2[2]	This dip switch sets the I <sup>2</sup> C slave address to establish the communication with a host processor. Setting the switch to OFF or ON sets the I <sup>2</sup> C address to external 0x01 or 0x7a respectively.
S2[1]	This dip switch controls the clock setting to the CY8CPLC10. Setting the switch to 0 or 1 sets the FSK modem clock to external 32 kHz crystal or external 24 MHz oscillator, respectively. Note that the external crystal is always required for protocol timing.
Y1	This 32.768 kHz crystal is required for establishing the correct protocol timing and communication signal frequencies of the CY8CPLC10.

The key components are circled in the following schematic.

Figure 3-5. Transmit Amplifier Schematic

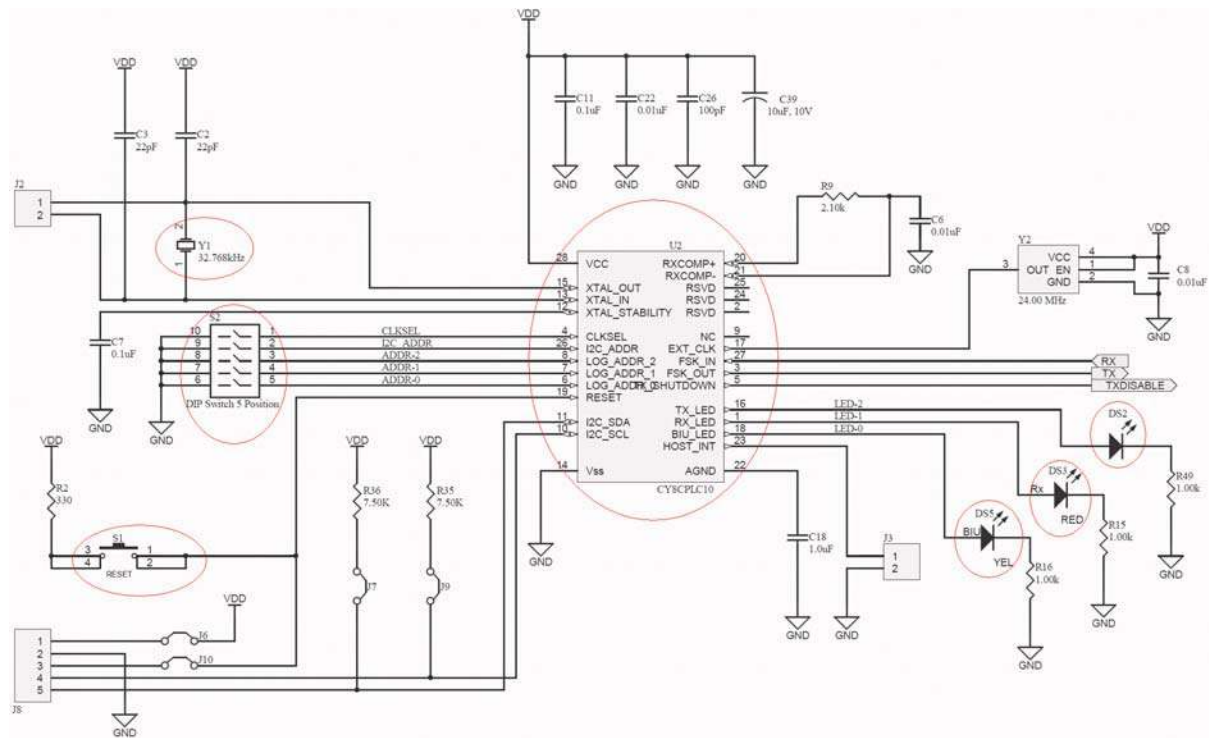

### 3.4 Setting Up the PLC LV Board

This section describes the components of the PLC evaluation board, the process of setting manual addresses on the PLC LV board and the connection of USB-I2C Bridge and I<sup>2</sup>C cable to the I<sup>2</sup>C header on the board.

#### 3.4.1 I<sup>2</sup>C Header Settings

J8 is a five-pin header that can be used for communicating with an external board, powering an external board, and resetting the CY8CPLC10 device from an external board. A five wire ribbon cable provided with the CY3273 kit can be used to connect to J8. The following table describes the J8 header pins.

Table 3-5. J8 I2C Header Pins

J8 Pin Name	Description
V – Vdd	The V <sub>DD</sub> pin can provide a maximum of 50 mA at 5 V to an external board. It is only to source the current. Do not supply power to this pin for powering the CY8CPLC10 device. Note that the PWR jumper, as explained in the next section, needs to be connected to enable this functionality.
G – Gnd	The Gnd pin can provide the ground reference to an external board. This pin connects to the ground of the CY3273 board.
D – I2C Data (SDA)	The I <sup>2</sup> C data (SDA) pin is the data line for the I <sup>2</sup> C communication. This pin is directly connected to the I2C_SDA pin on the CY8CPLC10 device. Check the next section for appropriate jumper settings for I <sup>2</sup> C communication through this pin.
C – I2C Clock (SCL)	The I <sup>2</sup> C clock (SCL) pin is the clock line for the I <sup>2</sup> C communication. This pin is directly connected to the I2C_SCL pin on the CY8CPLC10 device. Check the next section for appropriate jumper settings for I <sup>2</sup> C communication through this pin.
R – Reset	Connecting the reset of an external board to this pin enables the resetting of the CY8CPLC10 device through the external board. Note that the RES jumper, as explained in the next section, must be connected to enable this functionality.

Figure 3-6. I<sup>2</sup>C Header for Communication

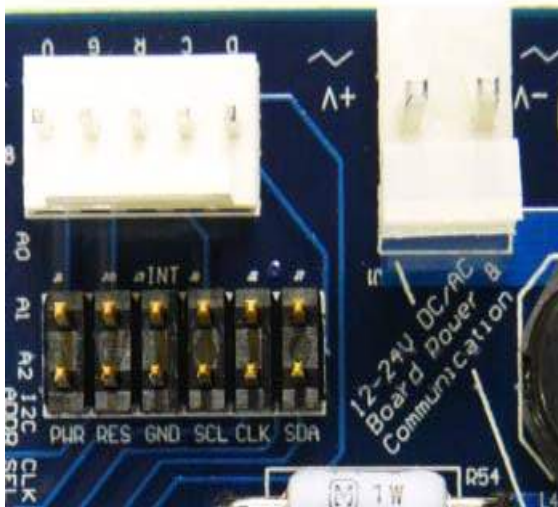

### 3.4.2 Setting Up Manual Addressing on PLC Boards

The PLC evaluation board contains a five-position DIP switch. The first three switches S2[3-5] are used to manually set a logical address for the PLC chip. Logical addresses for up to eight nodes can be set up using these DIP switches.

S2[3] is the MSB. S2[5] is the LSB. Set the DIP switch to the ON position for the particular bit to be logic '1' and OFF position for it to be logic '0'. For example, for setting the logical address of 0X06 (see [Figure 3-7](#)):

S2[5] → OFF = 0

S2[4] → ON = 1

S2[3] → ON = 1



Figure 3-7. DIP Switches for Manual Addressing on the PLC Evaluation Boards

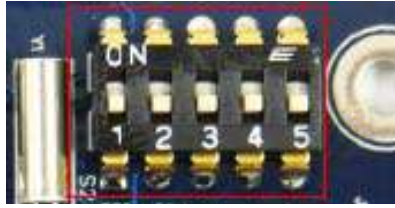

Note that the powerline network protocol supports 8-bit logical addressing, 16-bit extended logical addressing, and 64-bit physical addressing; all of these are supported through software. An external host or PSoC microcontroller can talk to the CY8CPLC10 internal memory map to set the appropriate mode and write a particular logical address.

Manual addressing is an easy method to quickly assign a particular address between 0 and 7 to the board, which may be a node in a network.

**Note** After changing the address of the node, press the RESET button on the PLC LV board for the change to take effect.

### 3.4.3 Setting Up the I<sup>2</sup>C Address of the Node

S2[1] dip switch is used to assign a specific I<sup>2</sup>C address to the node to communicate with the external microcontroller/PSoC or USB-I2C bridge. When the S2[1] switch is in the OFF position, the address of the node is 0x01 and when the position is ON, the address of the node is 0x7A. For further details on I<sup>2</sup>C addressing, refer to the data sheet available on the CD.

### 3.4.4 Jumper Settings for the PLC LV Boards

Figure 3-8. Six Jumpers Available on Board



Table 3-6. Jumper Description

Jumper Name	Use
INT	This is not a jumper. It is a 2-pin header to connect the interrupt pin of the CY8CPLC10 device to an external host. Refer to the CY3273 board schematics to determine interrupt and ground pins for this header.
PWR	This jumper should be connected if the user wants to provide power to an external board. After this jumper is connected, power for the external board can be derived from the V (V <sub>DD</sub> ) and G (Gnd) connectors on the I <sup>2</sup> C header (J5). For example, if we connect another PSoC EVAL1 board with this board, the PLC board can supply power to that board too. The CY3273 board can provide a maximum of 50 mA at 5 V to an external board through the V and G pins on the I <sup>2</sup> C header (J5).
RES	This jumper is for enabling reset of the PLC device through an external board. After this jumper is connected, the external board reset can be connected to the R (Reset) pin on the I <sup>2</sup> C header (J8).
SCL	This is a pull up jumper. While communicating through I <sup>2</sup> C (J8), one side has to pull up the line. When the jumper is connected, the SCL line gets pulled high. This needs to be done when the user wants the I <sup>2</sup> C link to be pulled up by the CY3273 board. This jumper does not need to be placed if the USB-I2C bridge is used for communication to the host.
SDA	This is a pull up jumper. While communicating through I <sup>2</sup> C (J8), one side has to pull up the line. When the jumper is connected, the SDA line is pulled high. This must be done when the user wants the I <sup>2</sup> C link to be pulled up by the CY3273 board. This jumper does not need to be placed if the USB-I2C bridge is used for communication to the host.
CLK	This jumper is not available for use and should be left unconnected by the user.

### 3.5 Code Example

The CY3273 kit is designed for systems that require a communication interface over low voltage powerlines. Typically, these systems consist of a microcontroller or processor along with other electronic components that implement the host application functionality. For more information on this interface, refer to [AN52478 - Designing an External Host Application for Cypress's Powerline Communication IC CY8CPLC10](#).

### 3.6 Technical Reference

For a real-time list of knowledge base articles for the CY3273 kit, refer to our [Online Knowledge Base](#). For any help with the installation of the Control Panel, refer to the Control Panel User Guide provided in the kit CD. You can also download the latest revision of the GUI setup and user guide from [www.cypress.com/go/plc](http://www.cypress.com/go/plc).

# A. Appendix



## A.1 Schematics

### A.1.1 Board Overview

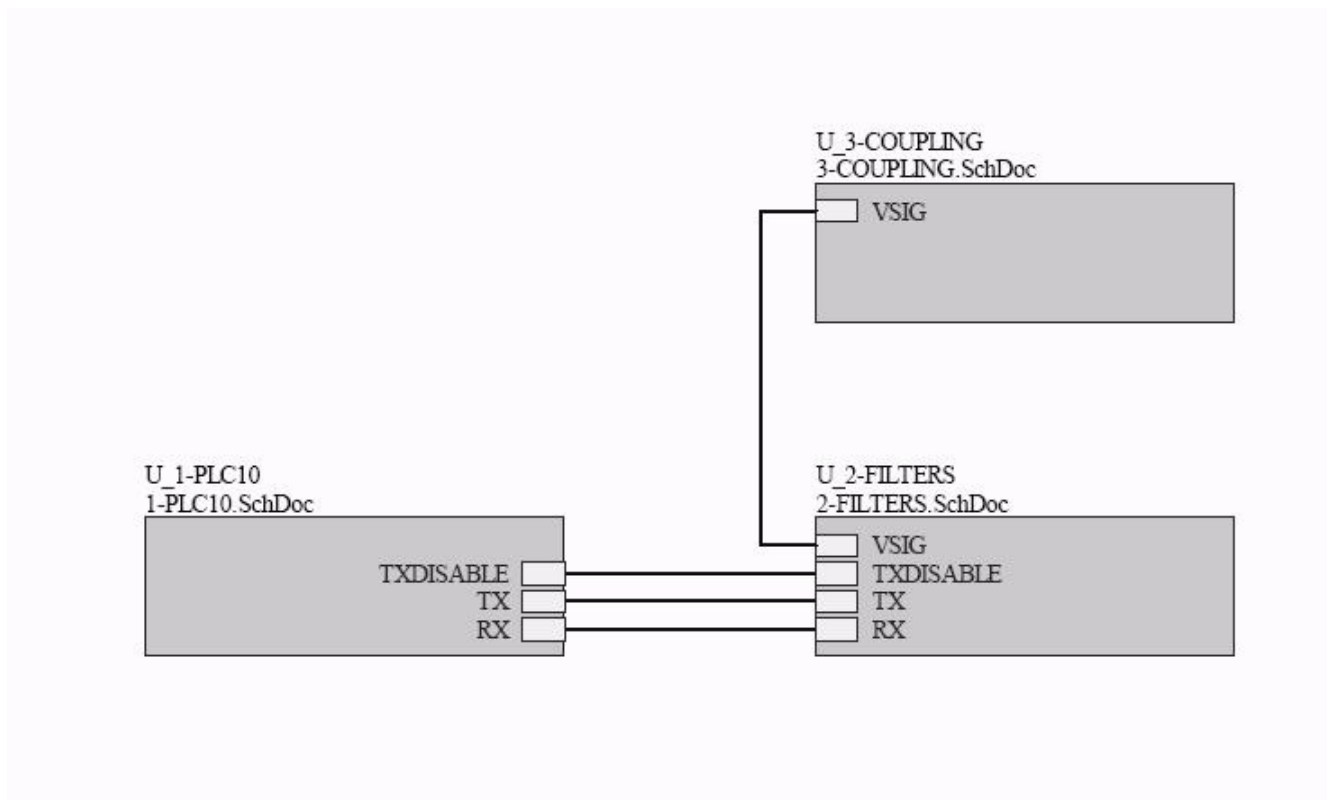

## A.1.2 User Interface

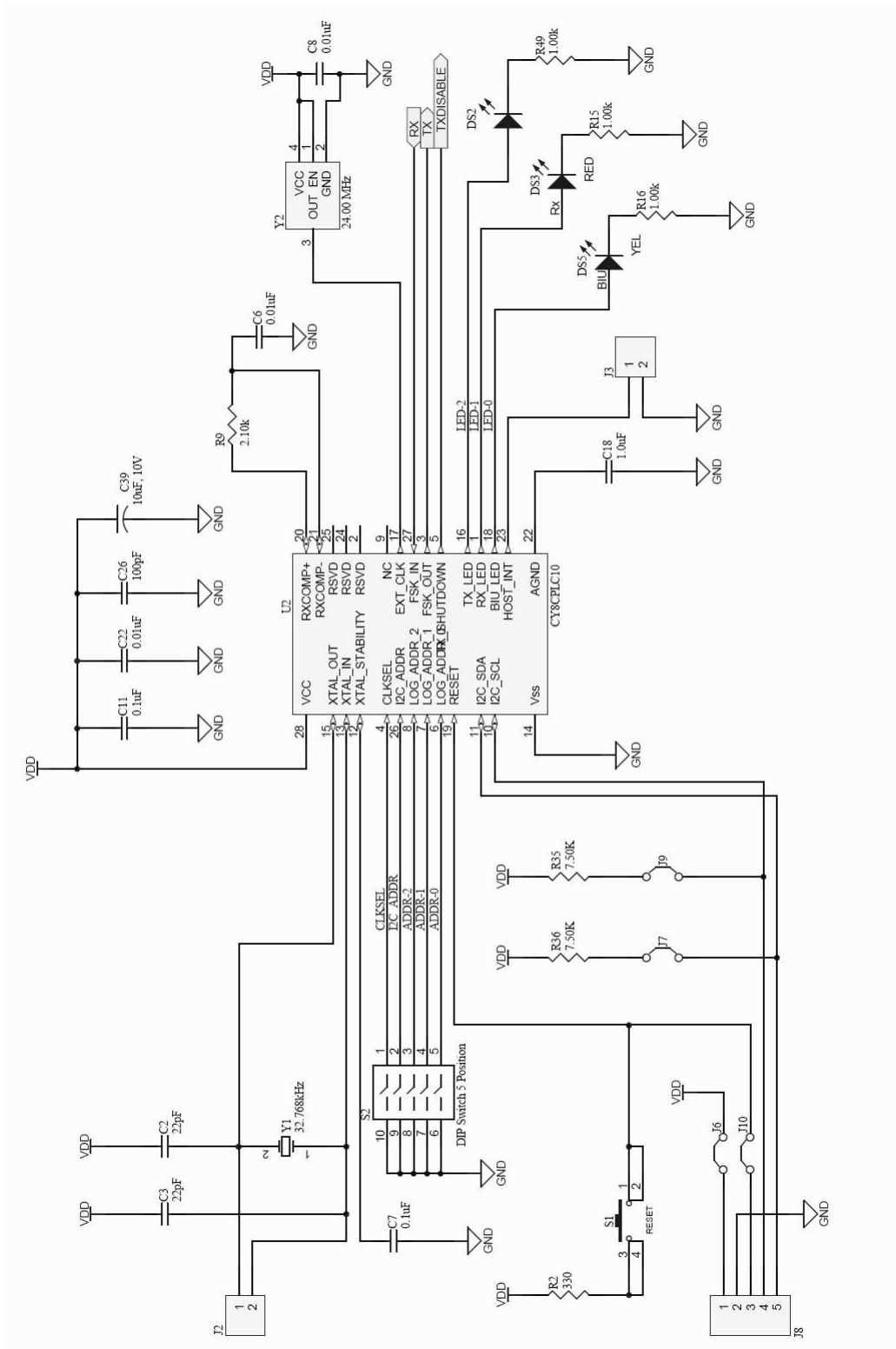

### A.1.3 Transmit Amplification and Receive Filter

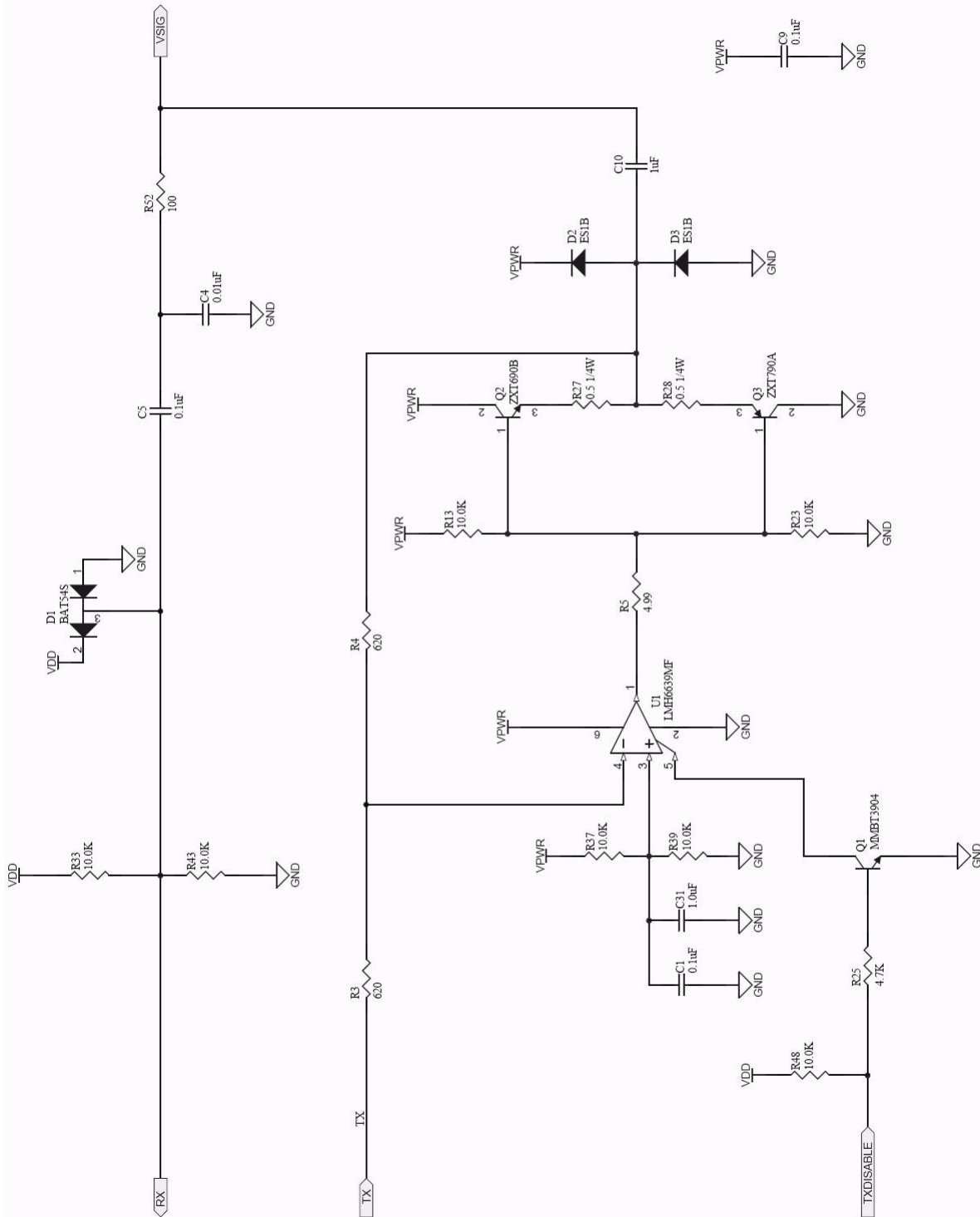



## A.2 Layout

### A.2.1 Top Layer

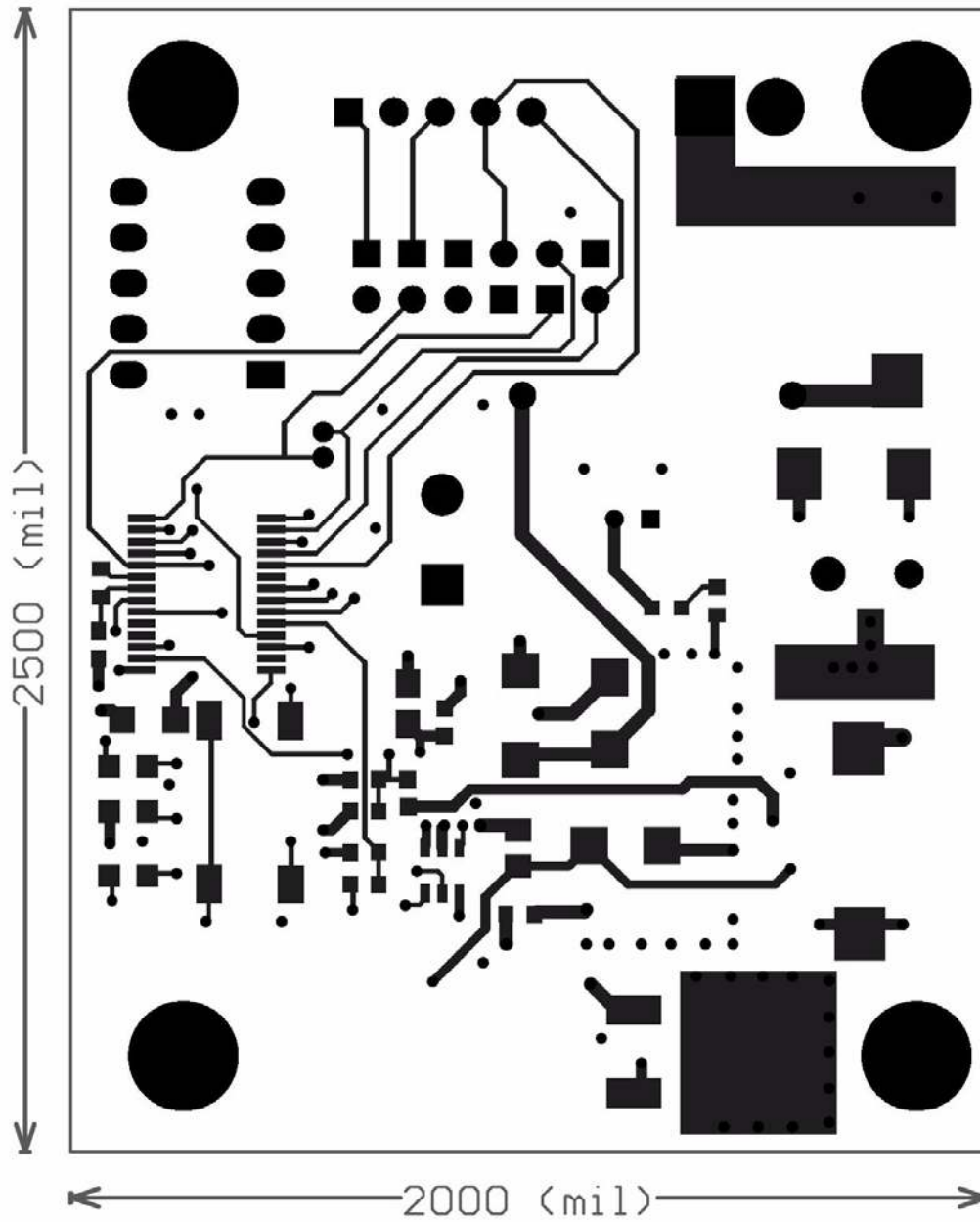

A.2.2 Ground Layer

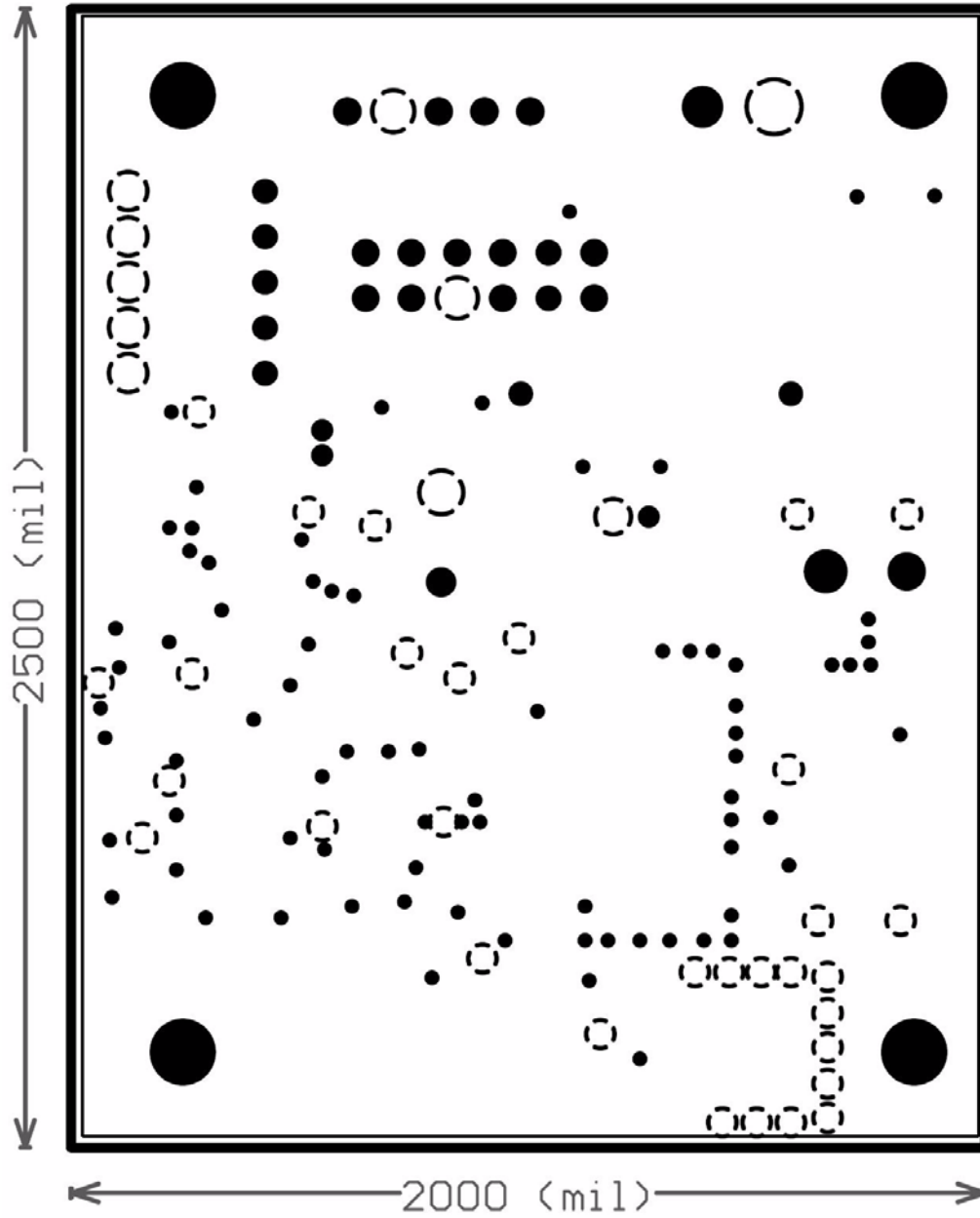



### A.2.3 Power Layer

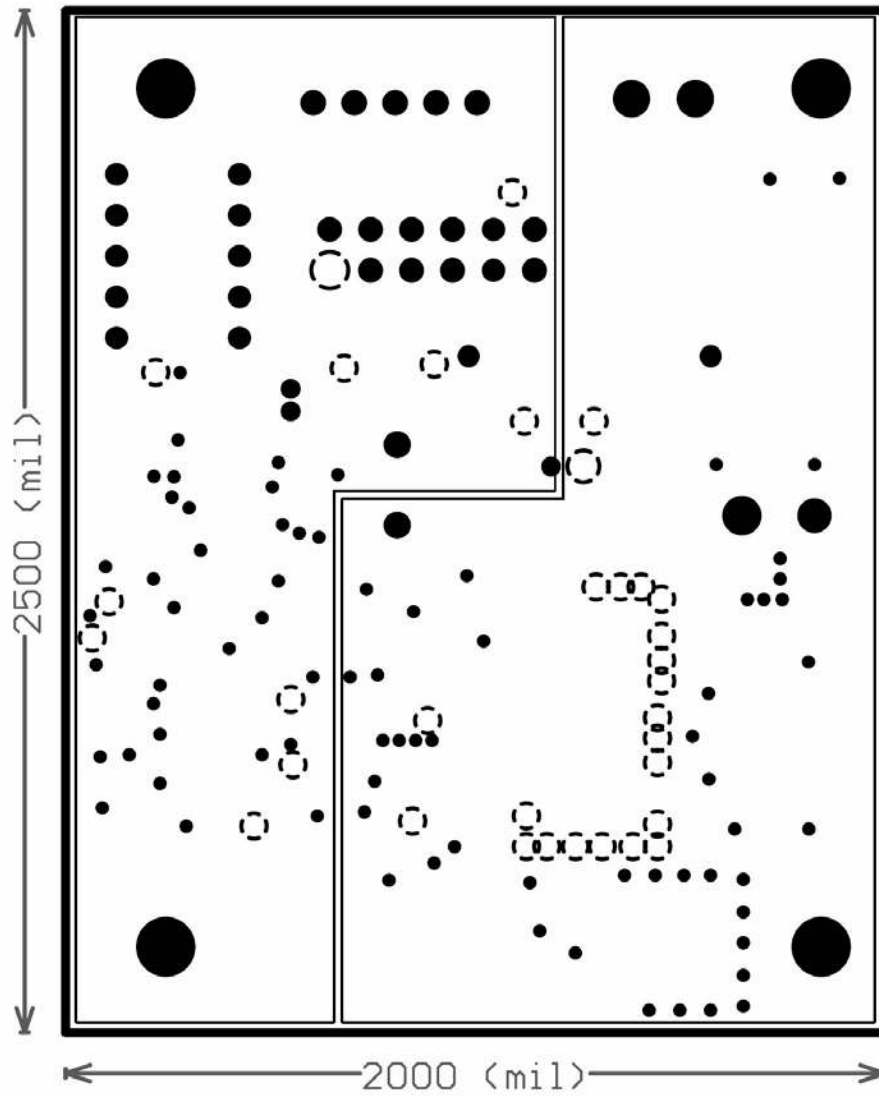

### A.2.4 Bottom Layer

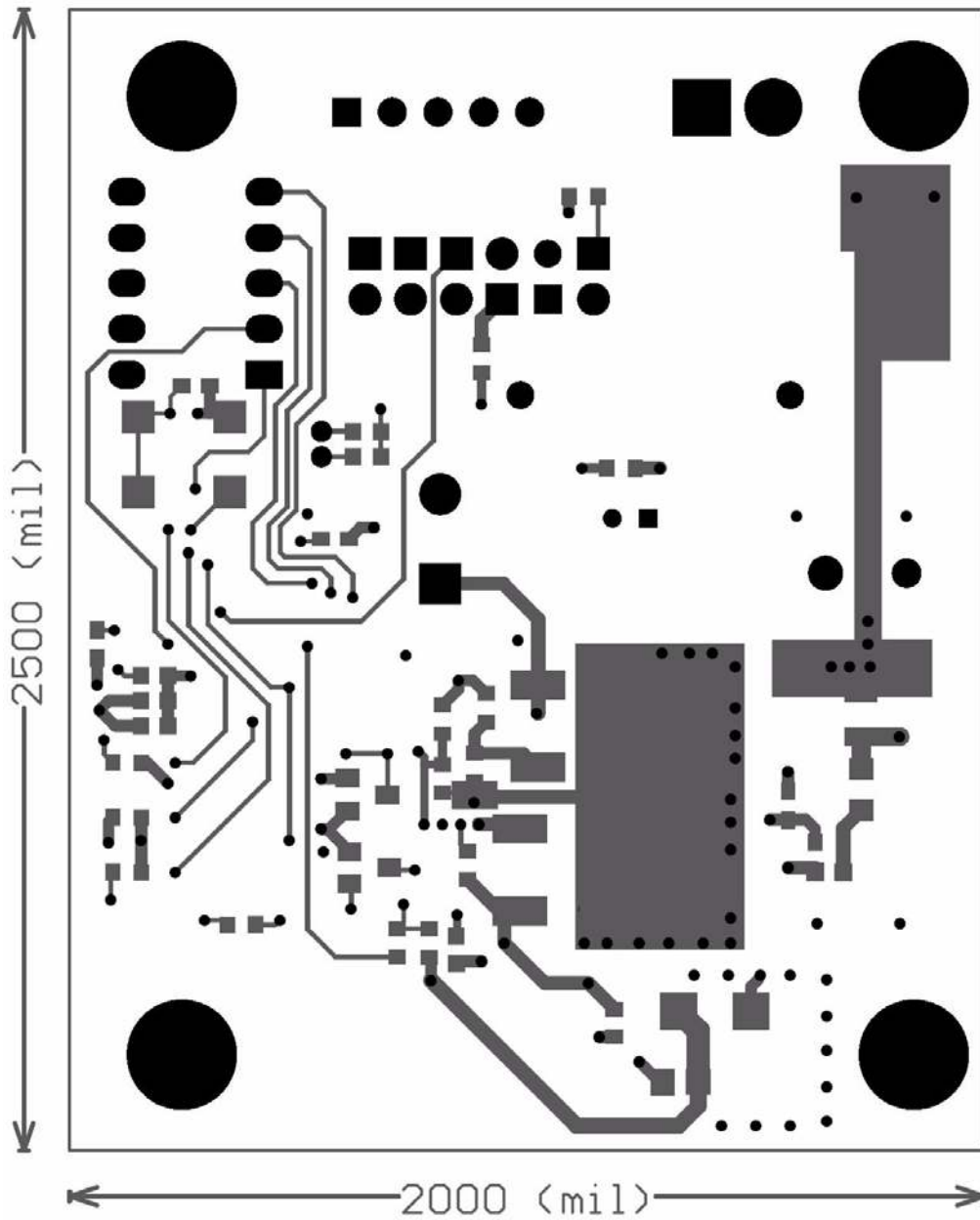

### A.2.5 Top Silkscreen

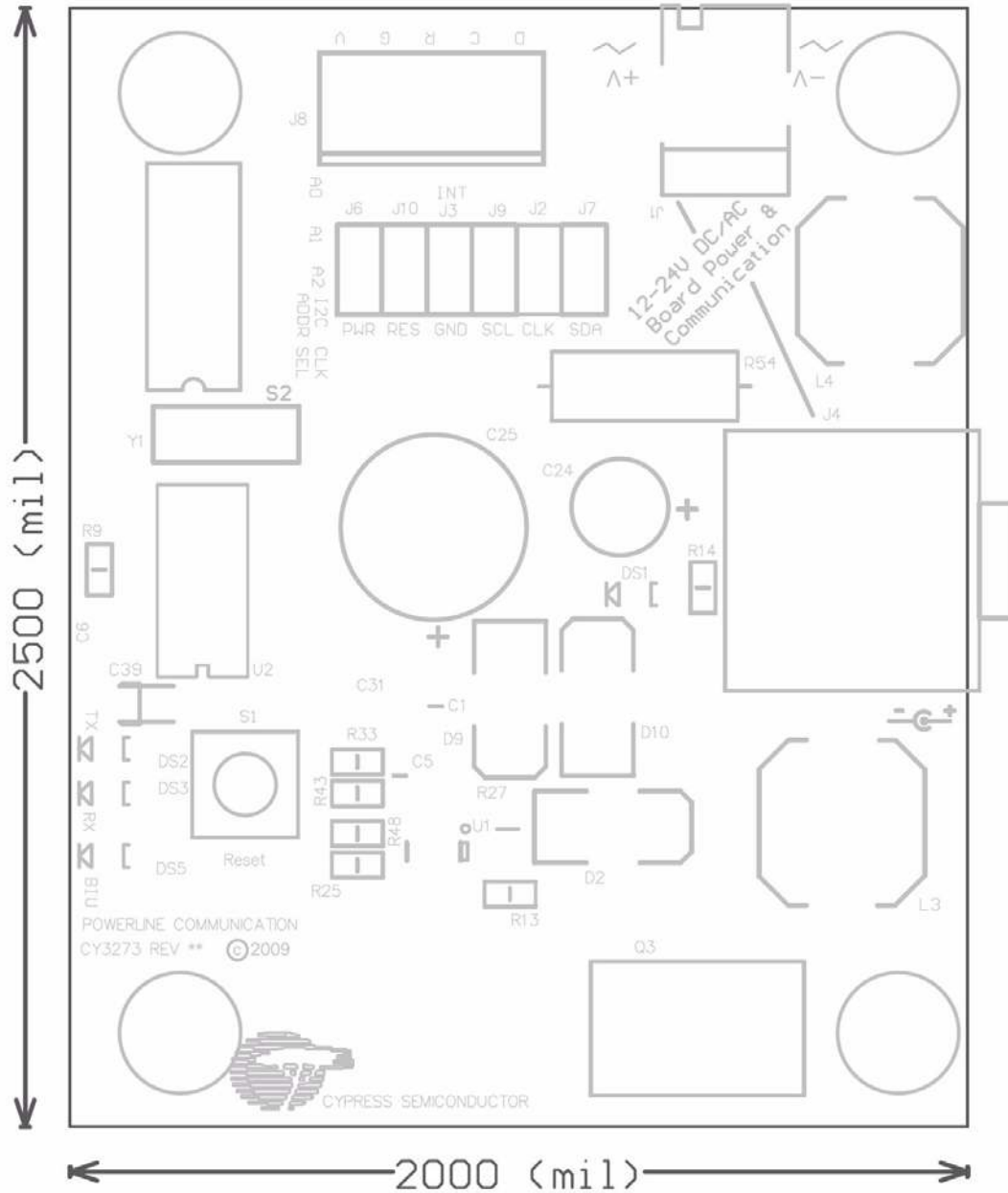

### A.2.6 Bottom Silkscreen

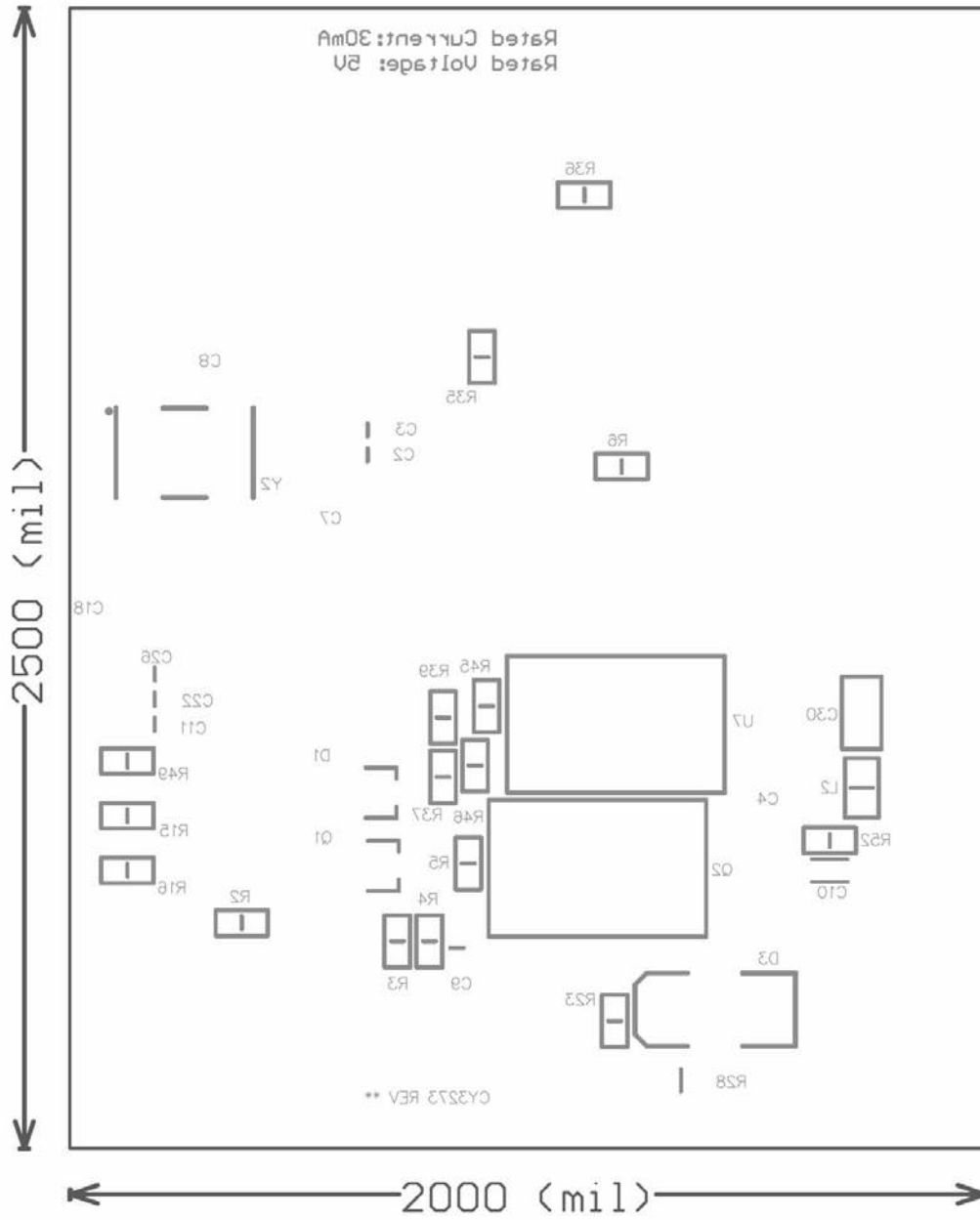

## A.3 Bill of Materials

Description	Designator	Qty	Value	Manufacturer	Manufacturer Part#	Digi-Key#
CAPACITOR, CERAMIC, .1UF, 25V, 5%, X7R, 0603, SMD	C1, C5, C7, C9, C11	5	.1UF	AVX	06033C104JAT2A	478-3713-1-ND
CAPACITOR, CERAMIC, 22PF, 100V, 5%, C0G, 0603, SMD	C2, C3	2	22PF	MURATA	GRM1885C2A220J A01D	490-1335-1-ND
CAPACITOR, CERAMIC, .01UF, 25V, 5%, N0G, 0603, SMD	C4, C6, C22	3	.01UF	TDK	C1608C0G1E103J	445-2664-1-ND
CAPACITOR, CERAMIC, .01UF, 25V X7R 0603	C8	1	0.01uF	AVX	06033C103JAT2A	06033C103JAT2A-ND
CAPACITOR CERAMIC 1UF 16V X7R 0603	C10	1	1UF	PANASONIC	GRM188R71C105K A12D	490-3900-1-ND
CAPACITOR, CERAMIC, 1.0UF, 25V, 20%, X5S, 0603, SMD	C18	1	1UF	PANASONIC	ECJ-1V41E105M	PCC2354CT-ND
CAP 100UF 10V ALUM ELECTRO-LYTIC RADIAL	C24	1	100uF	PANASONIC	ECA-1AM101	P5123-ND
CAPACITOR, ELECTROLYTIC, RADIAL, 220UFD, 50VDC, 20%	C25	1	220UF	PANASONIC	ECA-1HM221	P5183-ND
CAPACITOR, CERAMIC, 100PF, 100V, 5%, C0G, 0603, SMD	C26	1	100PF	AVX	06031A101JAT2A	478-1146-1-ND
CAP CER .47UF 50V X7R 1206 T/R	C30	1	0.47UF	TDK	C3216X7R1H474K	445-1380-1-ND
CAPACITOR, CERAMIC, 1UF, 50V, 20%, Y5V, 0805, SMD	C31	1	1UF	MURATA	GRM21BF51H105Z A12L	490-3903-1-ND
Capacitor 10uF,10V	C39	1	10uF, 10V	Vishay	293D106X9010A2T E3	718-1121-1-ND
DUAL DIODE, W/ SERIES CONN., SCHOTTKY, 30V, 300MA	D1	1	BAT54S	STMICRO	BAT54SFILM	497-2522-1-ND
RECTIFIER, ES1B, ULTRAFast, 100V, 1A	D2, D3, D10	3	ES1B	DIODES INC.	ES1B	ES1B-FDICT-ND
TVS, BI-DIR., 44V, 600W, SMB	D9	1	SMBJ33CA	LITTELFUSE	SMBJ33CA	SMBJ33CALFCT-ND
LED, BLUE CLEAR, 470NM, 0603 SMD	DS1	1	BLUE	ROHM	SML-E12BC7TT86	511-1589-1-ND

Description	Designator	Qty	Value	Manufacturer	Manufacturer Part#	Digi-Key#
LED, CLEAR GREEN, SMD, 2012 (0805)	DS2	1	GRN	LITE-ON	LTST-C170KGKT	160-1414-1-ND
LED, SUPER RED CLEAR, SMD, 2012 (0805)	DS3	1	RED	LITE-ON	LTST-C170KRKT	160-1415-1-ND
LED, CLEAR YELLOW, SMD, 2012 (0805)	DS5	1	YEL	LITE-ON	LTST-C170KSKT	160-1416-1-ND
CONN HEADER 2POS 3.96MM VERT TIN	J1	1		MOLEX	09-65-2028	WM18823-ND
HEADER, 2-pin	J2	1	2 POS	SULLINS	PEC02SAAN	S1012E-02-ND
HEADER, 2-pin	J3, J6, J7, J9, J10	5	2 POS	SULLINS	PEC02SAAN	S1012E-02-ND
POWER JACK, 2.5X5.5MM, MALE, CLOSED, SMD	J4	1	JACK	CUI INC	PJ-002A-SMT	CP-002APJCT-ND
CONN HEADER VERT 5POS .100 TIN	J8	1	5 POS	AMP/TYCO	640456-5	A19471-ND
FERRITE BEAD, EMI FILTER, 100 OHM, 4A, 0805	L2	1	100	TDK	MPZ2012S101A	445-1567-1-ND
INDUCTOR, PWR, 470UH, 20%, DCR=1.460, 0.5A, SMD	L3	1	470UH	PULSE	P0752.474NLT	553-1071-1-ND
INDUCTOR, PWR, 470UH, 20%, DCR=1.460, 0.5A, SMD	L4	1	470UH	PULSE	P0752.474NLT	553-1071-1-ND
MOUNTING HOLES	MT1, MT2, MT3, MT4	4				
NPN, GEN., 40V, .2A, .225W, SOT23	Q1	1	MMBT3904	INFINEON	MMBT3904LT1	MMBT3904LT1INCT-ND
NPN, LO-SAT, 45V, 3A, DPAK	Q2	1	ZXT690BK	ZETEX	ZXT690BKTC	ZXT690BKCT-ND
PNP, LO-SAT, 40V, 3A, DPAK	Q3	1	ZXT790AK	ZETEX	ZXT790AK	ZXT790AKCT-ND
RESISTOR, 330, 1%, 1/10W, 0603 SMD	R2	1	330	YAGEO	RC0603FR-07330RL	311-330HRCT-ND
RESISTOR, 620, 0603, 1%, 1/10W, SMD	R3, R4	2	620	ROHM	MCR03EZPFX6200	RHM620HCT-ND
RESISTOR, 4.99, 0603, 1%, 1/10W, SMD	R5	1	4.99	YAGEO	RC0603FR-074R99L	311-4.99HRCT-ND
RESISTOR, 0.0, 5% , 1/10W, 0603 SMD	R6	1	0.0	ROHM	MCR03EZPJ000	RHM0.0GCT-ND

Description	Designator	Qty	Value	Manufacturer	Manufacturer Part#	Digi-Key#
RESISTOR, 2.1k, 5% , 1/10W, 0603 SMD	R9	1	2.1k	Rohm	MCR03EZPF2101	RHM2.10KHCT-ND
RESISTOR, 10.0K, 1%, 1/10W, 0603 SMD	R13, R23, R33, R43, R48	5	10K	ROHM	MCR03EZPF1002	RHM10.0KHCT-ND
RESISTOR, 402, 0603, 1%, 1/10W, SMD	R14	1	402	ROHM	MCR03EZPF4020	RHM402HCT-ND
RESISTOR, 1.00K, 1%, 1/10W, 0603 SMD	R15, R16, R49	3	1.00K	ROHM	MCR03EZPF1001	RHM1.00KHCT-ND
RESISTOR 4.70K, 1/10W 1% 0603, SMD	R25	1	4.7K	YAGEO	RC0603FR-074K7L	311-4.70KHRCT-ND
RESISTOR, 0.5, 1%, 1/4W, 2012 (0805), SMD	R27, R28	2	0.5	SUSUMU	RL1220S-R50-F	RL12S.50FCT-ND
RESISTOR, 7.50K, 0603, 1%, 1/10W, SMD	R35, R36	2	7.50K	ROHM	MCR03EZPF7501	RHM7.50KHCT-ND
RESISTOR, 10K, 1%, 1/10W, 0603 SMD	R37, R39	2	10K	ROHM	MCR03EZPF1002	RHM10.0KHCT-ND
RESISTOR, 715, 1%, 1/10W, 0603 SMD	R45	1	715	ROHM	MCR03EZPF7150	RHM715HCT-ND
RESISTOR, 240, 0603, 1%, 1/10W, SMD	R46	1	240	ROHM	MCR03EZPF2400	RHM240HCT-ND
RESISTOR, 100.0, 0603, 1%, 1/10W, SMD	R52	1	100	ROHM	MCR03EZPF1000	RHM100HCT-ND
RESISTOR, 10 OHM 1W 5% METAL OXIDE	R54	1	10 Ohm, 1W	Stackpole	RSMF 1 10 5% R	RSMF110JRCT-ND
PUSH BUTTON, NO, LIGHT TOUCH, 6MM, 160G FORCE, SMD	S1	1	N.O.	E-SWITCH	TL3301AF160QG	EG2526CT-ND
SWITCH DIP LOW PRO 5 POS GOLD	S2	1		E-Switch	KAJ05LAGT	EG4429-ND
OP AMP, R-R W/DIS-ABLE, 190MHZ	U1	1	LM6639	NATIONAL SEMI	LMH6639MF/NOPB	LMH6639MFCT-ND
CY8CPLC10 Part	U2	1		Cypress	CY8CPLC10-28PVXI	
VOLT REG, ADJUST-ABLE 1.2-37V, 1.5A, SMD, DPAK	U7	1	+ADJ	ST MICRO	LM317MDT-TR	497-1574-1-ND
CRYSTAL 32.768KHZ 12.5PF, CYLINDER, SERIES ECS-31X	Y1	1	32.768KHZ	ECS INC	ECS-3X8X	X1123-ND
OSC 24.000MHZ 5.0V +/-100PPM SMD	Y2	1	24.00 MHz	Crystek	C3290-24.000	C3290-24.000-ND
	Y2 (2nd source)			Citizen	CSX750FCC24.000 M-UT	300-7214-2-ND