

Three-terminal positive voltage regulator
 OUTPUT CURRENT TO 1.2A
 OUTPUT VOLTAGES OF 5; 6; 8; 9; 12V
 THERMAL OVERLOAD PROTECTION
 SHORT CIRCUIT PROTECTION
 OUTPUT TRANSITION SOA PROTECTION

1、 Absolute Maximum Ratings $T_c=25^{\circ}\text{C}$

| Symbol | Parameter | Value | UNIT |
|--------|-----------------------------|------------|--------------------|
| VI | Input Voltage | 35 | V |
| TOPR | Operating Temperature Range | 0 ~ +125 | $^{\circ}\text{C}$ |
| TSTG | Storage Temperature Range | -65 ~ +150 | $^{\circ}\text{C}$ |

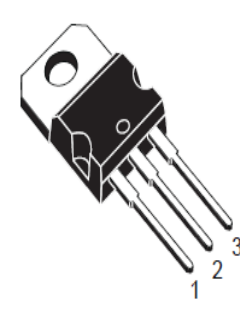

TO-220

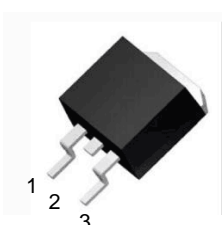

TO-263-3

1 Input 2 Gnd 3 Out

2、 Electrical Characteristics ($T_c=25^{\circ}\text{C}$) Of 7805 (refer to the test circuits, $T_J = -55$ to 150°C $V_I = 10\text{V}$, $I_O = 500\text{ mA}$, $C_I = 0.33\ \mu\text{F}$, $C_O = 0.1\ \mu\text{F}$ unless otherwise specified).

| Parameter | Symbol | Test Condition | MIN | TYP | MAX | UNIT |
|--------------------------|-----------------------|--|----------------------------------|------|------|------------------------|
| Output Voltage | VO | $T_J = +25^{\circ}\text{C}$ | 4.8 | 5 | 5.2 | V |
| | | $I_O = 5\text{mA to } 1\text{A}$, $P_O \leq 15\text{W}$ $V_I = 8\text{V to } 20\text{V}$ | 4.75 | 5 | 5.25 | |
| Line Regulation (Notel) | ΔV_O | $T_J = +25^{\circ}\text{C}$ | $V_I = 7\text{V to } 25\text{V}$ | | 100 | mV |
| | | | $V_I = 8\text{V to } 12\text{V}$ | | 50 | |
| Load Regulation (Notel) | ΔV_O | $T_J = +25^{\circ}\text{C}$ $I_O = 5\text{mA to } 1.2\text{A}$ | | | 100 | mV |
| | | $T_J = +25^{\circ}\text{C}$ $I_O = 250\text{mA to } 750\text{mA}$ | | | 50 | |
| Quiescent Current | IQ | $T_J = +25^{\circ}\text{C}$ | | | 6 | mA |
| Quiescent Current Change | ΔI_Q | $I_O = 5\text{mA to } 1\text{A}$ | | | 0.5 | mA |
| | | $V_I = 8\text{V to } 25\text{V}$ | | | 0.8 | |
| Quiescent Current Change | $\Delta V_O/\Delta T$ | $I_O = 5\text{mA}$ | | 0.6 | | mV/ $^{\circ}\text{C}$ |
| Short Circuit Current | ISC | $T_J = +25^{\circ}\text{C}$, $V_I = 35\text{V}$ | | 0.75 | 1.2 | A |

3、Electrical Characteristics (Tc=25°C) Of 7806(refer to the test circuits,TJ = -55 to 150°C VI = 11V ,
IO = 500 mA , CI = 0.33 μ F , CO = 0.1 μ F unless otherwise specified)。

| Parameter | Symbol | Test Condition | MIN | TYP | MAX | UNIT |
|--------------------------|----------|--|----------------|------|------|-------|
| Output Voltage | VO | TJ = +25°C | 5.75 | 6 | 6.25 | V |
| | | IO = 5mA to 1A, PO ≤ 15W VI = 9V to 21V | 5.7 | 6 | 6.3 | |
| Line Regulation (Note1) | Δ VO | TJ = +25°C | VI = 8V to 25V | | 100 | mV |
| | | | VI = 9V to 13V | | 50 | |
| Load Regulation (Note1) | Δ VO | TJ = +25°C IO = 5mA to 1.2A | | | 100 | mV |
| | | TJ = +25°C IO = 250mA to 750mA | | | 50 | |
| Quiescent Current | IQ | TJ = +25°C | | | 6 | mA |
| Quiescent Current Change | Δ IQ | IO = 5mA to 1A | | | 0.5 | mA |
| | | VI = 9V to 25V | | | 0.8 | |
| Quiescent Current Change | Δ VO/Δ T | IO = 5mA | | 0.7 | | mV/°C |
| Short Circuit Current | ISC | TJ = +25° C, VI = 35V | | 0.75 | 1.2 | A |

4、Electrical Characteristics (Tc=25°C) Of 7808(refer to the test circuits, Tj = -55 to 150°C VI = 14V, IO = 500 mA, CI = 0.33 μ F, CO = 0.1 μ F unless otherwise specified)。

| Parameter | Symbol | Test Condition | MIN | TYP | MAX | UNIT | |
|--------------------------|----------|---|-------------------|------|-----|-------|----|
| Output Voltage | VO | TJ = +25°C | 7.7 | 8 | 8.3 | V | |
| | | IO = 5mA to 1A, PO ≤ 15W VI = 11.5V to 23V | 7.6 | 8 | 8.4 | | |
| Line Regulation (Notel) | Δ VO | TJ = +25°C | VI = 10.5V to 25V | | | 100 | mV |
| | | | VI = 11V to 17V | | | 50 | |
| Load Regulation (Notel) | Δ VO | TJ = +25°C IO = 5mA to 1.2A | | | 100 | mV | |
| | | TJ = +25°C IO = 250mA to 750mA | | | 50 | | |
| Quiescent Current | IQ | TJ = +25°C | | | 6 | mA | |
| Quiescent Current Change | Δ IQ | IO = 5mA to 1A | | | 0.5 | mA | |
| | | VI = 11.5V to 25V | | | 1 | | |
| Quiescent Current Change | Δ Vo/Δ T | IO = 5mA | | 1 | | mV/°C | |
| Short Circuit Current | ISC | TJ = +25° C, VI = 35V | | 0.75 | 1.2 | A | |

5、Electrical Characteristics ($T_c=25^{\circ}\text{C}$) Of 7809(refer to the test circuits, $T_J = -55$ to 150°C $V_I = 15\text{V}$, $I_O = 500\text{ mA}$, $C_I = 0.33\ \mu\text{F}$, $C_O = 0.1\ \mu\text{F}$ unless otherwise specified)。

| Parameter | Symbol | Test Condition | MIN | TYP | MAX | UNIT | |
|--------------------------|-----------------------|---|------------------------------------|------|------|------------------------|----|
| Output Voltage | V_O | $T_J = +25^{\circ}\text{C}$ | 8.64 | 9 | 9.36 | V | |
| | | $I_O = 5\text{mA to }1\text{A}$, $P_O \leq 15\text{W}$ $V_I = 11.5\text{V to }26\text{V}$ | 8.55 | 9 | 9.45 | | |
| Line Regulation (Note1) | ΔV_O | $T_J = +25^{\circ}\text{C}$ | $V_I = 11.5\text{V to }26\text{V}$ | | | 100 | mV |
| | | | $V_I = 12\text{V to }18\text{V}$ | | | 50 | |
| Load Regulation (Note1) | ΔV_O | $T_J = +25^{\circ}\text{C}$ $I_O = 5\text{mA to }1.2\text{A}$ | | | 100 | mV | |
| | | $T_J = +25^{\circ}\text{C}$ $I_O = 250\text{mA to }750\text{mA}$ | | | 50 | | |
| Quiescent Current | I_Q | $T_J = +25^{\circ}\text{C}$ | | | 6 | mA | |
| Quiescent Current Change | ΔI_Q | $I_O = 5\text{mA to }1\text{A}$ | | | 0.5 | mA | |
| | | $V_I = 11.5\text{V to }26\text{V}$ | | | 1 | | |
| Quiescent Current Change | $\Delta V_O/\Delta T$ | $I_O = 5\text{mA}$ | | 1 | | mV/ $^{\circ}\text{C}$ | |
| Short Circuit Current | ISC | $T_J = +25^{\circ}\text{C}$, $V_I = 35\text{V}$ | | 0.75 | 1.2 | A | |

6、Electrical Characteristics ($T_c=25^{\circ}\text{C}$) Of 7812 (refer to the test circuits, $T_J = -55$ to 150°C $V_I = 19\text{V}$, $I_O = 500\text{ mA}$, $C_I = 0.33\ \mu\text{F}$, $C_O = 0.1\ \mu\text{F}$ unless otherwise specified)。

| Parameter | Symbol | Test Condition | MIN | TYP | MAX | UNIT |
|--------------------------|-----------------------|---|-------------------------------------|------|------|------------------------|
| Output Voltage | V_O | $T_J = +25^{\circ}\text{C}$ | 11.5 | 12 | 12.5 | V |
| | | $I_O = 5\text{mA to } 1\text{A}$, $P_O \leq 15\text{W}$ $V_I = 15.5\text{V to } 27\text{V}$ | 11.4 | 12 | 12.6 | |
| Line Regulation (Note1) | ΔV_O | $T_J = +25^{\circ}\text{C}$ | $V_I = 14.5\text{V to } 30\text{V}$ | | 100 | mV |
| | | | $V_I = 16\text{V to } 22\text{V}$ | | 50 | |
| Load Regulation (Note1) | ΔV_O | $T_J = +25^{\circ}\text{C}$ $I_O = 5\text{mA to } 1.2\text{A}$ | | | 100 | mV |
| | | $T_J = +25^{\circ}\text{C}$ $I_O = 250\text{mA to } 750\text{mA}$ | | | 50 | |
| Quiescent Current | I_Q | $T_J = +25^{\circ}\text{C}$ | | | 6 | mA |
| Quiescent Current Change | ΔI_Q | $I_O = 5\text{mA to } 1\text{A}$ | | | 0.5 | mA |
| | | $V_I = 15\text{V to } 30\text{V}$ | | | 1 | |
| Quiescent Current Change | $\Delta V_O/\Delta T$ | $I_O = 5\text{mA}$ | | 1.5 | | mV/ $^{\circ}\text{C}$ |
| Short Circuit Current | ISC | $T_J = +25^{\circ}\text{C}$, $V_I = 35\text{V}$ | | 0.75 | 1.2 | A |

7、Typical Characteristics

Figure 1: Dropout Voltage vs Junction Temperature

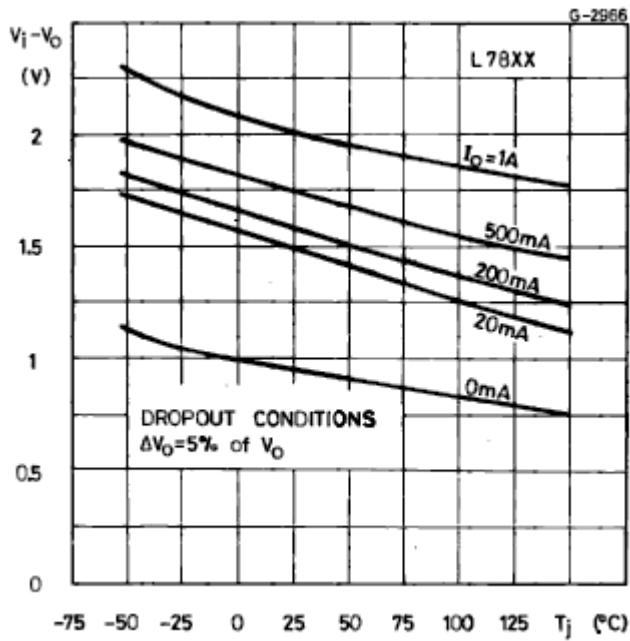

Figure 2: Peak Output Current vs Input/output Differential Voltage

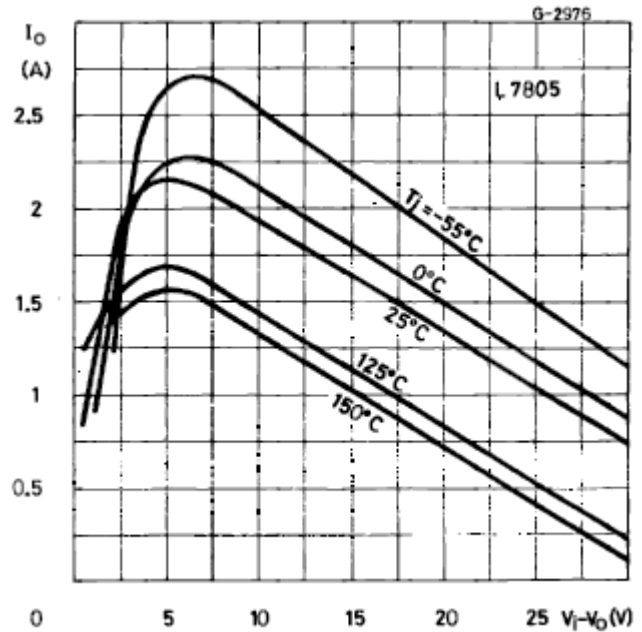

Figure 3: Supply Voltage Rejection vs Frequency

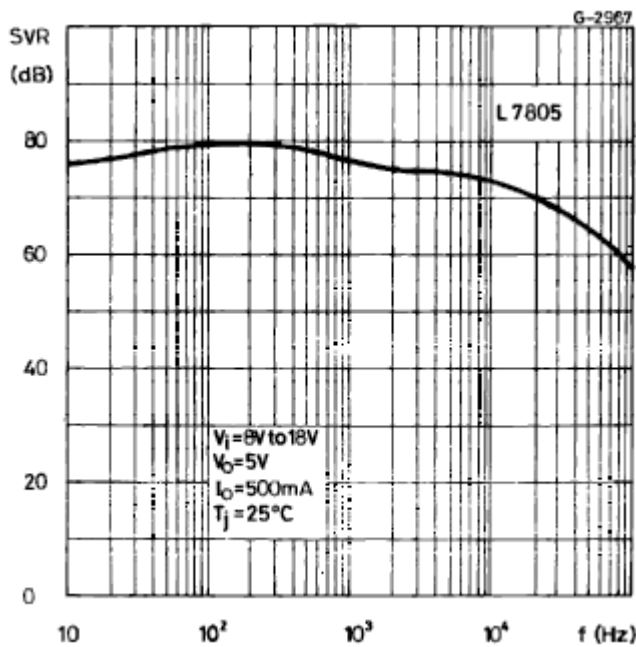

Figure 4: Quiescent Current vs Junction Temperature

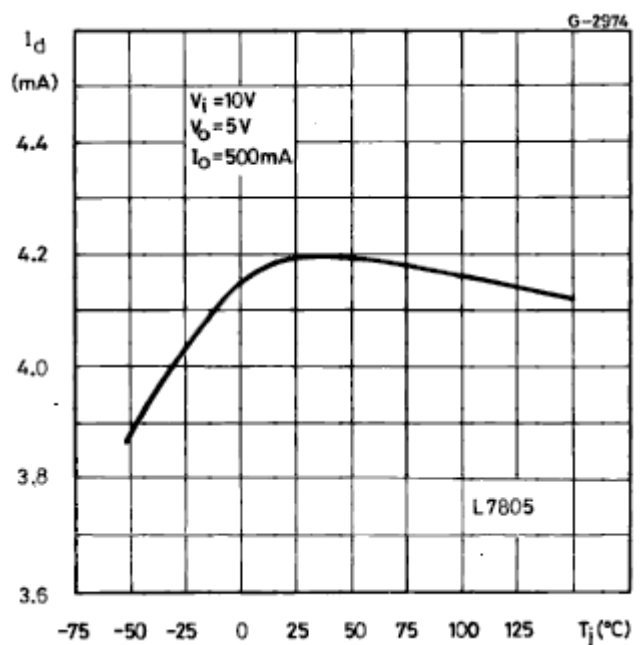

Figure 5: Output Voltage vs Junction Temperature

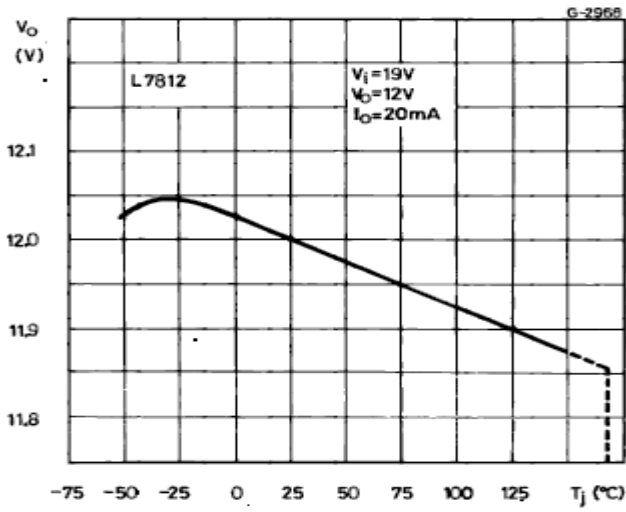

Figure 6: Load Transient Response

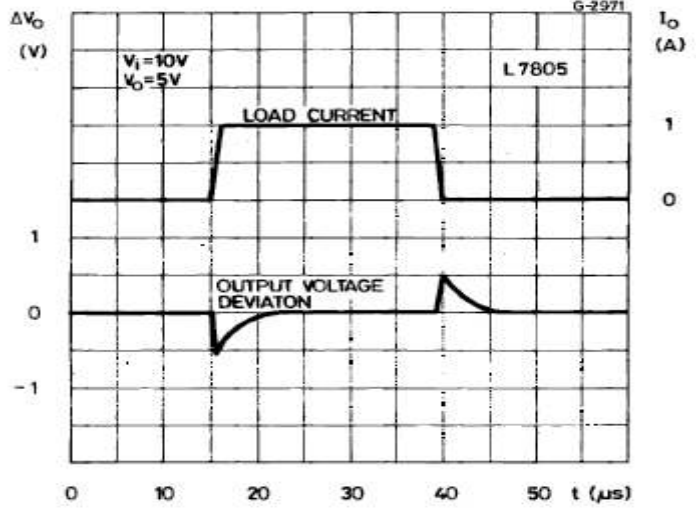

Figure 7: Output Impedance vs Frequency

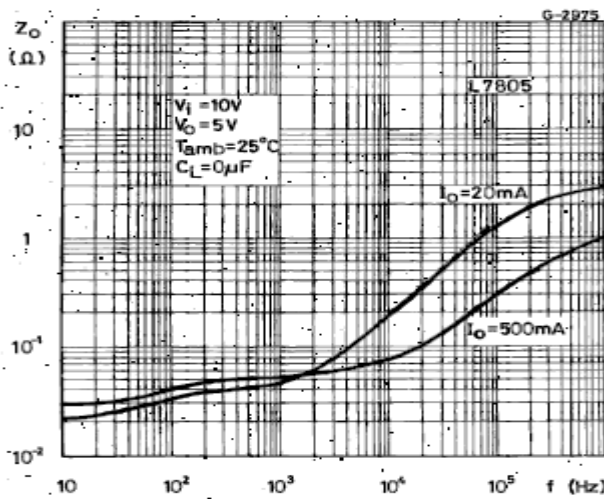

Figure 8: Line Transient Response

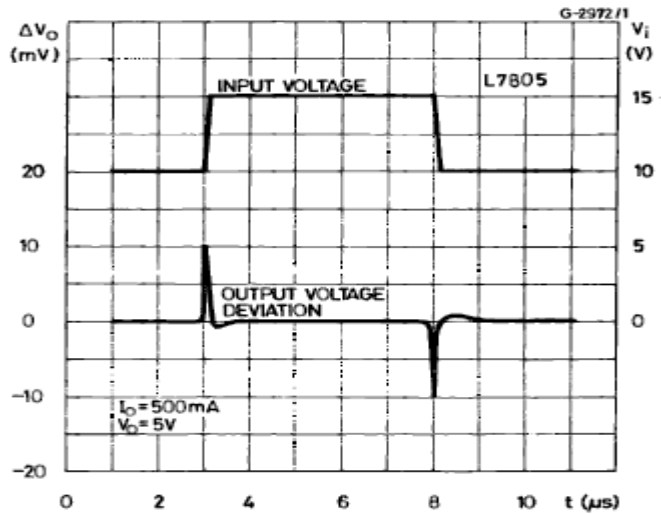
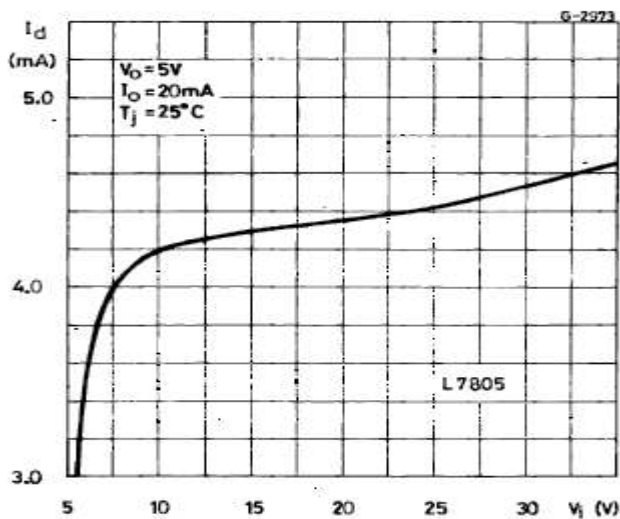

Figure 9: Quiescent Current vs Input Voltage



8、Package Demensions

T0-263-3

T0-263封装尺寸:

UNIT: mm

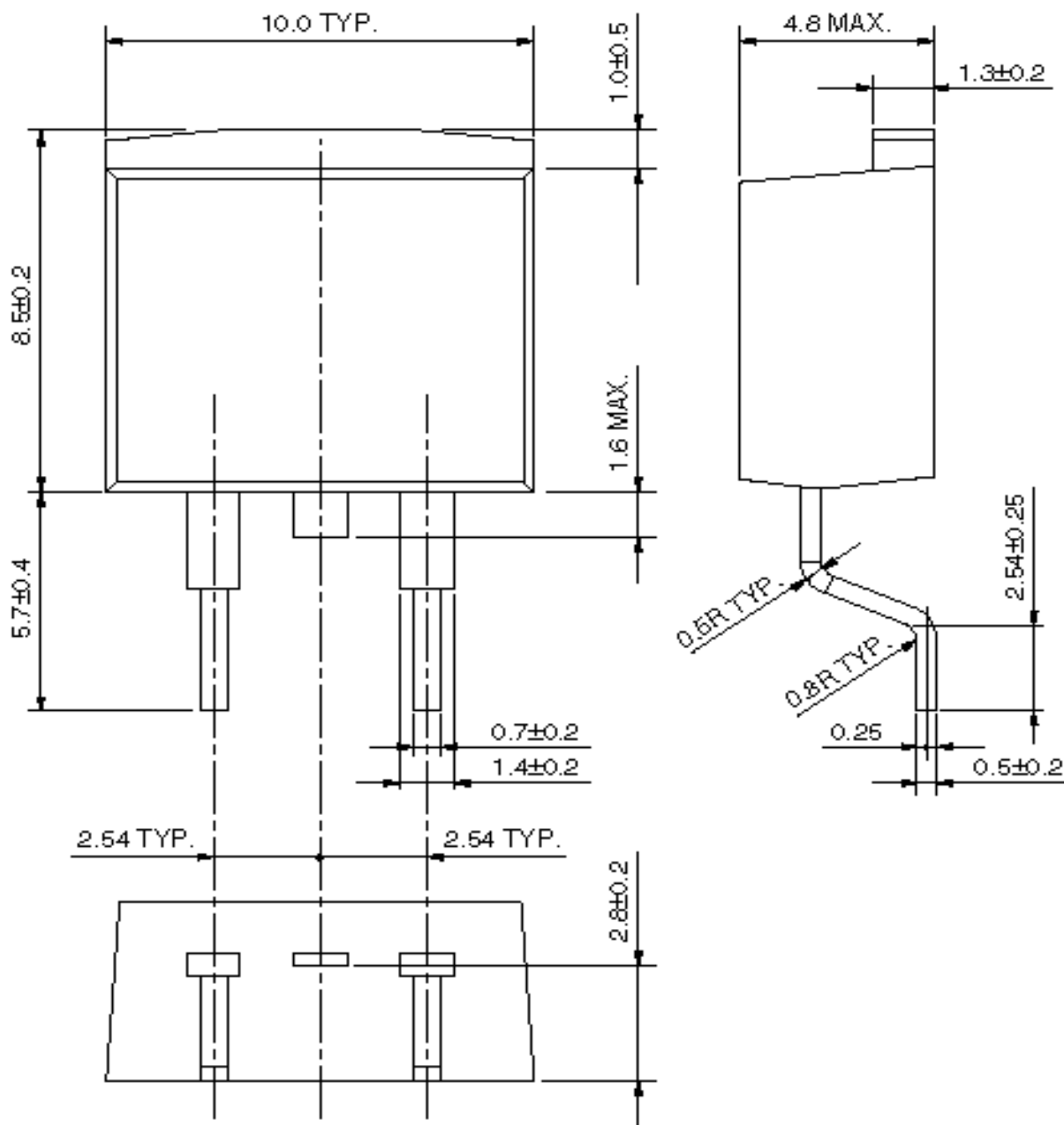

: The area without solder plated

9、Package Demensions

T0-220

| DIM. | mm. | | | inch | | |
|------|-------|------|-------|-------|-------|-------|
| | MIN. | TYP. | MAX. | MIN. | TYP. | MAX. |
| A | 4.40 | | 4.60 | 0.173 | | 0.181 |
| b | 0.61 | | 0.88 | 0.024 | | 0.034 |
| b1 | 1.15 | | 1.70 | 0.045 | | 0.067 |
| c | 0.49 | | 0.70 | 0.019 | | 0.027 |
| D | 15.25 | | 15.75 | 0.600 | | 0.620 |
| E | 10.0 | | 10.40 | 0.393 | | 0.409 |
| e | 2.4 | | 2.7 | 0.094 | | 0.106 |
| e1 | 4.95 | | 5.15 | 0.194 | | 0.203 |
| F | 1.23 | | 1.32 | 0.048 | | 0.051 |
| H1 | 6.2 | | 6.6 | 0.244 | | 0.260 |
| J1 | 2.40 | | 2.72 | 0.094 | | 0.107 |
| L | 13.0 | | 14.0 | 0.511 | | 0.551 |
| L1 | 3.5 | | 3.93 | 0.137 | | 0.154 |
| L20 | | 16.4 | | | 0.645 | |
| L30 | | 28.9 | | | 1.138 | |
| φP | 3.75 | | 3.85 | 0.147 | | 0.151 |
| Q | 2.65 | | 2.95 | 0.104 | | 0.116 |

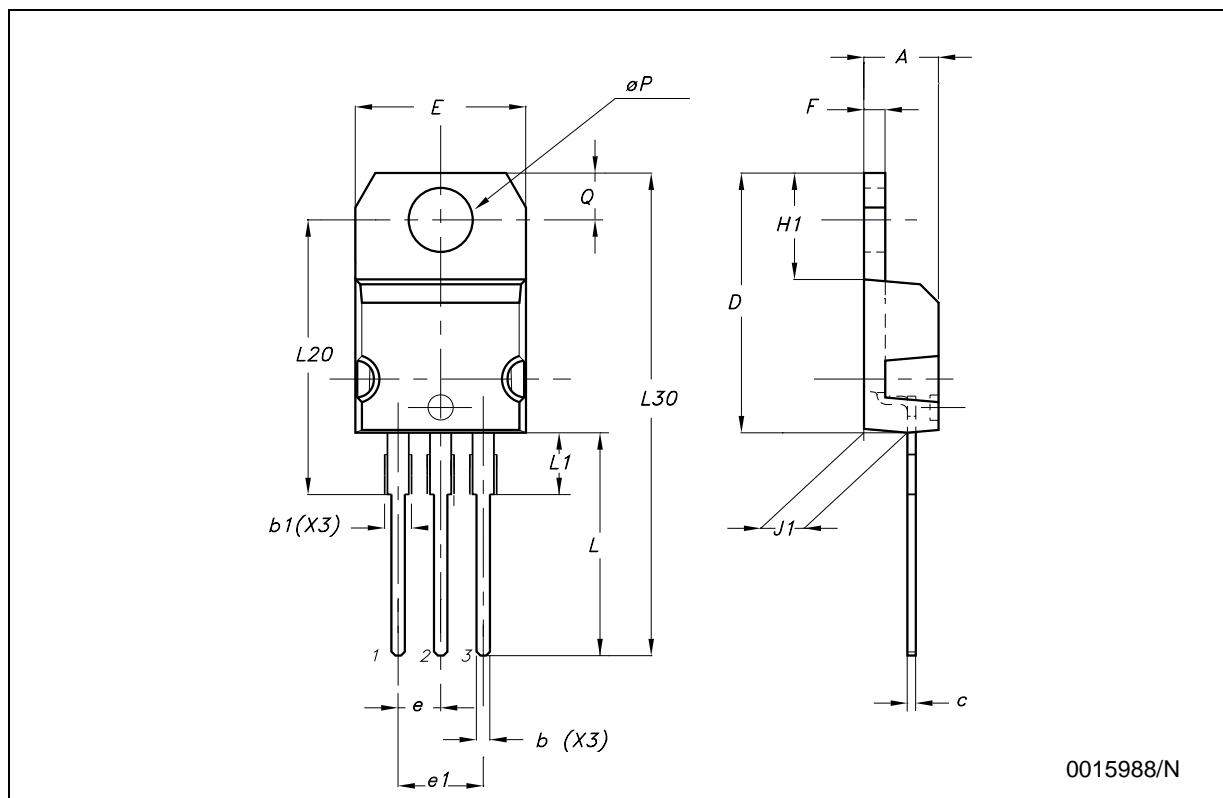

0015988/N