

# TA2105

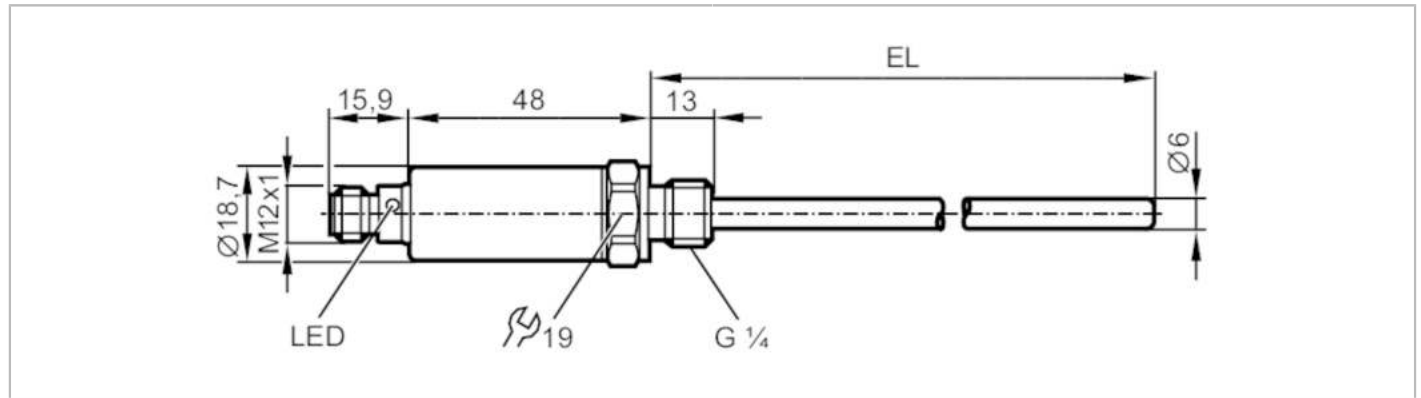

## Temperature transmitter

TA-025CLER14-A-ZVG/US



Product characteristics	
Number of inputs and outputs	Number of analogue outputs: 1
Measuring range [°C]	-50...150
Process connection	threaded connection G 1/4
Installation length EL [mm]	25
Application	
Special feature	Gold-plated contacts
Measuring element	1 x Pt 1000; (to DIN EN 60751, class A)
Media	liquids and gases
Pressure rating [bar]	400
Note on pressure rating	sensor
When mounted in adapters the specifications of the adapter data sheet apply.	
Electrical data	
Operating voltage [V]	18...32 DC; ("supply class 2" to cULus)
Current consumption [mA]	< 50
Protection class	III
Reverse polarity protection	yes
Power-on delay time [s]	1
Inputs / outputs	
Number of inputs and outputs	Number of analogue outputs: 1
Outputs	
Total number of outputs	1
Output signal	analogue signal; IO-Link; (configurable)
Number of analogue outputs	1
Analogue current output [mA]	4...20
Max. load [Ω]	250; ((18...19 V); 19...32 V: 300 Ω)
Short-circuit protection	yes
Overload protection	yes
Measuring/setting range	
Measuring range [°C]	-50...150
Factory setting	-50...150 °C

# TA2105



## Temperature transmitter

TA-025CLER14-A-ZVG/US

<b>Resolution</b>		
Resolution of analogue output	[K]	0.04
<b>Accuracy / deviations</b>		
Precision analogue output	[K]	$\pm 0,3 + (\pm 0,1 \% \text{ MS})$
Temperature coefficient [% of the span / 10 K]		0,1; (in case of deviation from the reference condition $25 \pm 5 \text{ }^\circ\text{C}$ )
<b>Response times</b>		
Dynamic response T05 / T09	[s]	1 / 3
<b>Interfaces</b>		
Communication interface		IO-Link
Transmission type		COM2 (38,4 kBaud)
IO-Link revision		1.1
<b>Operating conditions</b>		
Ambient temperature	[ $^\circ\text{C}$ ]	-25...80
Storage temperature	[ $^\circ\text{C}$ ]	-40...100
Protection		IP 67; IP 68; IP 69K
<b>Tests / approvals</b>		
EMC		DIN EN 61000-6-2
Shock resistance		DIN IEC 68-2-27 50 g (11 ms)
Vibration resistance		DIN IEC 68-2-6 20 g (10...2000 Hz)
MTTF	[years]	572
UL approval		UL Approval no. K002
<b>Mechanical data</b>		
Weight	[g]	84
Dimensions	[mm]	$\varnothing 18.7$
Materials		stainless steel (1.4404 / 316L); PEI; FKM
Materials (wetted parts)		stainless steel (1.4404 / 316L); O-ring: FKM
Tightening torque	[Nm]	35
Process connection		threaded connection G 1/4
Probe diameter	[mm]	6
Installation length EL	[mm]	25
<b>Displays / operating elements</b>		
Display	operating status	1 x LED, green
<b>Remarks</b>		
Remarks		MS = set measuring span
Pack quantity		1 pcs.

# TA2105



## Temperature transmitter

TA-025CLER14-A-ZVG/US

### Electrical connection

Connector: 1 x M12; coding: A; Contacts: gold-plated



### Connection

