

1-1355350-1 ✓ ACTIVE

AMP | MQS

TE Internal #: 1-1355350-1

Automotive Connector Caps & Covers, Shield Assembly, Cable Exit Angle 180°, Black, PBT GF, 18 Position, -40 – 248 °F [-40 – 120 °C], MQS

[View on TE.com >](#)



Connectors > Automotive Connectors > Automotive Connector Accessories > Automotive Connector Caps & Covers

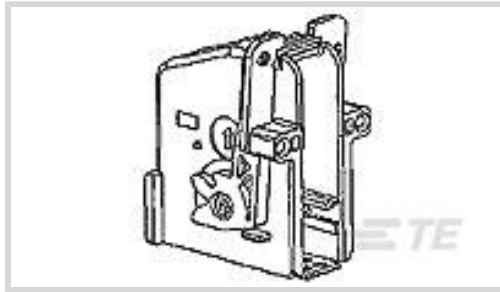

Protection & Strain Relief Accessory Type: **Shield Assembly**

Cable Exit Angle: **180°**

Strain Relief: **Without**

Primary Product Color: **Black**

Primary Product Material: **PBT GF**

## Features

### Product Type Features

Protection & Strain Relief Accessory Type	Shield Assembly
---	-----------------

### Configuration Features

Number of Positions	18
---------------------	----

### Body Features

Cable Exit Angle	180°
Primary Product Color	Black
Primary Product Material	PBT GF

### Mechanical Attachment

Strain Relief	Without
---------------	---------

### Dimensions

Compatible Cable Bundle Diameter Range	4.3 mm[.169 in]
--	-----------------

### Usage Conditions

Operating Temperature (Max)	70 °C, 75 °C, 80 °C, 85 °C, 90 °C, 100 °C, 105 °C, 110 °C, 120 °C[158 °F][167 °F][176 °F][185 °F][194 °F][212 °F][221 °F][230 °F][248 °F]
Operating Temperature Range	-40 – 120 °C[-40 – 248 °F]

### Industry Standards

--	--



UL Flammability Rating	UL 94HB
------------------------	---------

### Packaging Features

Packaging Method	Carton
------------------	--------

### Other

Serviceable	Yes
-------------	-----

## Product Compliance

[For compliance documentation, visit the product page on TE.com>](#)

EU RoHS Directive 2011/65/EU	Compliant
------------------------------	-----------

EU ELV Directive 2000/53/EC	Compliant
-----------------------------	-----------

China RoHS 2 Directive MIIT Order No 32, 2016	No Restricted Materials Above Threshold
---	---

EU REACH Regulation (EC) No. 1907/2006	Current ECHA Candidate List: JUNE 2023 (235) Candidate List Declared Against: JAN 2023 (233) Does not contain REACH SVHC
--	--

Halogen Content	Low Halogen - Br, Cl, F, I < 900 ppm per homogenous material. Also BFR/CFR/PVC Free
-----------------	---

Solder Process Capability	Not applicable for solder process capability
---------------------------	--

#### Product Compliance Disclaimer

This information is provided based on reasonable inquiry of our suppliers and represents our current actual knowledge based on the information they provided. This information is subject to change. The part numbers that TE has identified as EU RoHS compliant have a maximum concentration of 0.1% by weight in homogenous materials for lead, hexavalent chromium, mercury, PBB, PBDE, DBP, BBP, DEHP, DIBP, and 0.01% for cadmium, or qualify for an exemption to these limits as defined in the Annexes of Directive 2011/65/EU (RoHS2). Finished electrical and electronic equipment products will be CE marked as required by Directive 2011/65/EU. Components may not be CE marked. Additionally, the part numbers that TE has identified as EU ELV compliant have a maximum concentration of 0.1% by weight in homogenous materials for lead, hexavalent chromium, and mercury, and 0.01% for cadmium, or qualify for an exemption to these limits as defined in the Annexes of Directive 2000/53/EC (ELV). Regarding the REACH Regulation, the information TE provides on SVHC in articles for this part number is based on the latest European Chemicals Agency (ECHA) 'Guidance on requirements for substances in articles' posted at this URL: <https://echa.europa.eu/guidance-documents/guidance-on-reach>

## Compatible Parts

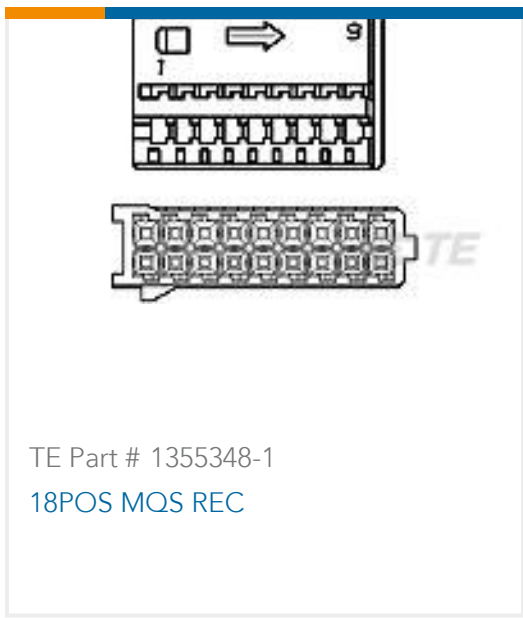

Also in the Series | **MQS**

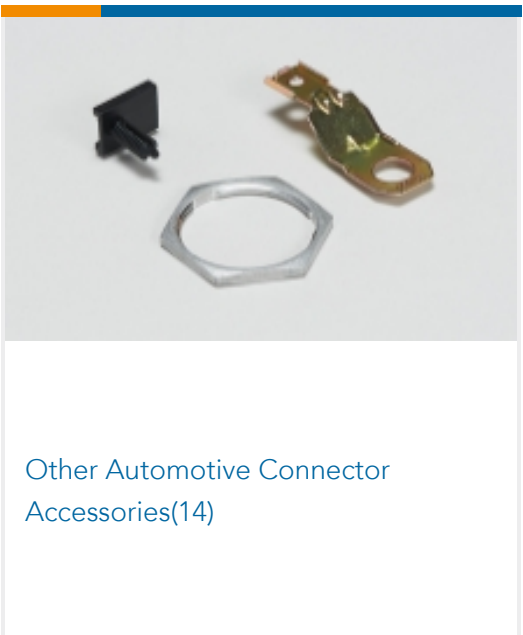
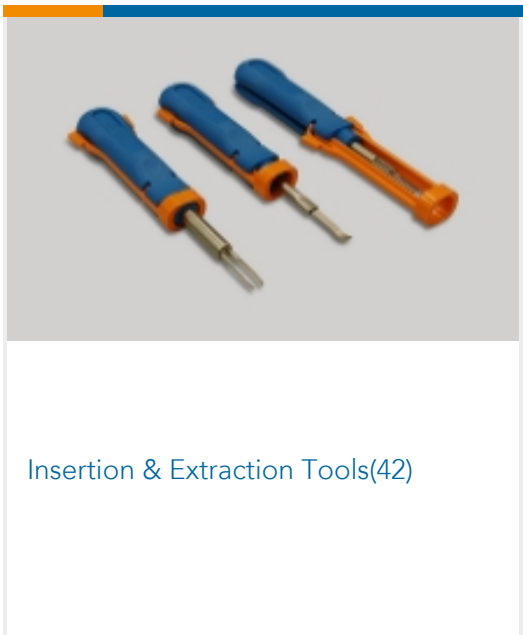
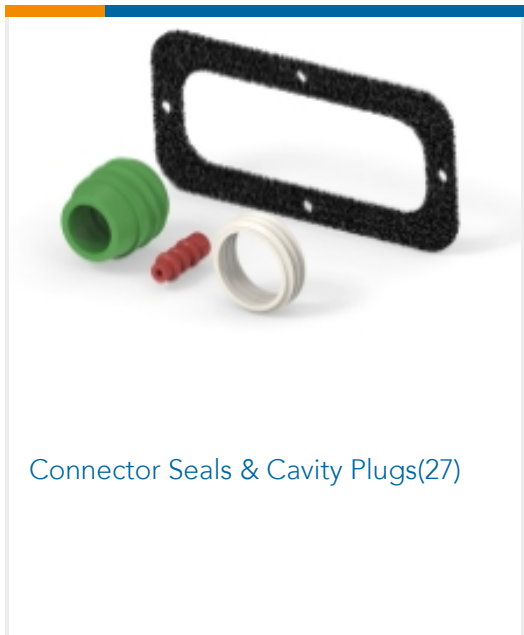
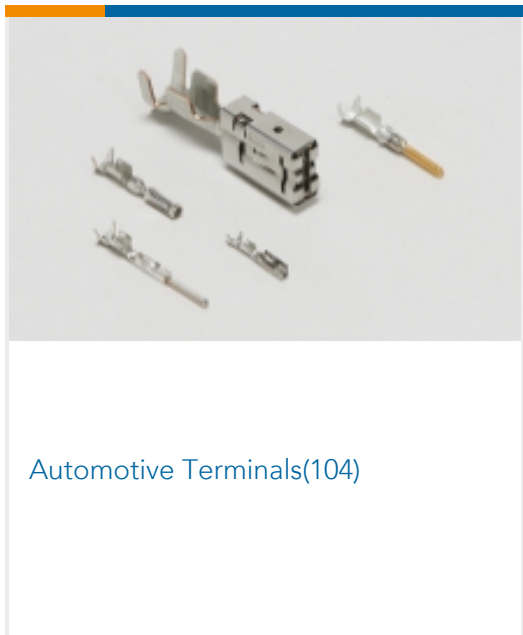
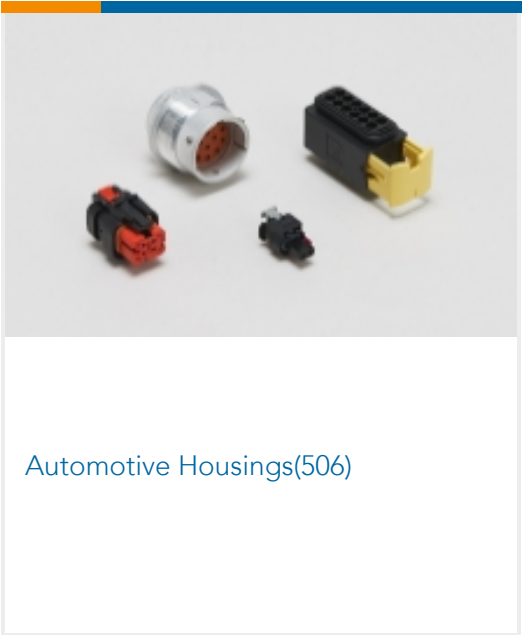
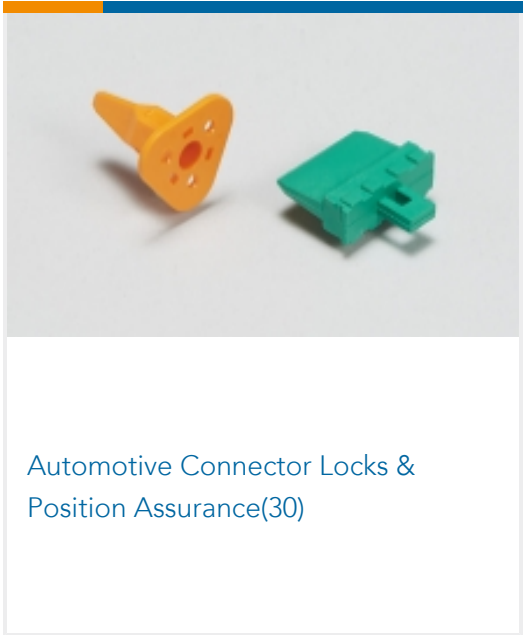
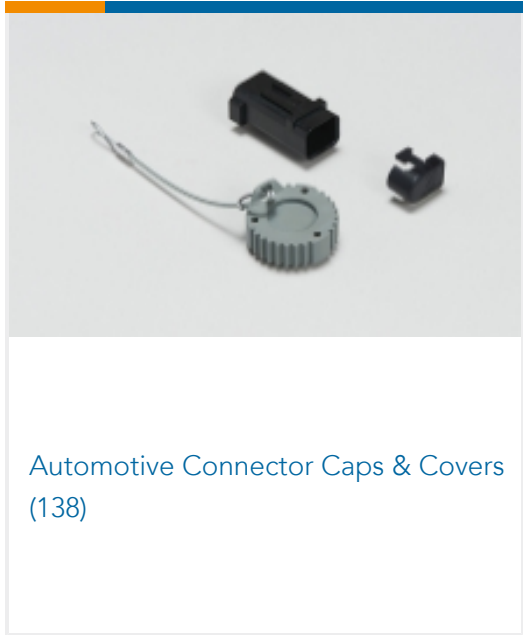

Customers Also Bought

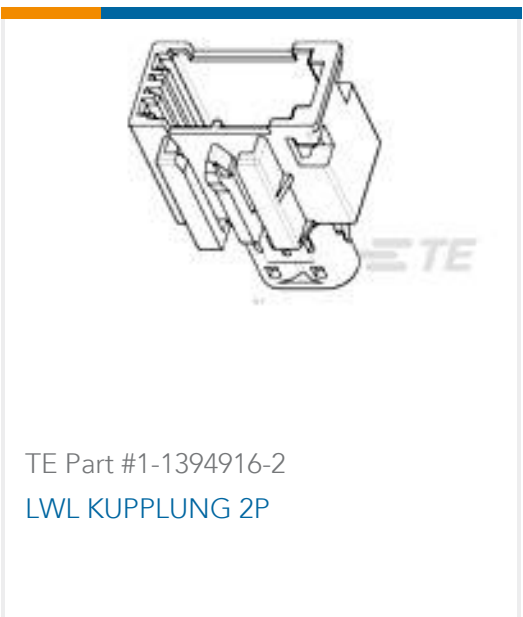

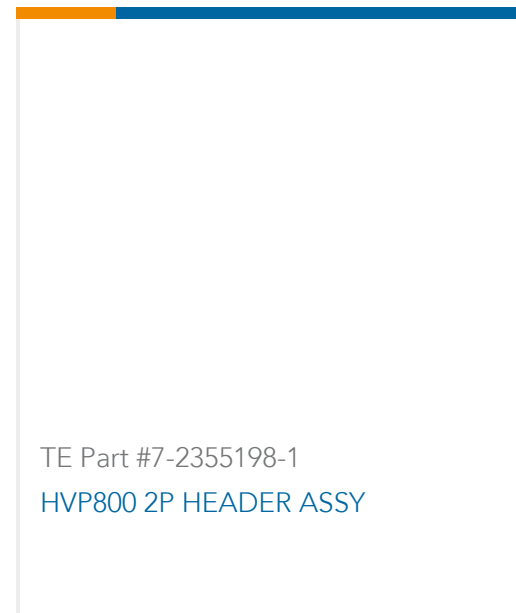

## Documents

### Product Drawings

#### MQS ABDECKKAPPE 18P

English

### CAD Files

#### 3D PDF

English

#### Customer View Model

[ENG\\_CVM\\_1-1355350-1\\_A1.2d\\_dxf.zip](#)

English

#### Customer View Model

[ENG\\_CVM\\_1-1355350-1\\_A1.3d\\_igs.zip](#)

English

#### Customer View Model

[ENG\\_CVM\\_1-1355350-1\\_A1.3d\\_stp.zip](#)

English

By downloading the CAD file I accept and agree to the [Terms and Conditions](#) of use.

### Product Specifications

#### Micro Quardlok System Female Connectors

English

#### Product Specification

English