

TRF370417 50-MHz to 6-GHz Quadrature Modulator

1 Features

- 76-dBc Single-Carrier WCDMA ACPR at –8 dBm Channel Power
- Low Noise Floor: –162.3 dBm/Hz at 2140 MHz
- OIP3 of 26.5 dBm at 2140 MHz
- P1dB of 12 dBm at 2140 MHz
- Carrier Feedthrough of –38 dBm at 2140 MHz
- Side-Band Suppression of –50 dBc at 2140 MHz
- Single Supply: 4.5-V–5.5-V Operation
- Silicon Germanium Technology
- 1.7-V CM at I, Q Baseband Inputs

2 Applications

- Cellular Base Station Transceiver
- CDMA: IS95, UMTS, CDMA2000, TD-SCDMA
- TDMA: GSM, IS-136, EDGE/UWC-136
- Multicarrier GSM
- WiMAX: 802.16d/e
- 3GPP: LTE
- Point-to-Point (P2P) Microwave
- Wideband Software-Defined Radio
- Public Safety: TETRA/APC025
- Communication-System Testers
- Cable Modem Termination System (CMTS)

3 Description

The TRF370417 is a low-noise direct quadrature modulator, capable of converting complex modulated signals from baseband or IF directly up to RF. The TRF370417 is a high-performance, superior-linearity device that operates at RF frequencies of 50 MHz through 6 GHz. The modulator is implemented as a differential to single-ended converter. The RF output block consists of a differential to single-ended converter and an RF amplifier capable of driving a single-ended 50-Ω load without any need of external components. The TRF370417 requires a 1.7-V common-mode voltage for optimum linearity performance.

Device Information⁽¹⁾

PART NUMBER	PACKAGE	BODY SIZE (NOM)
TRF370417	VQFN(24)	4.00 mm × 4.00 mm

(1) For all available packages, see the orderable addendum at the end of the data sheet.

Block Diagram

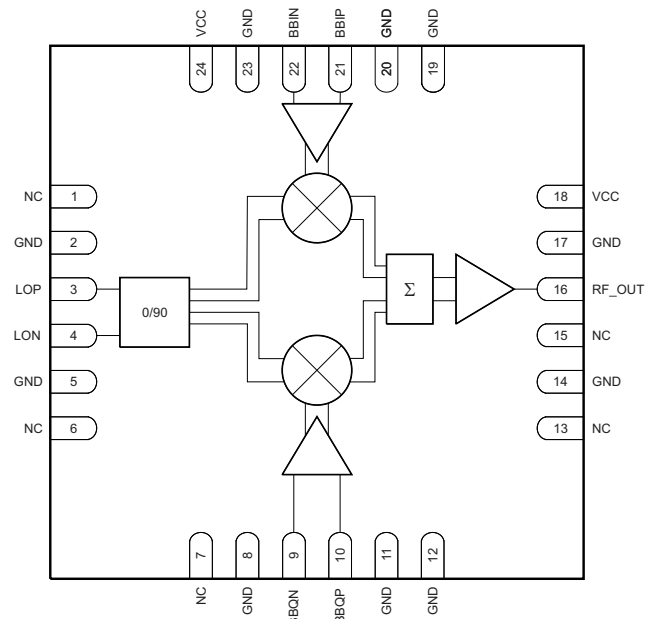

B0175-01



Table of Contents

1 Features 1 2 Applications 1 3 Description 1 4 Revision History 2 5 Pin Configuration and Functions 3 6 Specifications 4 6.1 Absolute Maximum Ratings 4 6.2 ESD Ratings 4 6.3 Recommended Operating Conditions 4 6.4 Thermal Information 4 6.5 Electrical Characteristics 5 6.6 RF Output Parameters 5 6.7 Typical Characteristics 8 7 Detailed Description 16 7.1 Overview 16 7.2 Functional Block Diagram 16 7.3 Feature Description 16	7.4 Device Functional Modes 16 8 Application and Implementation 18 8.1 Application Information 18 8.2 Typical Application 20 9 Power Supply Recommendations 23 10 Layout 23 10.1 Layout Guidelines 23 10.2 Layout Example 23 11 Device and Documentation Support 25 11.1 Device Support 25 11.2 Documentation Support 26 11.3 Community Resources 26 11.4 Trademarks 26 11.5 Electrostatic Discharge Caution 26 11.6 Glossary 26 12 Mechanical, Packaging, and Orderable Information 26
---	---

4 Revision History

NOTE: Page numbers for previous revisions may differ from page numbers in the current version.

Changes from Original (January 2010) to Revision A	Page
<ul style="list-style-type: none"> • Added <i>ESD Ratings</i> table, <i>Feature Description</i> section, <i>Device Functional Modes</i>, <i>Application and Implementation</i> section, <i>Power Supply Recommendations</i> section, <i>Layout</i> section, <i>Device and Documentation Support</i> section, and <i>Mechanical, Packaging, and Orderable Information</i> section. 	1

5 Pin Configuration and Functions

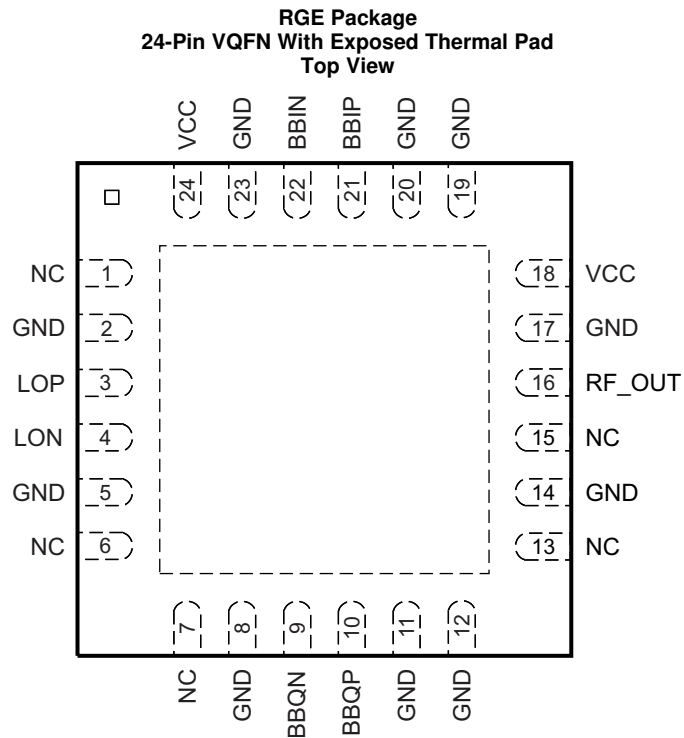

Pin Functions

PIN		I/O	DESCRIPTION
NAME	NO.		
BBIN	22	I	In-phase negative input
BBIP	21	I	In-phase positive input
BBQN	9	I	Quadrature-phase negative input
BBQP	10	I	Quadrature-phase positive input
GND	2, 5, 8, 11, 12, 14, 17, 19, 20, 23	—	Ground
LON	4	I	Local oscillator (LO) negative input
LOP	3	I	Local oscillator (LO) positive input
NC	1, 6, 7, 13, 15	—	No connect
RF_OUT	16	O	RF output
VCC	18, 24	—	Power supply

6 Specifications

6.1 Absolute Maximum Ratings

over operating free-air temperature range (unless otherwise noted)⁽¹⁾

	MIN	MAX	UNIT
Supply voltage range	−0.3	6	V
T _J Operating virtual junction temperature range	−40	150	°C
T _A Operating ambient temperature range	−40	85	°C
T _{stg} Storage temperature range	−65	150	°C

- (1) Stresses beyond those listed under *Absolute Maximum Ratings* may cause permanent damage to the device. These are stress ratings only, which do not imply functional operation of the device at these or any other conditions beyond those indicated under *Recommended Operating Conditions*. Exposure to absolute-maximum-rated conditions for extended periods may affect device reliability.

6.2 ESD Ratings

	VALUE	UNIT
V _(ESD) Electrostatic discharge	Human-body model (HBM), per ANSI/ESDA/JEDEC JS-001 ⁽¹⁾	±75
	Charged-device model (CDM), per JEDEC specification JESD22-C101 ⁽²⁾	±75

- (1) JEDEC document JEP155 states that 500-V HBM allows safe manufacturing with a standard ESD control process.
 (2) JEDEC document JEP157 states that 250-V CDM allows safe manufacturing with a standard ESD control process.

6.3 Recommended Operating Conditions

over operating free-air temperature range (unless otherwise noted)

	MIN	NOM	MAX	UNIT
V _{CC} Power-supply voltage	4.5	5	5.5	V

6.4 Thermal Information

THERMAL METRIC ⁽¹⁾	TRF370417	UNIT
	RGE (VQFN)	
	24 PINS	
R _{θJA} Junction-to-ambient thermal resistance (High-K board, still air)	29.4	°C/W
R _{θJC(top)} Junction-to-case (top) thermal resistance	18.6	°C/W
R _{θJB} Junction-to-board thermal resistance	14	°C/W
Ψ _{JT} Junction-to-top characterization parameter	—	°C/W
Ψ _{JB} Junction-to-board characterization parameter	—	°C/W
R _{θJC(bot)} Junction-to-case (bottom) thermal resistance	—	°C/W

- (1) For more information about traditional and new thermal metrics, see the *Semiconductor and IC Package Thermal Metrics* application report, [SPRA953](#).

6.5 Electrical Characteristics

over operating free-air temperature range (unless otherwise noted)

PARAMETER		TEST CONDITIONS	MIN	TYP	MAX	UNIT
DC Parameters						
I_{CC}	Total supply current (1.7 V CM)	$T_A = 25^\circ\text{C}$		205	245	mA
LO Input (50-Ω, Single-Ended)						
f_{LO}	LO frequency range		0.05		6	GHz
	LO input power		-5	0	12	dBm
	LO port return loss			15		dB
Baseband Inputs						
V_{CM}	I and Q input dc common voltage			1.7		
BW	1-dB input frequency bandwidth			1		GHz
$Z_{l(\text{single ended})}$	Input impedance, resistance			5		k Ω
	Input impedance, parallel capacitance			3		pF

6.6 RF Output Parameters

 over recommended operating conditions, power supply = 5 V, $T_A = 25^\circ\text{C}$, $V_{CM} = 1.7$ V, $V_{inBB} = 98$ mVrms single-ended in quadrature, $f_{BB} = 50$ kHz (unless otherwise noted)

PARAMETER		TEST CONDITIONS	MIN	TYP	MAX	UNIT
$f_{LO} = 70$ MHz at 8 dBm						
G	Voltage gain	Output rms voltage over input I (or Q) rms voltage		-8		dB
P1dB	Output compression point			7.3		dBm
IP3	Output IP3	$f_{BB} = 4.5, 5.5$ MHz; $P_{out} = -8$ dBm per tone		22		dBm
IP2	Output IP2	$f_{BB} = 4.5, 5.5$ MHz; $P_{out} = -8$ dBm per tone		69		dBm
	Carrier feedthrough	Unadjusted		-46		dBm
	Sideband suppression	Unadjusted; $f_{BB} = 4.5, 5.5$ MHz		-27.5		dBc
$f_{LO} = 400$ MHz at 8 dBm						
G	Voltage gain	Output rms voltage over input I (or Q) rms voltage		-1.9		dB
P1dB	Output compression point			11		dBm
IP3	Output IP3	$f_{BB} = 4.5, 5.5$ MHz; $P_{out} = -8$ dBm per tone		24.5		dBm
IP2	Output IP2	$f_{BB} = 4.5, 5.5$ MHz; $P_{out} = -8$ dBm per tone		68		dBm
	Carrier feedthrough	Unadjusted		-38		dBm
	Sideband suppression	Unadjusted; $f_{BB} = 4.5, 5.5$ MHz		-40		dBc
$f_{LO} = 945.6$ MHz at 8 dBm						
G	Voltage gain	Output rms voltage over input I (or Q) rms voltage		-2.5		dB
P1dB	Output compression point			11		dBm
IP3	Output IP3	$f_{BB} = 4.5, 5.5$ MHz; $P_{out} = -8$ dBm per tone		25		dBm
IP2	Output IP2	$f_{BB} = 4.5, 5.5$ MHz; $P_{out} = -8$ dBm per tone		65		dBm
	Carrier feedthrough	Unadjusted		-40		dBm
	Sideband suppression	Unadjusted; $f_{BB} = 4.5, 5.5$ MHz		-42		dBc
	Output return loss			9		dB
	Output noise floor	≥ 13 MHz offset from f_{LO} ; $P_{out} = -5$ dBm		-161.2		dBm/Hz
$f_{LO} = 1800$ MHz at 8 dBm						
G	Voltage gain	Output rms voltage over input I (or Q) rms voltage		-2.5		dB
P1dB	Output compression point			12		dBm
IP3	Output IP3	$f_{BB} = 4.5, 5.5$ MHz; $P_{out} = -8$ dBm per tone		26		dBm
IP2	Output IP2	$f_{BB} = 4.5, 5.5$ MHz; $P_{out} = -8$ dBm per tone		60		dBm
	Carrier feedthrough	Unadjusted		-40		dBm
	Sideband suppression	Unadjusted; $f_{BB} = 4.5, 5.5$ MHz		-50		dBc

RF Output Parameters (continued)

over recommended operating conditions, power supply = 5 V, $T_A = 25^\circ\text{C}$, $V_{CM} = 1.7\text{ V}$, $V_{inBB} = 98\text{ mVrms}$ single-ended in quadrature, $f_{BB} = 50\text{ kHz}$ (unless otherwise noted)

PARAMETER		TEST CONDITIONS	MIN	TYP	MAX	UNIT
Output return loss				8		dB
Output noise floor		$\geq 13\text{ MHz}$ offset from f_{LO} ; $P_{out} = -5\text{ dBm}$		-161.5		dBm/Hz
$f_{LO} = 1960\text{ MHz}$ at 8 dBm						
G	Voltage gain	Output rms voltage over input I (or Q) rms voltage		-2.5		dB
P1dB	Output compression point			12		dBm
IP3	Output IP3	$f_{BB} = 4.5, 5.5\text{ MHz}$; $P_{out} = -8\text{ dBm}$ per tone		26.5		dBm
IP2	Output IP2	$f_{BB} = 4.5, 5.5\text{ MHz}$; $P_{out} = -8\text{ dBm}$ per tone		60		dBm
Carrier feedthrough		Unadjusted		-38		dBm
Sideband suppression		Unadjusted; $f_{BB} = 4.5, 5.5\text{ MHz}$		-50		dBc
Output return loss				8		dB
Output noise floor		$\geq 13\text{ MHz}$ offset from f_{LO} ; $P_{out} = -5\text{ dBm}$		-162		dBm/Hz
EVM	Error vector magnitude (rms)	1 EDGE signal, $P_{out} = -5\text{ dBm}^{(1)}$		0.43%		
ACPR	Adjacent-channel power ratio	1 WCDMA signal; $P_{out} = -8\text{ dBm}^{(2)}$		-76		dBc
		1 WCDMA signal; $P_{out} = -8\text{ dBm}^{(3)}$		-74		
		2 WCDMA signals; $P_{out} = -11\text{ dBm}$ per carrier ⁽³⁾		-68		
		4 WCDMA signals; $P_{out} = -14\text{ dBm}$ per carrier ⁽³⁾		-67		
	Alternate-channel power ratio	1 WCDMA signal; $P_{out} = -8\text{ dBm}^{(2)}$		-80		dBc
		1 WCDMA signal; $P_{out} = -8\text{ dBm}^{(3)}$		-78		
		2 WCDMA signals; $P_{out} = -11\text{ dBm}$ per carrier ⁽³⁾		-72		
		4 WCDMA signals; $P_{out} = -14\text{ dBm}$ per carrier ⁽³⁾		-69		
$f_{LO} = 2140\text{ MHz}$ at 8 dBm						
G	Voltage gain	Output rms voltage over input I (or Q) rms voltage		-2.4		dB
P1dB	Output compression point			12		dBm
IP3	Output IP3	$f_{BB} = 4.5, 5.5\text{ MHz}$; $P_{out} = -8\text{ dBm}$ per tone		26.5		dBm
IP2	Output IP2	$f_{BB} = 4.5, 5.5\text{ MHz}$; $P_{out} = -8\text{ dBm}$ per tone		66		dBm
Carrier feedthrough		Unadjusted		-38		dBm
Sideband suppression		Unadjusted; $f_{BB} = 4.5, 5.5\text{ MHz}$		-50		dBc
Output return loss				8.5		dB
Output noise floor		$\geq 13\text{ MHz}$ offset from f_{LO} ; $P_{out} = -5\text{ dBm}$		-162.3		dBm/Hz
ACPR	Adjacent-channel power ratio	1 WCDMA signal; $P_{out} = -8\text{ dBm}^{(2)}$		-76		dBc
		1 WCDMA signal; $P_{out} = -8\text{ dBm}^{(3)}$		-72		
		2 WCDMA signal; $P_{out} = -11\text{ dBm}$ per carrier ⁽³⁾		-67		
		4 WCDMA signals; $P_{out} = -14\text{ dBm}$ per carrier ⁽³⁾		-66		
	Alternate-channel power ratio	1 WCDMA signal; $P_{out} = -8\text{ dBm}^{(2)}$		-80		dBc
		1 WCDMA signal; $P_{out} = -8\text{ dBm}^{(3)}$		-78		
		2 WCDMA signal; $P_{out} = -11\text{ dBm}^{(3)}$		-74		
		4 WCDMA signals; $P_{out} = -14\text{ dBm}$ per carrier ⁽³⁾		-68		

- (1) The contribution from the source of about 0.28% is not de-embedded from the measurement.
 (2) Measured with DAC5687 as source generator; with 2.5 MHz LPF.
 (3) Measured with DAC5687 as source generator; no external BB filters are used.

RF Output Parameters (continued)

over recommended operating conditions, power supply = 5 V, $T_A = 25^\circ\text{C}$, $V_{CM} = 1.7\text{ V}$, $V_{inBB} = 98\text{ mVrms}$ single-ended in quadrature, $f_{BB} = 50\text{ kHz}$ (unless otherwise noted)

PARAMETER		TEST CONDITIONS	MIN	TYP	MAX	UNIT
$f_{LO} = 2500\text{ MHz at } 8\text{ dBm}$						
G	Voltage gain	Output rms voltage over input I (or Q) rms voltage		-1.6		dB
P1dB	Output compression point			13		dBm
IP3	Output IP3	$f_{BB} = 4.5, 5.5\text{ MHz}$; $P_{out} = -8\text{ dBm}$ per tone		29		dBm
IP2	Output IP2	$f_{BB} = 4.5, 5.5\text{ MHz}$; $P_{out} = -8\text{ dBm}$ per tone		65		dBm
	Carrier feedthrough	Unadjusted		-37		dBm
	Sideband suppression	Unadjusted; $f_{BB} = 4.5, 5.5\text{ MHz}$		-47		dBc
EVM	Error vector magnitude (rms)	WiMAX 5-MHz carrier, $P_{out} = -8\text{ dBm}^{(4)}$		-47		dB
		WiMAX 5-MHz carrier, $P_{out} = 0\text{ dBm}^{(4)}$		-45		dB
$f_{LO} = 3500\text{ MHz at } 8\text{ dBm}$						
G	Voltage gain	Output rms voltage over input I (or Q) rms voltage		0.6		dB
P1dB	Output compression point			13.5		dBm
IP3	Output IP3	$f_{BB} = 4.5, 5.5\text{ MHz}$		25		dBm
IP2	Output IP2	$f_{BB} = 4.5, 5.5\text{ MHz}$		65		dBm
	Carrier feedthrough	Unadjusted		-35		dBm
	Sideband suppression	Unadjusted; $f_{BB} = 4.5, 5.5\text{ MHz}$		-36		dBc
EVM	Error vector magnitude (rms)	WiMAX 5-MHz carrier, $P_{out} = -8\text{ dBm}^{(4)}$		-47		dB
		WiMAX 5-MHz carrier, $P_{out} = 0\text{ dBm}^{(4)}$		-43		dB
$f_{LO} = 4000\text{ MHz at } 8\text{ dBm}$						
G	Voltage gain	Output rms voltage over input I (or Q) rms voltage		0.2		dB
P1dB	Output compression point			12		dBm
IP3	Output IP3	$f_{BB} = 4.5, 5.5\text{ MHz}$		22.5		dBm
IP2	Output IP2	$f_{BB} = 4.5, 5.5\text{ MHz}$		60		dBm
	Carrier feedthrough	Unadjusted		-36		dBm
	Sideband suppression	Unadjusted; $f_{BB} = 4.5, 5.5\text{ MHz}$		-36		dBc
$f_{LO} = 5800\text{ MHz at } 4\text{ dBm}$						
G	Voltage gain	Output rms voltage over input I (or Q) rms voltage		-5.5		dB
P1dB	Output compression point			12.9		dBm
IP3	Output IP3	$f_{BB} = 4.5, 5.5\text{ MHz}$		25		dBm
IP2	Output IP2	$f_{BB} = 4.5, 5.5\text{ MHz}$		55		dBm
	Carrier feedthrough	Unadjusted		-31		dBm
	Sideband suppression	Unadjusted; $f_{BB} = 4.5, 5.5\text{ MHz}$		-36		dBc
EVM	Error-vector magnitude	WiMAX 5-MHz carrier, $P_{out} = -12\text{ dBm}^{(4)}$		-40		dB

(4) Sideband suppression optimized with LO drive level; EVM contribution from instrument is not accounted for.

6.7 Typical Characteristics

$V_{CM} = 1.7\text{ V}$, $V_{inBB} = 98\text{ mVrms}$ single-ended sine wave in quadrature, $V_{CC} = 5\text{ V}$, LO power = 4 dBm (single-ended), $f_{BB} = 50\text{ kHz}$ (unless otherwise noted).

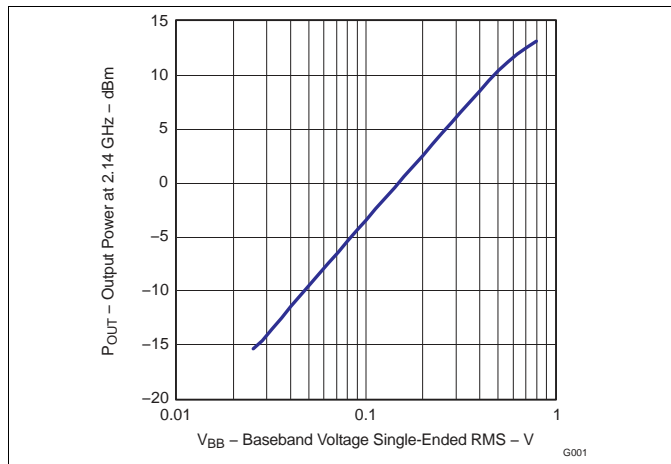

Figure 1. Output Power vs Baseband Voltage

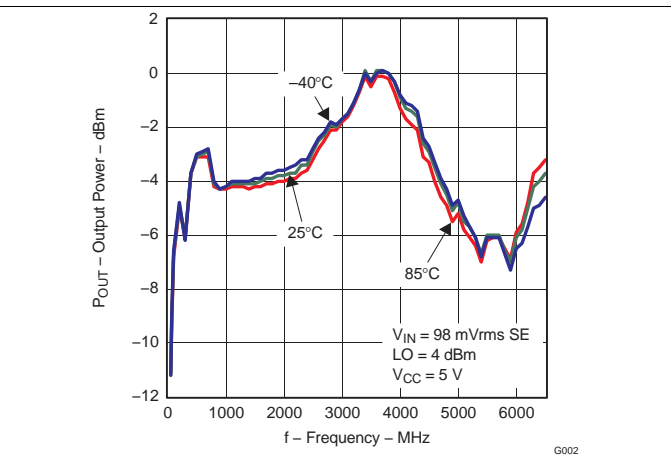

Figure 2. Output Power vs Frequency and Temperature

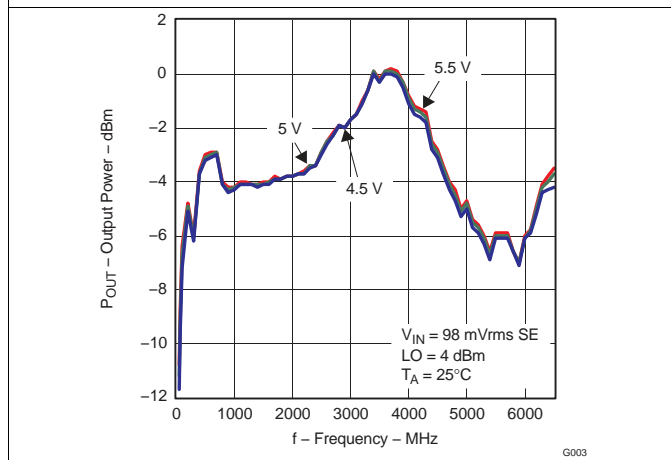

Figure 3. Output Power vs Frequency and Supply Voltage

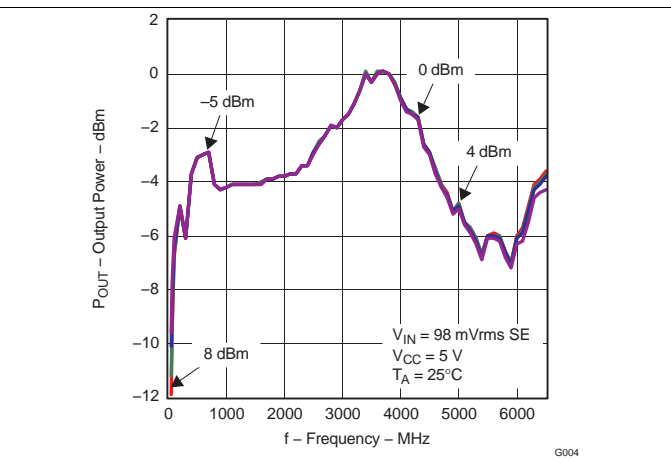

Figure 4. Output Power vs Frequency and LO Power

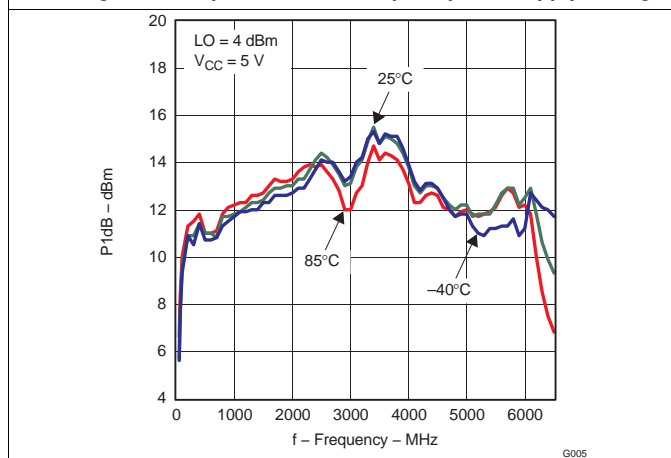

Figure 5. P1dB vs Frequency and Temperature

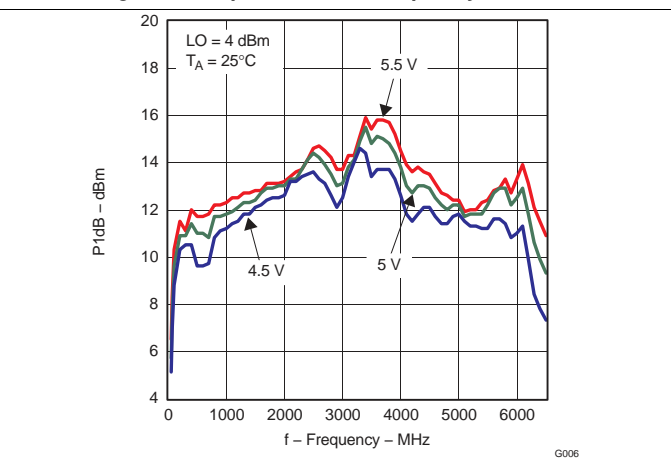

Figure 6. P1dB vs Frequency and Supply Voltage

Typical Characteristics (continued)

$V_{CM} = 1.7\text{ V}$, $V_{inBB} = 98\text{ mVrms}$ single-ended sine wave in quadrature, $V_{CC} = 5\text{ V}$, LO power = 4 dBm (single-ended), $f_{BB} = 50\text{ kHz}$ (unless otherwise noted).

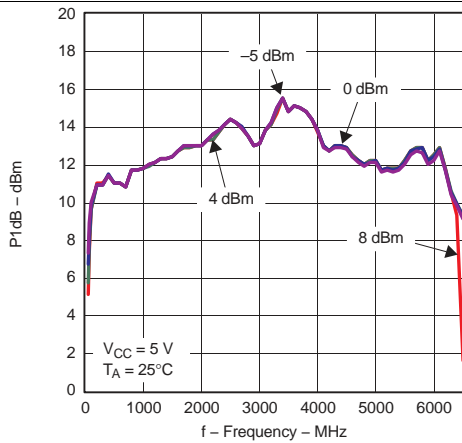

Figure 7. P1dB vs Frequency and LO Power

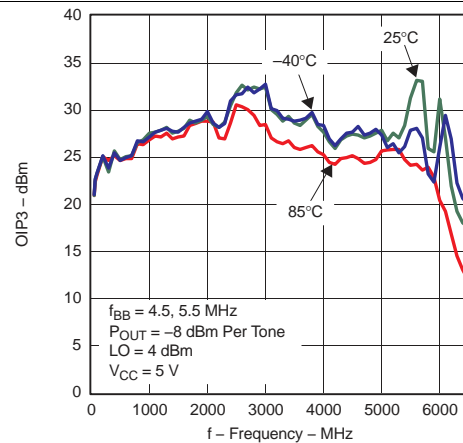

Figure 8. OIP3 vs Frequency and Temperature

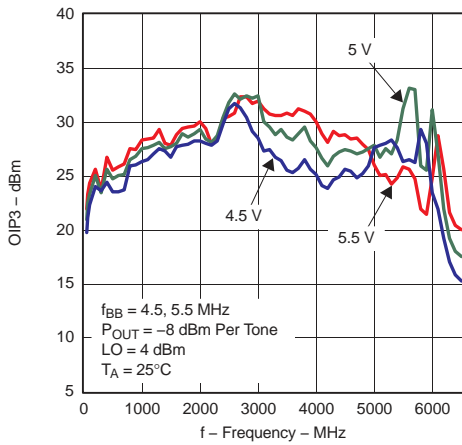

Figure 9. OIP3 vs Frequency and Supply Voltage

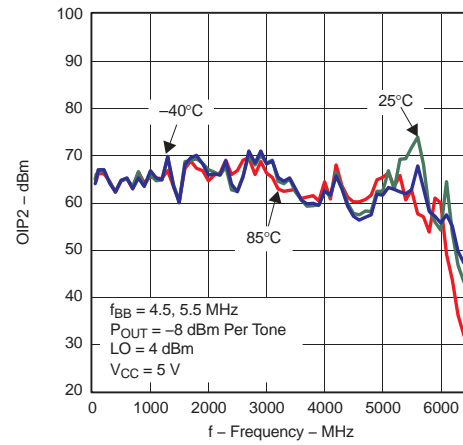

Figure 10. OIP2 vs Frequency and Temperature

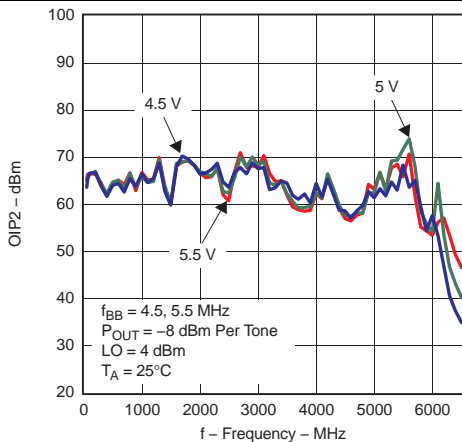

Figure 11. OIP2 vs Frequency and Supply Voltage

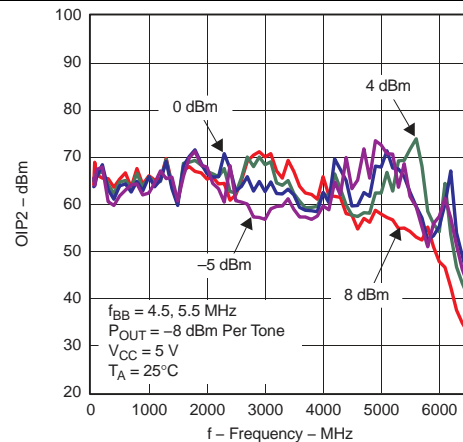

Figure 12. OIP2 vs Frequency and LO POWER

Typical Characteristics (continued)

$V_{CM} = 1.7\text{ V}$, $V_{inBB} = 98\text{ mVrms}$ single-ended sine wave in quadrature, $V_{CC} = 5\text{ V}$, LO power = 4 dBm (single-ended), $f_{BB} = 50\text{ kHz}$ (unless otherwise noted).

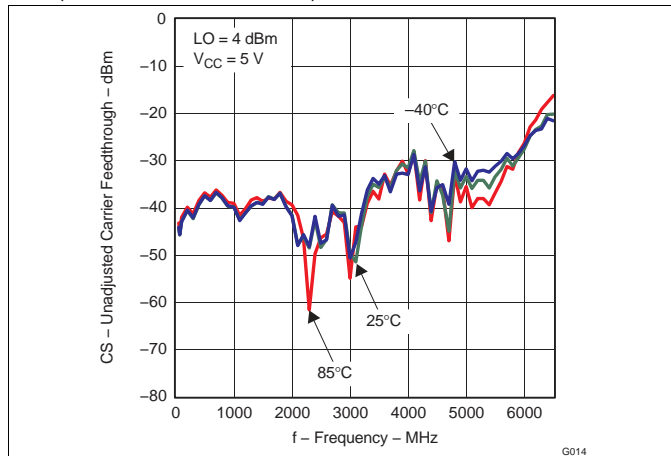

Figure 13. Unadjusted Carrier Feedthrough vs Frequency and Temperature

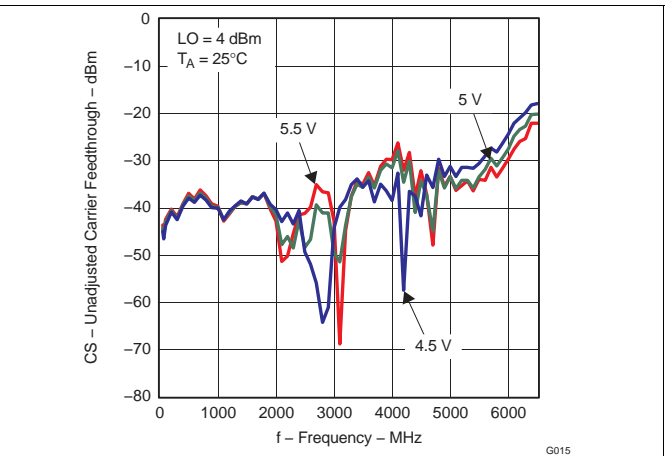

Figure 14. Unadjusted Carrier Feedthrough vs Frequency and Supply Voltage

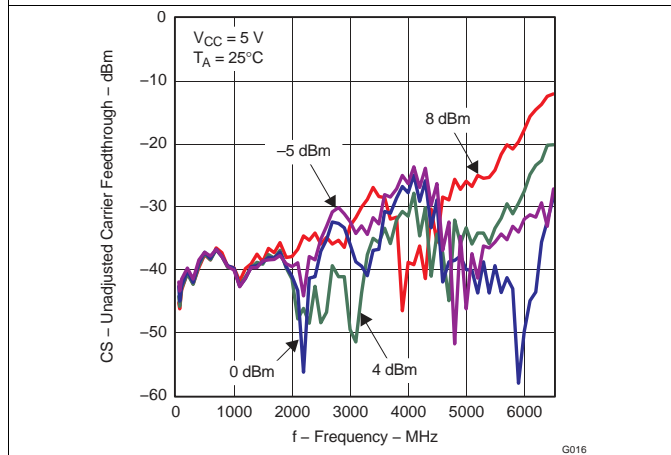

Figure 15. Unadjusted Carrier Feedthrough vs Frequency and LO Power

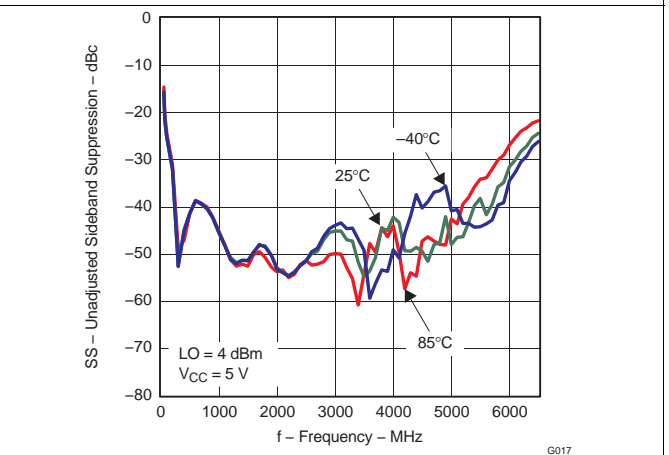

Figure 16. Unadjusted Sideband Suppression vs Frequency and Temperature

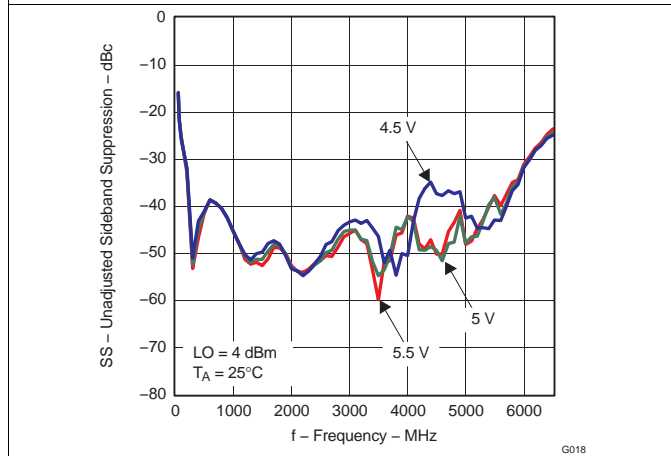

Figure 17. Unadjusted Sideband Suppression vs Frequency and Supply Voltage

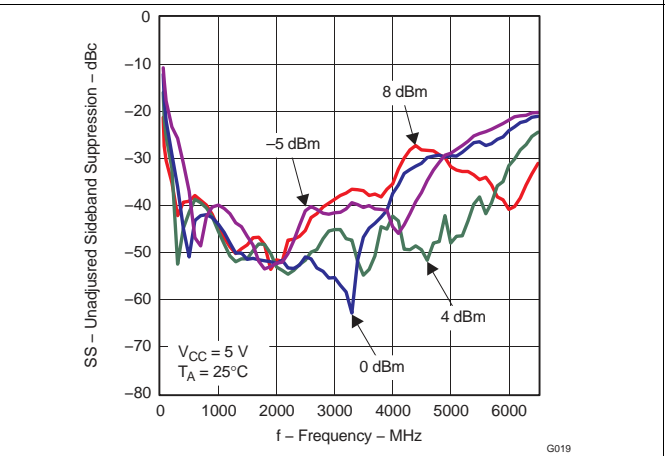

Figure 18. Unadjusted Sideband Suppression vs Frequency and LO Power

Typical Characteristics (continued)

$V_{CM} = 1.7\text{ V}$, $V_{inBB} = 98\text{ mVrms}$ single-ended sine wave in quadrature, $V_{CC} = 5\text{ V}$, LO power = 4 dBm (single-ended), $f_{BB} = 50\text{ kHz}$ (unless otherwise noted).

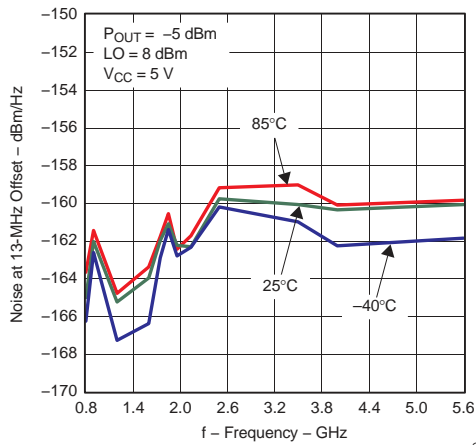

Figure 19. Noise at 13-MHz Offset (dBm/Hz) vs Frequency and Temperature

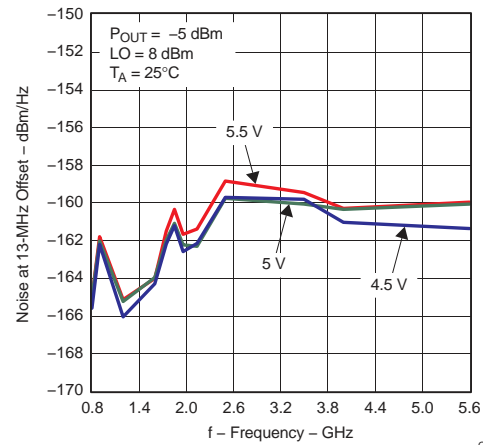

Figure 20. Noise at 13-MHz Offset (dBm/Hz) vs Frequency and Supply Voltage

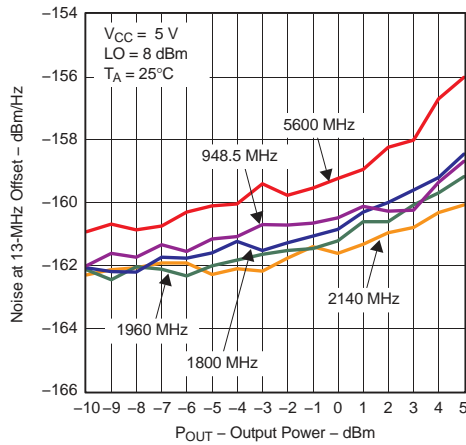

Figure 21. Noise at 13-MHz Offset (dBm/Hz) vs Output Power

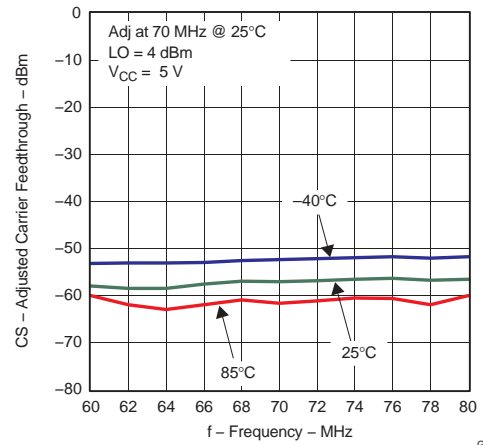

Figure 22. Adjusted Carrier Feedthrough vs Frequency and Temperature

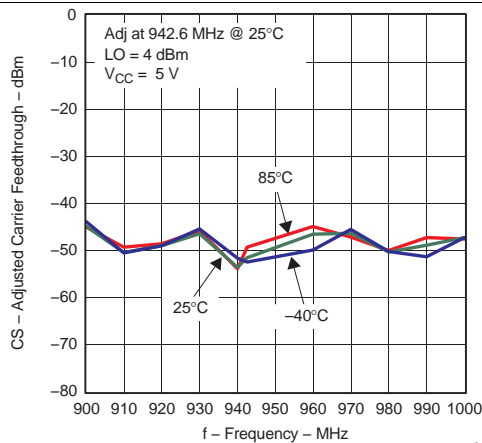

Figure 23. Adjusted Carrier Feedthrough vs Frequency and Temperature

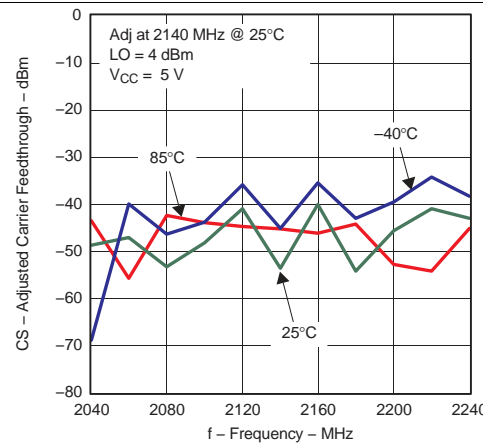

Figure 24. Adjusted Carrier Feedthrough vs Frequency and Temperature

Typical Characteristics (continued)

$V_{CM} = 1.7\text{ V}$, $V_{inBB} = 98\text{ mVrms}$ single-ended sine wave in quadrature, $V_{CC} = 5\text{ V}$, LO power = 4 dBm (single-ended), $f_{BB} = 50\text{ kHz}$ (unless otherwise noted).

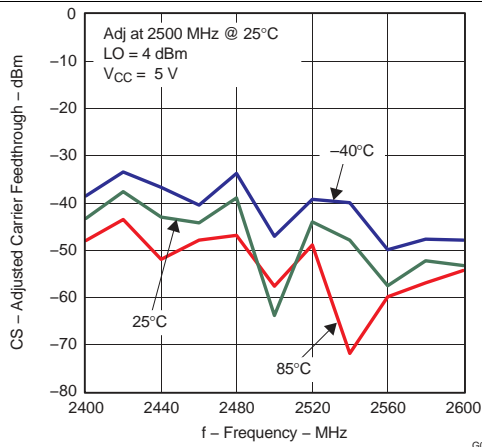

Figure 25. Adjusted Carrier Feedthrough vs Frequency and Temperature

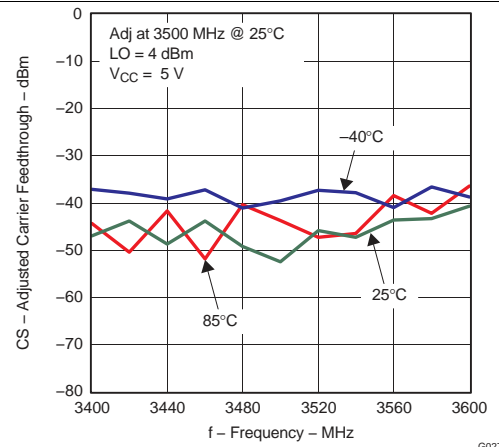

Figure 26. Adjusted Carrier Feedthrough vs Frequency and Temperature

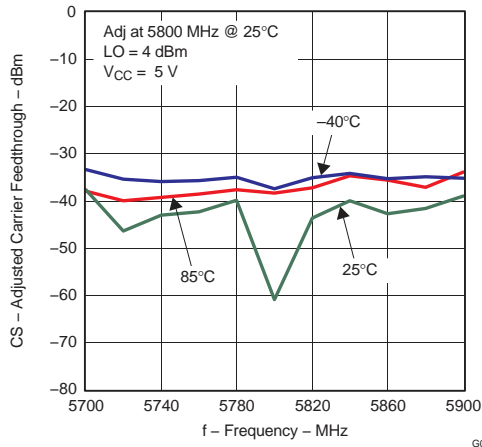

Figure 27. Adjusted Carrier Feedthrough vs Frequency and Temperature

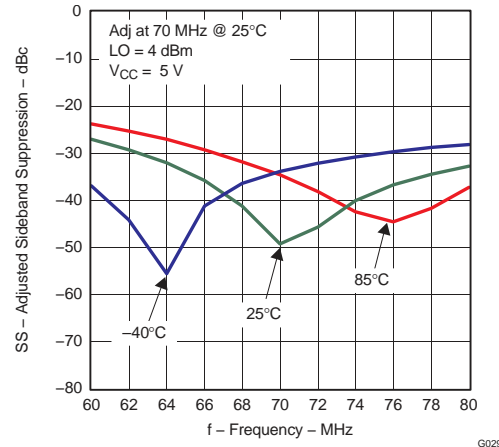

Figure 28. Adjusted Sideband Suppression vs Frequency and Temperature

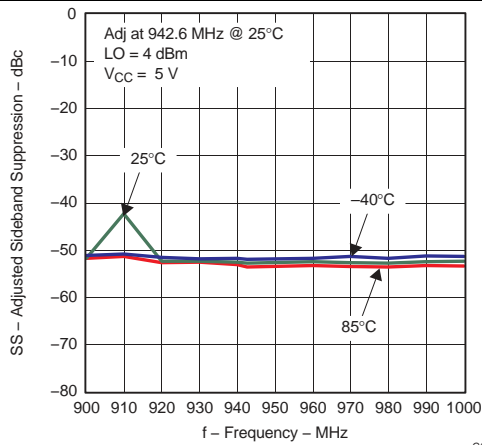

Figure 29. Adjusted Sideband Suppression vs Frequency and Temperature

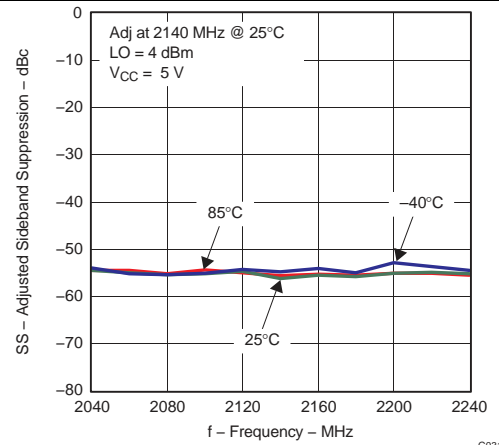

Figure 30. Adjusted Sideband Suppression vs Frequency and Temperature

Typical Characteristics (continued)

$V_{CM} = 1.7\text{ V}$, $V_{inBB} = 98\text{ mVrms}$ single-ended sine wave in quadrature, $V_{CC} = 5\text{ V}$, LO power = 4 dBm (single-ended), $f_{BB} = 50\text{ kHz}$ (unless otherwise noted).

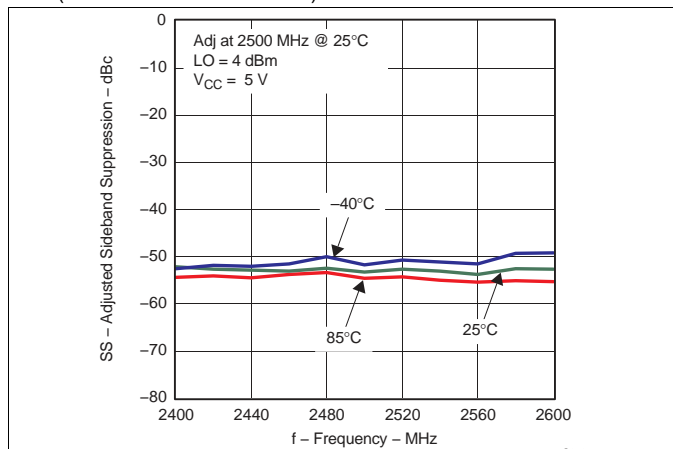

Figure 31. Adjusted Sideband Suppression vs Frequency and Temperature

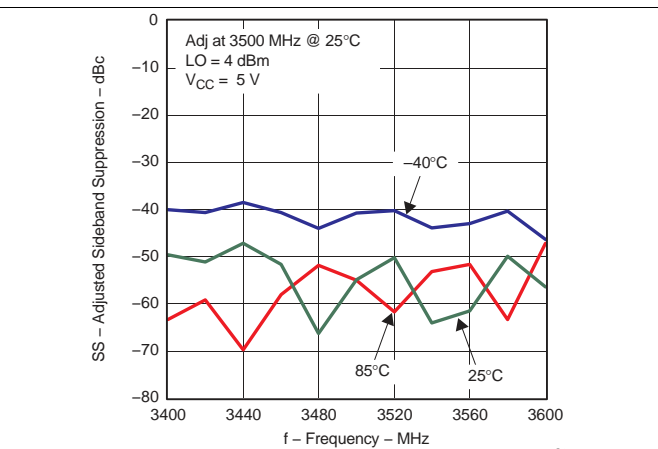

Figure 32. Adjusted Sideband Suppression vs Frequency and Temperature

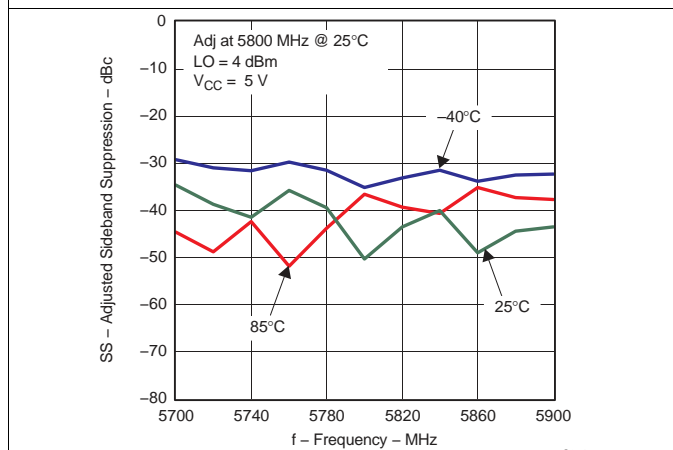

Figure 33. Adjusted Sideband Suppression vs Frequency and Temperature

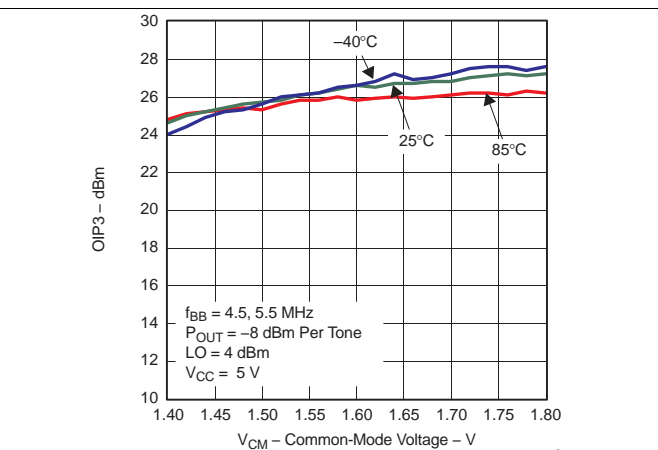

Figure 34. OIP3 vs Common-Mode Voltage at 948.5 MHz

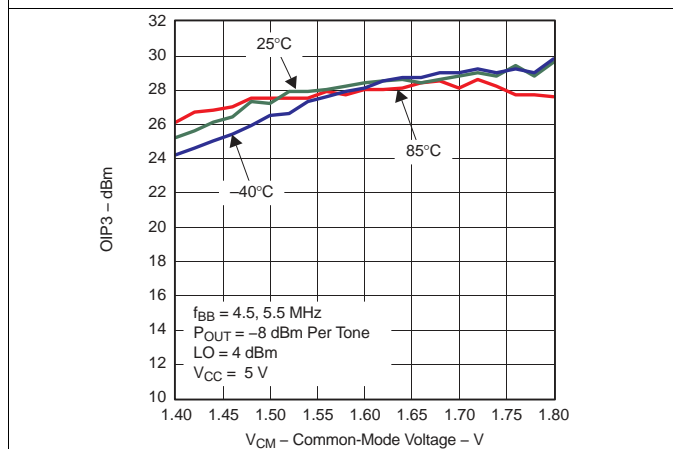

Figure 35. OIP3 vs Common-Mode Voltage at 1800 MHz

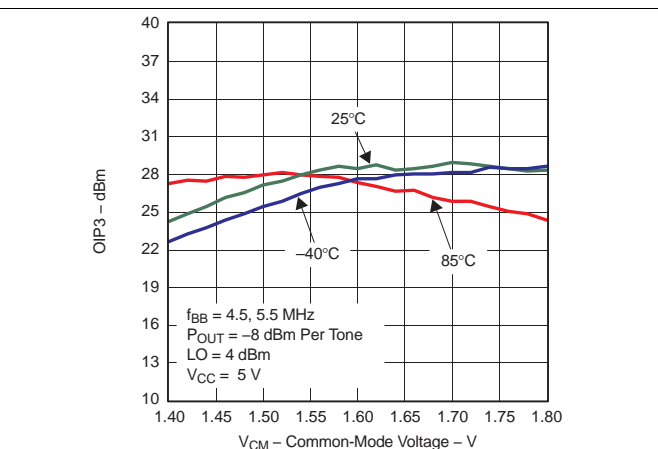

Figure 36. OIP3 vs Common-Mode Voltage at 2140 MHz

Typical Characteristics (continued)

$V_{CM} = 1.7\text{ V}$, $V_{inBB} = 98\text{ mVrms}$ single-ended sine wave in quadrature, $V_{CC} = 5\text{ V}$, LO power = 4 dBm (single-ended), $f_{BB} = 50\text{ kHz}$ (unless otherwise noted).

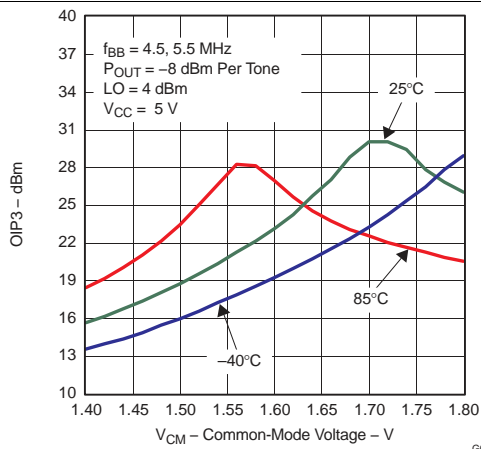

Figure 37. OIP3 vs Common-Mode Voltage at 5800 MHz

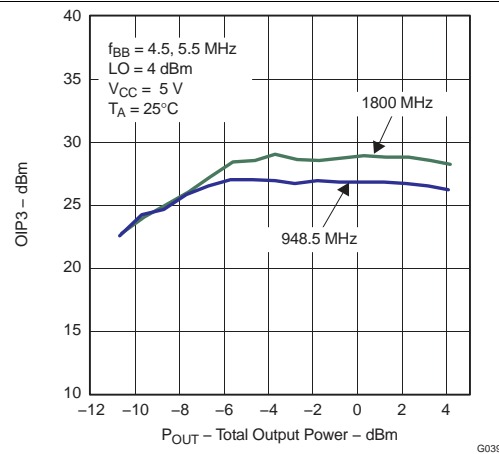

Figure 38. OIP3 vs Total Output Power

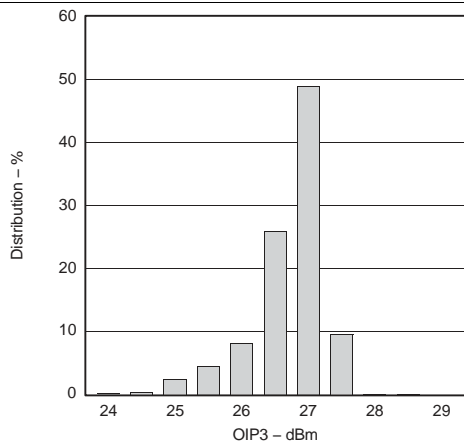

Figure 39. OIP3 at 1960 MHz Distribution

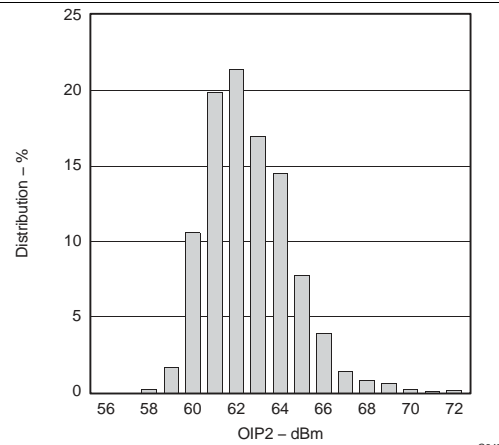

Figure 40. OIP2 at 1960 MHz Distribution

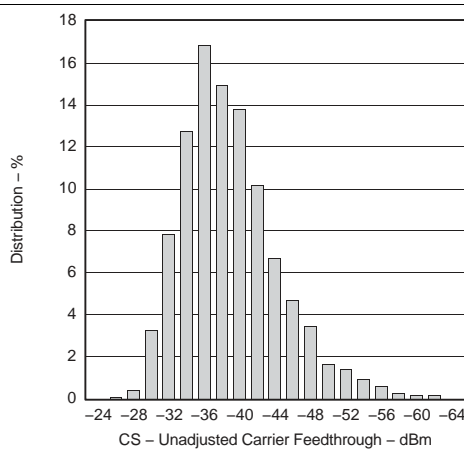

Figure 41. Unadjusted Carrier Feedthrough at 1960 MHz Distribution

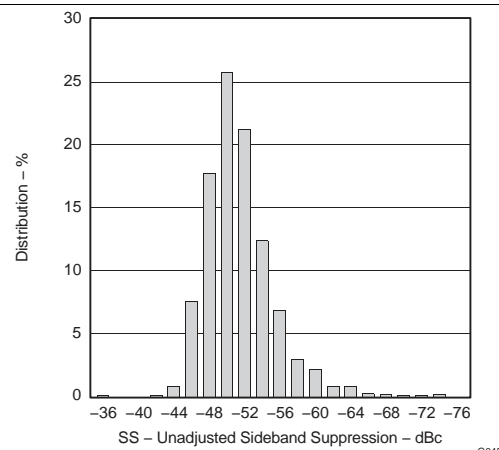

Figure 42. Unadjusted Sideband Suppression at 1960 MHz Distribution

Typical Characteristics (continued)

$V_{CM} = 1.7\text{ V}$, $V_{inBB} = 98\text{ mVrms}$ single-ended sine wave in quadrature, $V_{CC} = 5\text{ V}$, LO power = 4 dBm (single-ended), $f_{BB} = 50\text{ kHz}$ (unless otherwise noted).

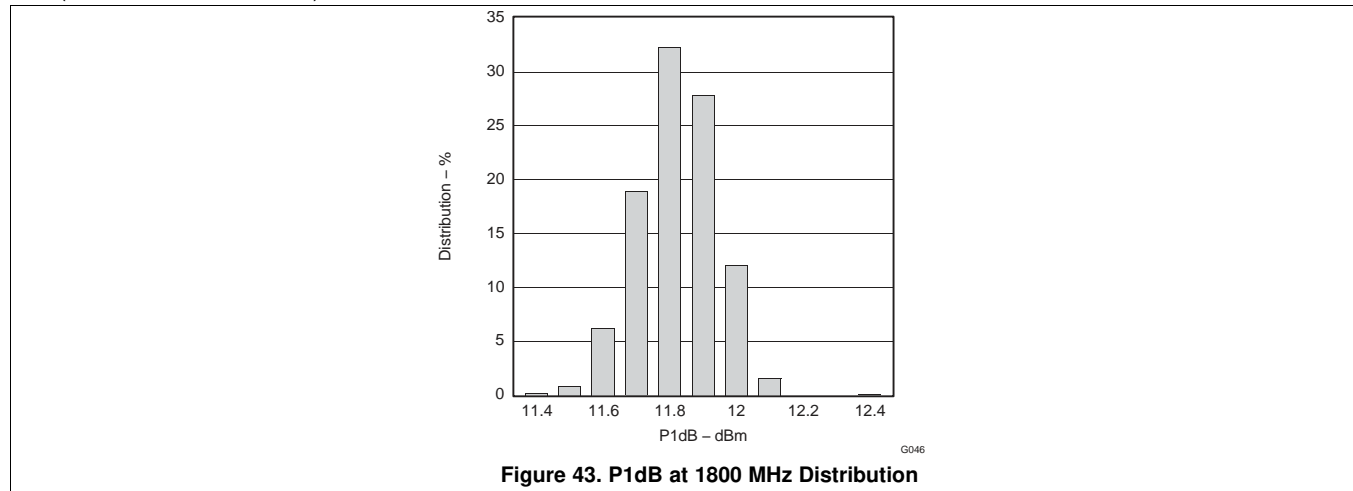

Figure 43. P1dB at 1800 MHz Distribution

7 Detailed Description

7.1 Overview

TRF370417 is a low-noise direct quadrature modulator with high linearity, capable of converting complex modulated signals from baseband or IF directly to RF. With high-performance and superior-linearity, the TRF370417 is an ideal device to up-convert to RF frequencies from 50-MHz through 6-GHz. The baseband inputs can support an input bandwidth up to 1-GHz. The modulator is implemented as a double-balanced mixer. The RF output block contains a differential to single-ended converter to drive a 50-ohm load without the need for external matching components. The baseband input common-mode voltage is set at 1.7-V for optimum linearity performance.

7.2 Functional Block Diagram

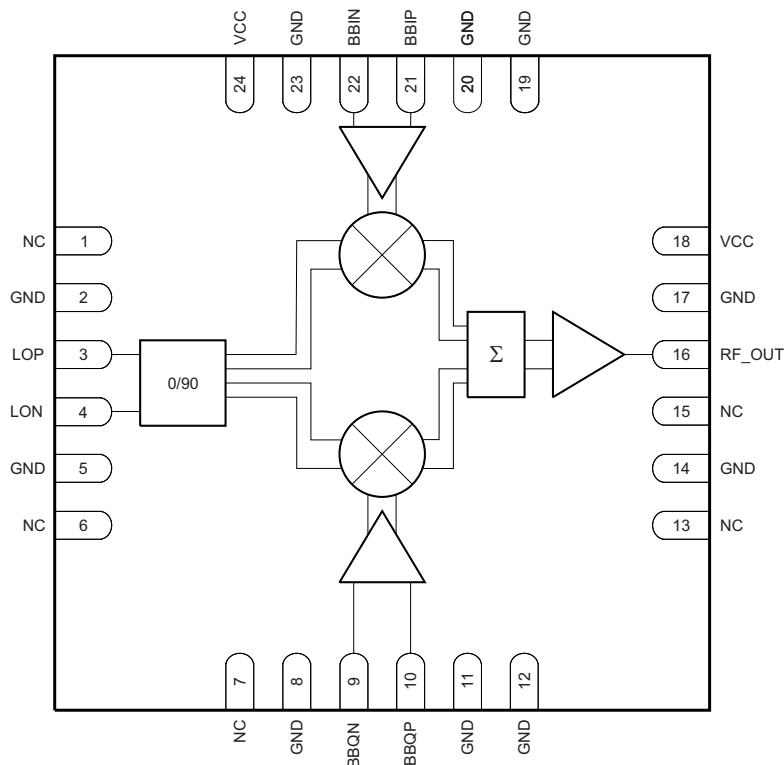

B0175-01

NOTE: NC = No connection

7.3 Feature Description

TRF370417 supports an I/Q baseband input bandwidth of 1-GHz. With this bandwidth capability the input signal can be centered at a high IF frequency to provide frequency separation from unwanted carrier feed-through or sideband image. Utilizing the full baseband bandwidth yields an RF output bandwidth up to 2-GHz.

7.4 Device Functional Modes

7.4.1 Baseband Common-Mode Voltage

TRF370417 input baseband pins operate around a common-mode voltage of 1.7-V. Variation around this common-mode is possible but best linearity performance is generally achieved when kept at nominal voltage.

Device Functional Modes (continued)

7.4.2 LO Drive Level

The LO drive level is nominally specified at 4-dBm. The device can accept a large range of LO drive level. A higher drive level generally provides better output noise performance and some linearity improvement. There is some trade-off between carrier feed-through and sideband suppression performance that is dependent on frequency and drive level. The LO drive level of 4-dB is deemed a good balance between those two parameters across frequency.

8 Application and Implementation

NOTE

Information in the following applications sections is not part of the TI component specification, and TI does not warrant its accuracy or completeness. TI's customers are responsible for determining suitability of components for their purposes. Customers should validate and test their design implementation to confirm system functionality.

8.1 Application Information

8.1.1 Basic Connections

- See [Figure 44](#) for proper connection of the TRF3704 modulator.
- Connect a single power supply (4.5 V–5.5 V) to pins 18 and 24. These pins should be decoupled as shown on pins 4, 5, 6, and 7.
- Connect pins 2, 5, 8, 11, 12, 14, 17, 19, 20, and 23 to GND.
- Connect a single-ended LO source of desired frequency to LOP (amplitude between –5 dBm and 12 dBm). This should be ac-coupled through a 100-pF capacitor.
- Terminate the ac-coupled LON with 50 Ω to GND.
- Connect a baseband signal to pins 21 = I, 22 = \bar{I} , 10 = Q, and 9 = \bar{Q} .
- The differential baseband inputs should be set to the proper common-mode voltage of 1.7 V.
- RF_OUT, pin 16, can be fed to a spectrum analyzer set to the desired frequency, LO \pm baseband signal. This pin should also be ac-coupled through a 100-pF capacitor.
- All NC pins can be left floating.

8.1.1.1 ESD Sensitivity

RF devices may be extremely sensitive to electrostatic discharge (ESD). To prevent damage from ESD, devices should be stored and handled in a way that prevents the build-up of electrostatic voltages that exceed the rated level. Rated ESD levels should also not be exceeded while the device is installed on a printed circuit board (PCB). Follow these guidelines for optimal ESD protection:

- Low ESD performance is not uncommon in RF ICs; see the [Absolute Maximum Ratings](#) table. Therefore, customers' ESD precautions should be consistent with these ratings.
- The device should be robust once assembled onto the PCB **unless** external inputs (connectors, etc.) directly connect the device pins to off-board circuits.

Application Information (continued)

8.1.3 WCDMA Applications

The TRF370417 is also optimized for WCDMA applications where both adjacent-channel power ratio (ACPR) and noise density are critically important. Using Texas instruments' DAC568X series of high-performance digital-to-analog converters as depicted in Figure 44, excellent ACPR levels were measured with one-, two-, and four-WCDMA carriers. See *Electrical Characteristics*, $f_{LO} = 1960$ MHz and $f_{LO} = 2140$ MHz for exact ACPR values.

8.2 Typical Application

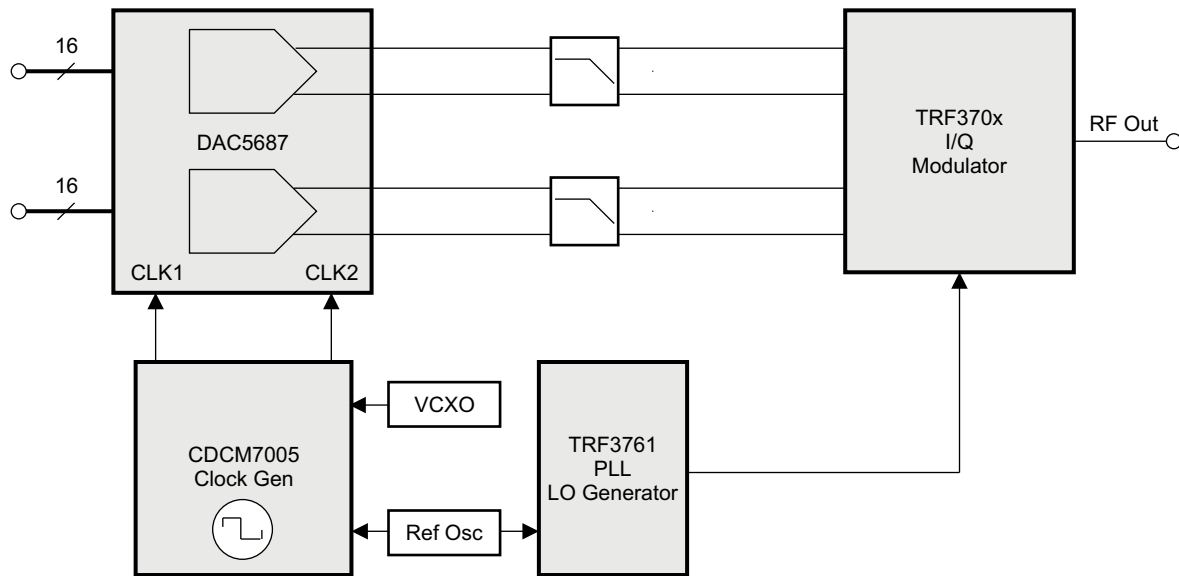

B0176-02

Figure 45. Typical Transmit Setup Block Diagram

8.2.1 Design Requirements

Table 1 lists the requirements and limitations for pin termination.

Table 1. Pin Termination Requirements and Limitations

NAME	PIN NO.	DESCRIPTION
BBQM	9	Baseband in-quadrature input: negative terminal. Optimal linearity is obtained if VCM is 1.7-V. Normally terminated in 50 Ω
BBQP	10	Baseband in-quadrature input: positive terminal. Optimal linearity is obtained if VCM is 1.7-V. Normally terminated in 50 Ω
BBIP	21	Baseband in-phase input: positive terminal. Optimal linearity is obtained if VCM is 1.7-V. Normally terminated in 50 Ω
BBIM	22	Baseband in-phase input: negative terminal. Optimal linearity is obtained if VCM is 1.7-V. Normally terminated in 50 Ω
LOP	3	Local oscillator input: positive terminal. This is preferred port when driving single ended. Normally AC coupled and terminated in 50 Ω
LOM	4	Local oscillator input: negative terminal. When driving LO single-ended, normally AC coupled and terminated in 50 Ω.
RFOUT	16	RF output. Normally AC coupled. Recommend to terminate with broadband 50- Ω load.
VCC	18, 24	5.0-V power supply. Can be tied together and sourced from a single clean supply. Each pin should be properly RF bypassed.

8.2.2 Detailed Design Procedure

Table 2. Bill of Materials for TRF370x EVM

ITEM NUMBER	QUANTITY	REFERENCE DESIGNATOR	VALUE	PCB FOOTPRINT	MFR. NAME	MFT. PART NUMBER	NOTE
1	3	C1, C2, C3	100 pF	0402	PANASONIC	ECJ-0EC1H101J	
2	2	C4, C5	1000 pF	0402	PANASONIC	ECJ-0VC1H102J	
3	2	C6, C7	4.7 μ F	TANT_A	KERMET	T491A475K016AS	
4	0	C8, C9	1 μ F	0402	PANASONIC	ECJ-0EC1H010C_DNI	DNI
5	0	C10, C11, C12, C13	0.1 μ F	0402	PANASONIC	ECJ-0EB1A104K_DNI	DNI
6	2	C14, C15	10 pF	0402	MURATA	GRM1555C1H100JZ01D	
7	7	J1, J2, J3, J4, J5, J6, J7	LOP	SMA_SMEL_250x215	JOHNSON COMPONENTS	142-0711-821	
8	2	R1	0	0402	PANASONIC	ERJ-2GE0R00	OR EQUIVALENT
9	4	R2, R3, R4, R5	0	0402	PANASONIC	ERJ-2GE0R00	OR EQUIVALENT
10	1	U1	TRF370333	QFN_24_163x163_0p50mm	TI	TRF370333	For TRF370333 EVM, TI supplied
			TRF370317	QFN_24_163x163_0p50mm	TI	TRF370317	For TRF370317 EVM, TI supplied
			TRF370315	QFN_24_163x163_0p50mm	TI	TRF370315	For TRF370315 EVM, TI supplied
			TRF370417	QFN_24_163x163_0p50mm	TI	TRF370417	For TRF370417 EVM, TI supplied
11	2	TP1, TP3	BLK	TP_THVT_100_RND	KEYSTONE	5001K	
12	2	TP2, TP4	RED	TP_THVT_100_RND	KEYSTONE	5000K	

8.2.2.1 DAC-to-Modulator Interface Network

For optimum linearity and dynamic range, the digital-to-analog converter (DAC) can interface directly with the modulator; however, the common-mode voltage of each device must be maintained. A passive interface circuit is used to transform the common-mode voltage of the DAC to the desired set-point of the modulator. The passive circuit invariably introduces some insertion loss between the two devices. In general, it is desirable to keep the insertion loss as low as possible to achieve the best dynamic range. [Figure 46](#) shows the passive interconnect circuit for two different topologies. One topology is used when the DAC (such as the DAC568x) common-mode is larger than the modulator. The voltage V_{ee} is nominally set to ground, but can be set to a negative voltage to reduce the insertion loss of the network. The second topology is used when the DAC (such as the DAC56x2) common-mode is smaller than the modulator. Note that this passive interconnect circuit is duplicated for each of the differential I/Q branches.

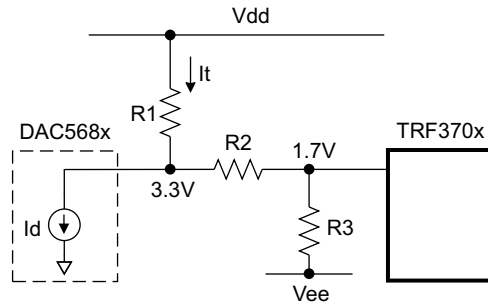

Topology 1: DAC Vcm > TRF370x Vcm

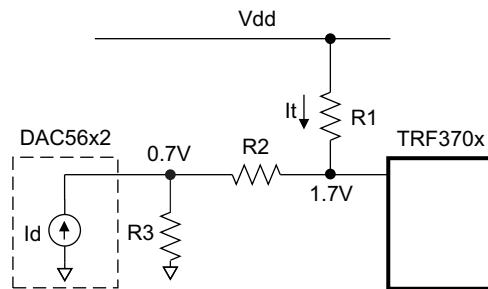

Topology 2: DAC Vcm < TRF370x Vcm

S0338-01

Figure 46. Passive DAC-to-Modulator Interface Network

Table 3. DAC-to-Modulator Interface Network Values

	TOPOLOGY 1		TOPOLOGY 2
	WITH VEE = 0 V	WITH VEE = 5 V	
DAC Vcm [V]	3.3	3.3	0.7
TRF370x Vcm [V]	1.7	1.7	1.7
Vdd [V]	5	5	5
Vee [V]	Gnd	-5	N/A
R1 [Ω]	66	56	960
R2 [Ω]	100	80	290
R3 [Ω]	108	336	52
Insertion loss [dB]	5.8	1.9	2.3

8.2.3 Application Curves

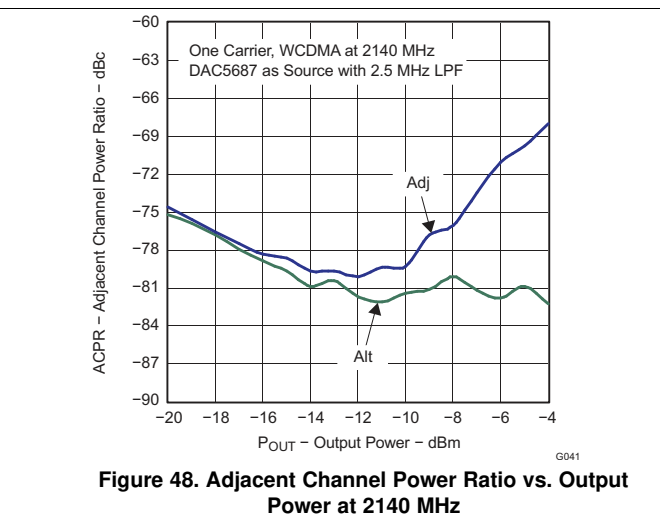
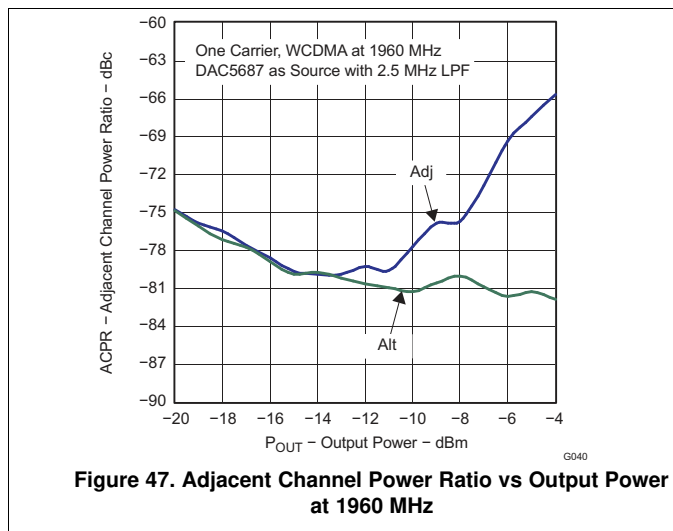

9 Power Supply Recommendations

The TRF370417 is powered by supplying a nominal 5 V to pins 18 and 24. These supplies can be tied together and sourced from a single clean supply. Proper RF bypassing should be placed close to each power supply pin. Ground pin connections should have at least one ground via close to each ground pin to minimize ground inductance. The thermal pad must be tied to ground, preferably with the recommended ground via pattern to provide a good thermal conduction path to the alternate side of the board and to provide a good RF ground for the device. (Refer to [Layout Guidelines](#) for additional information.)

10 Layout

10.1 Layout Guidelines

The TRF370417 device is fitted with a ground slug on the back of the package that must be soldered to the printed circuit board (PCB) ground with adequate ground vias to ensure a good thermal and electrical connection. The recommended via pattern and ground pad dimensions are shown in Figure 76. The recommended via diameter is 10 mils (0.10 in or 0.25 mm). The ground pins of the device can be directly tied to the ground slug pad for a low-inductance path to ground. Additional ground vias may be added if space allows. Decoupling capacitors at each of the supply pins are strongly recommended. The value of these capacitors should be chosen to provide a low-impedance RF path to ground at the frequency of operation. Typically, the value of these capacitors is approximately 10 pF or lower. The device exhibits symmetry with respect to the quadrature input paths. TI recommends that the PCB layout maintain this symmetry to ensure that the quadrature balance of the device is not impaired. The I/Q input traces should be routed as differential pairs and the respective lengths all kept equal to each other. On the RF traces, maintain proper trace widths to keep the characteristic impedance of the RF traces at a nominal 50 Ω.

10.2 Layout Example

Figure 49 shows the top view of the TRF3704 EVM board.

Layout Example (continued)

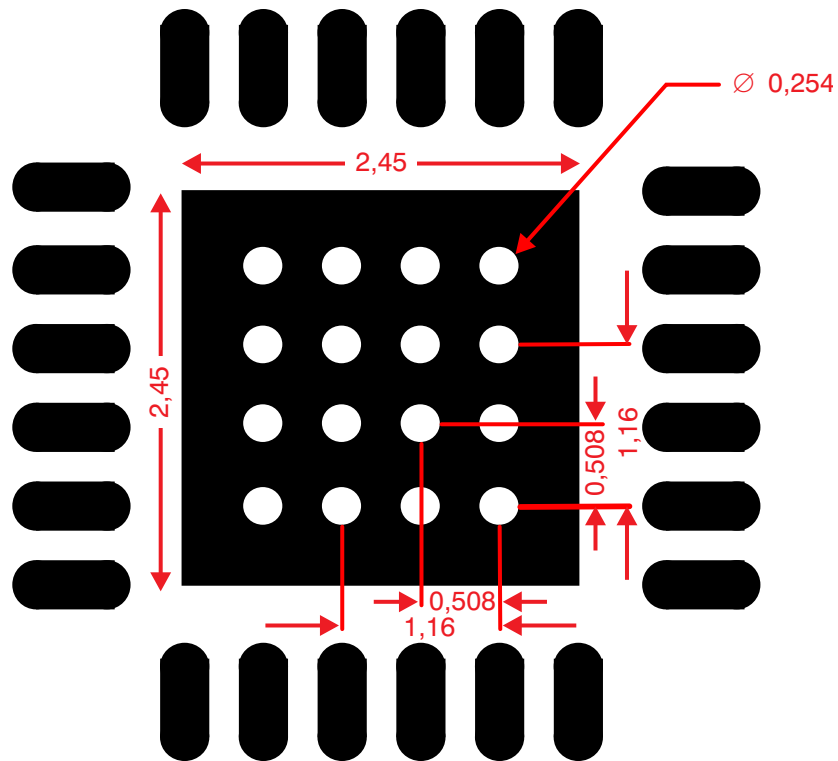

Figure 49. PCB Via Ground Layout Guide

11 Device and Documentation Support

11.1 Device Support

11.1.1 Device Nomenclature

Adjusted (Optimized) Carrier Feedthrough This differs from the unadjusted suppression number in that the baseband input dc offsets are iteratively adjusted around their theoretical value of VCM to yield the maximum suppression of the LO component in the output spectrum. This is measured in dBm.

Adjusted (Optimized) Sideband Suppression This differs from the unadjusted sideband suppression in that the gain and phase of the baseband inputs are iteratively adjusted around their theoretical values to maximize the amount of sideband suppression. This is measured in dBc.

Suppressions Over Temperature This specification assumes that the user has gone through the optimization process for the suppression in question, and set the optimal settings for the I, Q inputs. This specification then measures the suppression when temperature conditions change after the initial calibration is done.

Figure 50 shows a simulated output and illustrates the respective definitions of various terms used in this data sheet.

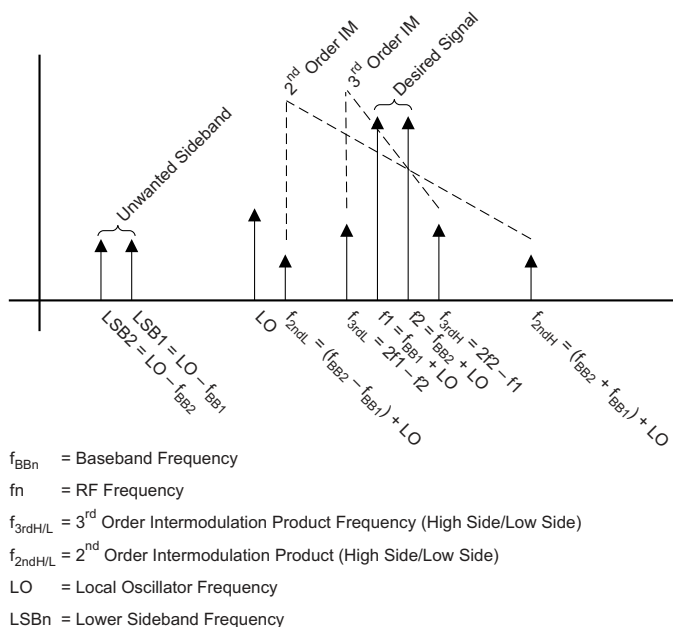

Figure 50. Graphical Illustration of Common Terms

Unadjusted Carrier Feedthrough This specification measures the amount by which the local oscillator component is suppressed in the output spectrum of the modulator. If the common-mode voltage at each of the baseband inputs is exactly the same and there was no dc imbalance introduced by the modulator, the LO component would be naturally suppressed. DC offset imbalances in the device allow some of the LO component to feed through to the output. Because this phenomenon is independent of the RF output power and the injected LO input power, the parameter is expressed in absolute power, dBm.

Unadjusted Sideband Suppression This specification measures the amount by which the unwanted sideband of the input signal is suppressed in the output of the modulator, relative to the wanted sideband. If the amplitude and phase within the I and Q branch of the modulator were perfectly matched, the unwanted sideband (or image) would be naturally suppressed. Amplitude and phase imbalance in the I and Q branches results in the increase of the unwanted sideband. This parameter is measured in dBc relative to the desired sideband.

11.2 Documentation Support

11.2.1 Related Documentation

For related documentation, see the documents that follow:

- [TRF370x User's Guide](#)
- [TRF370417: Optimizing OIP3 Performance at Local Oscillator \(LO\) Frequencies Beyond 4.5 GHz](#)
- [High Bandwidth, High Frequency Transmitter Reference Design](#)

11.3 Community Resources

The following links connect to TI community resources. Linked contents are provided "AS IS" by the respective contributors. They do not constitute TI specifications and do not necessarily reflect TI's views; see TI's [Terms of Use](#).

TI E2E™ Online Community *TI's Engineer-to-Engineer (E2E) Community*. Created to foster collaboration among engineers. At e2e.ti.com, you can ask questions, share knowledge, explore ideas and help solve problems with fellow engineers.

Design Support *TI's Design Support* Quickly find helpful E2E forums along with design support tools and contact information for technical support.

11.4 Trademarks

E2E is a trademark of Texas Instruments.
All other trademarks are the property of their respective owners.

11.5 Electrostatic Discharge Caution



These devices have limited built-in ESD protection. The leads should be shorted together or the device placed in conductive foam during storage or handling to prevent electrostatic damage to the MOS gates.

11.6 Glossary



[SLYZ022](#) — *TI Glossary*.

This glossary lists and explains terms, acronyms, and definitions.

12 Mechanical, Packaging, and Orderable Information

The following pages include mechanical, packaging, and orderable information. This information is the most current data available for the designated devices. This data is subject to change without notice and revision of this document. For browser-based versions of this data sheet, refer to the left-hand navigation.

PACKAGING INFORMATION

Orderable Device	Status (1)	Package Type	Package Drawing	Pins	Package Qty	Eco Plan (2)	Lead finish/ Ball material (6)	MSL Peak Temp (3)	Op Temp (°C)	Device Marking (4/5)	Samples
TRF370417IRGER	ACTIVE	VQFN	RGE	24	3000	RoHS & Green	NIPDAU	Level-2-260C-1 YEAR	-40 to 85	TRF37 0417	
TRF370417IRGET	ACTIVE	VQFN	RGE	24	250	RoHS & Green	NIPDAU	Level-2-260C-1 YEAR	-40 to 85	TRF37 0417	

(1) The marketing status values are defined as follows:

ACTIVE: Product device recommended for new designs.

LIFEBUY: TI has announced that the device will be discontinued, and a lifetime-buy period is in effect.

NRND: Not recommended for new designs. Device is in production to support existing customers, but TI does not recommend using this part in a new design.

PREVIEW: Device has been announced but is not in production. Samples may or may not be available.

OBsolete: TI has discontinued the production of the device.

(2) **RoHS:** TI defines "RoHS" to mean semiconductor products that are compliant with the current EU RoHS requirements for all 10 RoHS substances, including the requirement that RoHS substance do not exceed 0.1% by weight in homogeneous materials. Where designed to be soldered at high temperatures, "RoHS" products are suitable for use in specified lead-free processes. TI may reference these types of products as "Pb-Free".

RoHS Exempt: TI defines "RoHS Exempt" to mean products that contain lead but are compliant with EU RoHS pursuant to a specific EU RoHS exemption.

Green: TI defines "Green" to mean the content of Chlorine (Cl) and Bromine (Br) based flame retardants meet JS709B low halogen requirements of <=1000ppm threshold. Antimony trioxide based flame retardants must also meet the <=1000ppm threshold requirement.

(3) MSL, Peak Temp. - The Moisture Sensitivity Level rating according to the JEDEC industry standard classifications, and peak solder temperature.

(4) There may be additional marking, which relates to the logo, the lot trace code information, or the environmental category on the device.

(5) Multiple Device Markings will be inside parentheses. Only one Device Marking contained in parentheses and separated by a "~" will appear on a device. If a line is indented then it is a continuation of the previous line and the two combined represent the entire Device Marking for that device.

(6) Lead finish/Ball material - Orderable Devices may have multiple material finish options. Finish options are separated by a vertical ruled line. Lead finish/Ball material values may wrap to two lines if the finish value exceeds the maximum column width.

Important Information and Disclaimer:The information provided on this page represents TI's knowledge and belief as of the date that it is provided. TI bases its knowledge and belief on information provided by third parties, and makes no representation or warranty as to the accuracy of such information. Efforts are underway to better integrate information from third parties. TI has taken and continues to take reasonable steps to provide representative and accurate information but may not have conducted destructive testing or chemical analysis on incoming materials and chemicals. TI and TI suppliers consider certain information to be proprietary, and thus CAS numbers and other limited information may not be available for release.

In no event shall TI's liability arising out of such information exceed the total purchase price of the TI part(s) at issue in this document sold by TI to Customer on an annual basis.

TAPE AND REEL INFORMATION



QUADRANT ASSIGNMENTS FOR PIN 1 ORIENTATION IN TAPE



*All dimensions are nominal

Device	Package Type	Package Drawing	Pins	SPQ	Reel Diameter (mm)	Reel Width W1 (mm)	A0 (mm)	B0 (mm)	K0 (mm)	P1 (mm)	W (mm)	Pin1 Quadrant
TRF370417IRGER	VQFN	RGE	24	3000	330.0	12.4	4.3	4.3	1.5	8.0	12.0	Q1
TRF370417IRGET	VQFN	RGE	24	250	330.0	12.4	4.3	4.3	1.5	8.0	12.0	Q1

TAPE AND REEL BOX DIMENSIONS

*All dimensions are nominal

Device	Package Type	Package Drawing	Pins	SPQ	Length (mm)	Width (mm)	Height (mm)
TRF370417IRGER	VQFN	RGE	24	3000	367.0	367.0	38.0
TRF370417IRGET	VQFN	RGE	24	250	367.0	367.0	38.0

GENERIC PACKAGE VIEW

RGE 24

VQFN - 1 mm max height

PLASTIC QUAD FLATPACK - NO LEAD

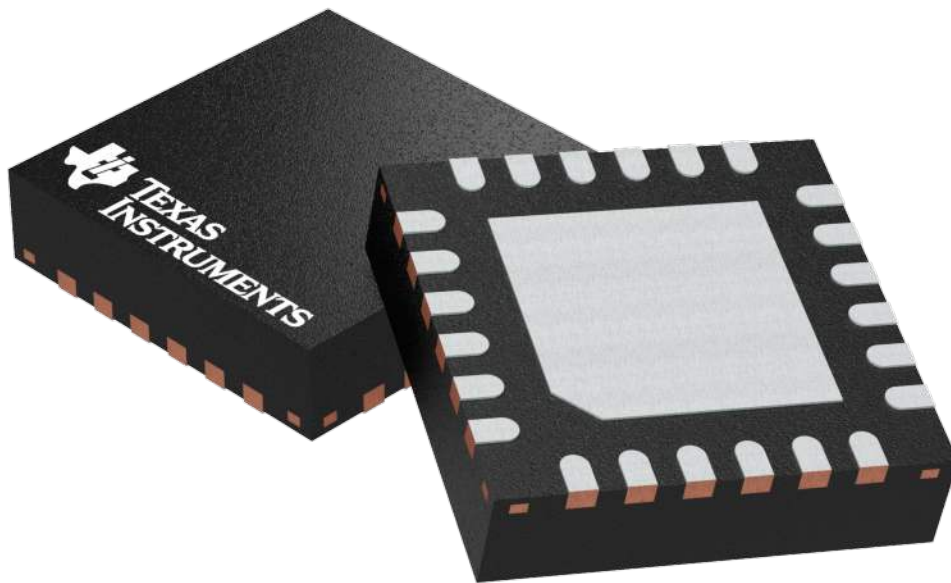

Images above are just a representation of the package family, actual package may vary.
Refer to the product data sheet for package details.

4204104/H

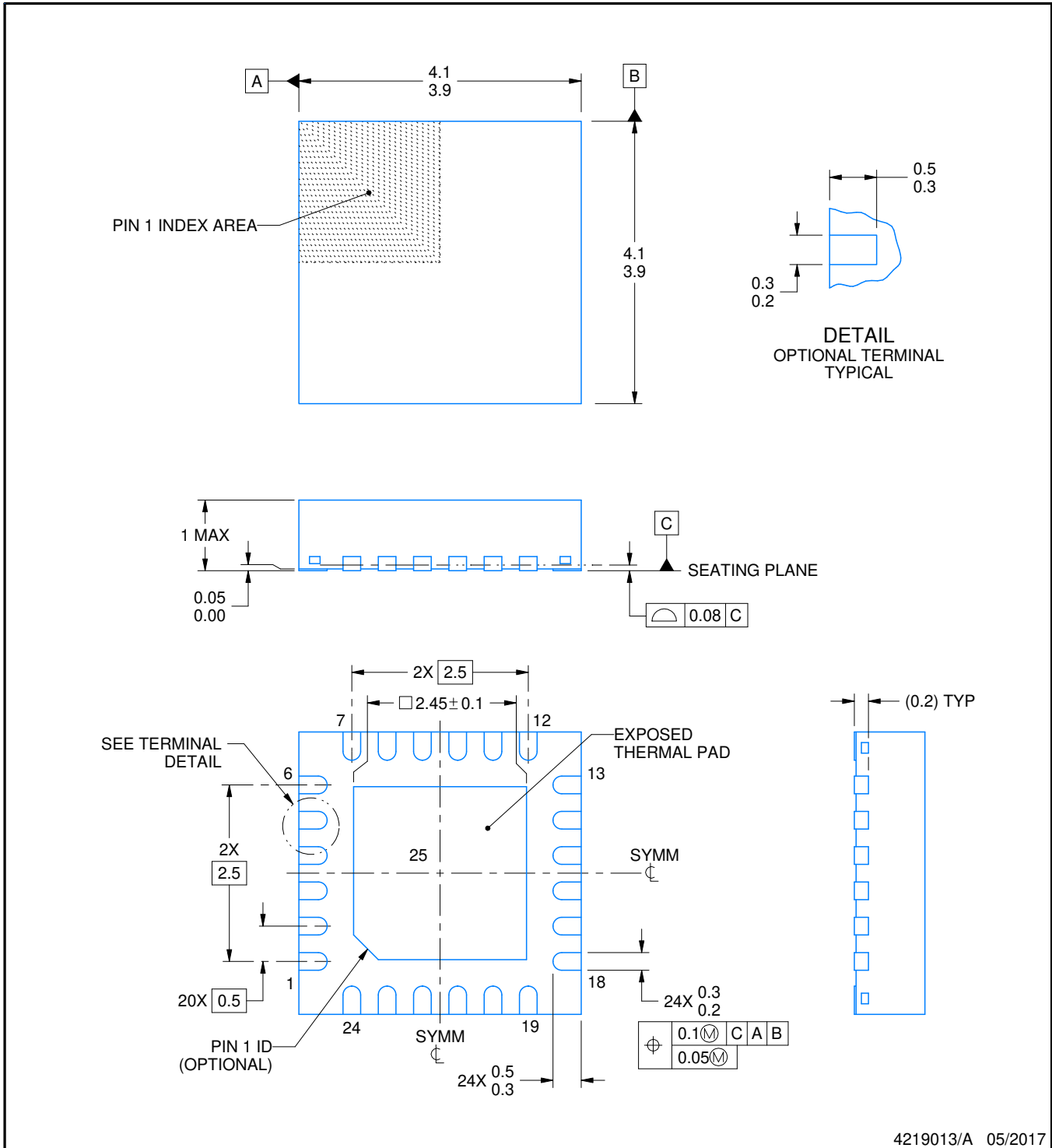

NOTES:

1. All linear dimensions are in millimeters. Any dimensions in parenthesis are for reference only. Dimensioning and tolerancing per ASME Y14.5M.
2. This drawing is subject to change without notice.
3. The package thermal pad must be soldered to the printed circuit board for thermal and mechanical performance.

EXAMPLE STENCIL DESIGN

RGE0024B

VQFN - 1 mm max height

PLASTIC QUAD FLATPACK - NO LEAD

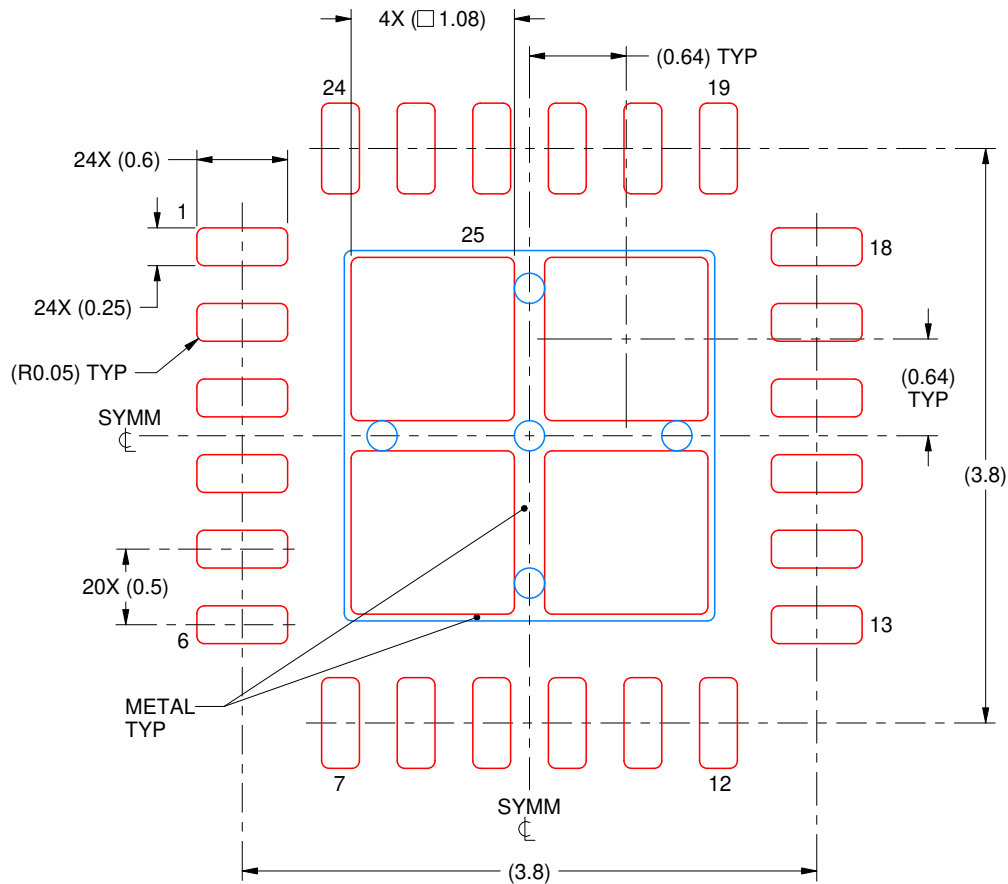

SOLDER PASTE EXAMPLE
BASED ON 0.125 mm THICK STENCIL

EXPOSED PAD 25
78% PRINTED SOLDER COVERAGE BY AREA UNDER PACKAGE
SCALE:20X

4219013/A 05/2017

NOTES: (continued)

6. Laser cutting apertures with trapezoidal walls and rounded corners may offer better paste release. IPC-7525 may have alternate design recommendations.

IMPORTANT NOTICE AND DISCLAIMER

TI PROVIDES TECHNICAL AND RELIABILITY DATA (INCLUDING DATASHEETS), DESIGN RESOURCES (INCLUDING REFERENCE DESIGNS), APPLICATION OR OTHER DESIGN ADVICE, WEB TOOLS, SAFETY INFORMATION, AND OTHER RESOURCES "AS IS" AND WITH ALL FAULTS, AND DISCLAIMS ALL WARRANTIES, EXPRESS AND IMPLIED, INCLUDING WITHOUT LIMITATION ANY IMPLIED WARRANTIES OF MERCHANTABILITY, FITNESS FOR A PARTICULAR PURPOSE OR NON-INFRINGEMENT OF THIRD PARTY INTELLECTUAL PROPERTY RIGHTS.

These resources are intended for skilled developers designing with TI products. You are solely responsible for (1) selecting the appropriate TI products for your application, (2) designing, validating and testing your application, and (3) ensuring your application meets applicable standards, and any other safety, security, or other requirements. These resources are subject to change without notice. TI grants you permission to use these resources only for development of an application that uses the TI products described in the resource. Other reproduction and display of these resources is prohibited. No license is granted to any other TI intellectual property right or to any third party intellectual property right. TI disclaims responsibility for, and you will fully indemnify TI and its representatives against, any claims, damages, costs, losses, and liabilities arising out of your use of these resources.

TI's products are provided subject to TI's Terms of Sale (www.ti.com/legal/termsofsale.html) or other applicable terms available either on ti.com or provided in conjunction with such TI products. TI's provision of these resources does not expand or otherwise alter TI's applicable warranties or warranty disclaimers for TI products.

Mailing Address: Texas Instruments, Post Office Box 655303, Dallas, Texas 75265
Copyright © 2020, Texas Instruments Incorporated