

The Design Difference... Unsurpassed Panel Management System[®]

AttaBox's innovative "Freedom" Panel Management System[®] enables Freedom users to take maximum advantage of ALL enclosure space...including the inside of the cover!

- Back Panel
- Variable Height Stationary Panel
- Variable Height Swing Panel
- Dead Front Swing Panel
- Cover Panel



The Freedom Panel Management System[®] Offers Many Benefits:

- Full utilization of both space and design. All space within the enclosure can be accessed and utilized with minimal requirements for additional mounting hardware.
- Panel maneuverability at both the time of assembly and in actual field use.
- Optimized use and function of all usable space within the enclosure while assisting in the mounting of cover mounted devices, such as touchpads and printed circuit boards.
- Maximized visibility of panels that offer critical feedback, such as instrumentation, while preserving the integrity of the enclosure.
- Ability to meet unique visual requirements usually associated with a dead front panel.
- Ability to meet the needs for mounting surface at rear of enclosure.
- Ability to meet end users' design capabilities and field changes that would otherwise require major modification or costly disassembly.
- Ability to externally assemble, then "drop in" to the enclosure DIN rail mounted components, thereby minimizing assembly, modification and field servicing.
- Maximum surface area for pushbutton or touchpad layout. Maximizes end users' design possibilities.
- Ability to meet end users' requirements for the installation of isolated visibility or custom visual requirements.
- Offers restricted access to areas of adjustment and calibration.

Freedom | Panel Management System

BACK PANEL



- Traditional sized back panel
- Common industry mounting footprint
- Wide choice of material

DEAD FRONT SWING PANEL



- Mounts at the front of the enclosure
- Larger surface area when compared to the variable height swing panel
- Hinged on one side, secured to the other
- Used in conjunction with corner mounting posts

VARIABLE HEIGHT STATIONARY PANEL



- Mounts at any height in the enclosure base including as back panel or use as a top stationary dead front panel
- Larger panel area than traditional back panels maximizes surface mounting area
- Used in conjunction with corner mounting posts

VARIABLE HEIGHT SWING PANEL



- Mounts at any height in the enclosure base
- Hinged on one side, secured to the other
- Used in conjunction with corner mounting posts

COVER PANEL



- Stationary panel that mounts to the inside of the enclosure cover.

USE MULTIPLE PANELS



Freedom | Panel Management System

Unique. Reliable. Flexible. Revolutionary. It's What You Want It To Be!

Just imagine ... an enclosure system that truly can be what you want...and need...it to be!
Today, that enclosure system is a reality...with **Freedom**, from AttaBox.

The revolutionary design of **Freedom** provides a one-of-a-kind enclosure architecture that can range from "bare bones" basic yet durable simplicity to a highly customized, sophisticated protective structure.

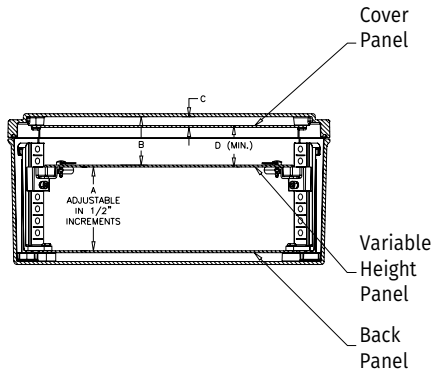

FREEDOM SERIES ENCLOSURES PANEL MANAGEMENT SYSTEM®

SIZE ID	FIXED PANEL (MIN) A	SWING PANEL (MIN) A	(MAX) A	OPAQUE/BONDED WINDOW CVR B	CLEAR CVR B	C	D (MIN)
60604	1.50 (38.1)	2.00 (50.08)	2.50 (63.50)	1.025 (26.03)	1.025 (26.03)	.375 (9.52)	.57 (14.48)
80604	1.50 (38.1)	2.00 (50.08)	2.50 (63.50)	1.025 (26.03)	1.025 (26.03)	.375 (9.52)	.57 (14.48)
80804	1.50 (38.1)	2.00 (50.08)	2.50 (63.50)	1.025 (26.03)	1.025 (26.03)	.375 (9.52)	.57 (14.48)
100806	1.50 (38.1)	2.00 (50.08)	4.50 (114.30)	1.025 (26.03)	1.025 (26.03)	.375 (9.52)	.57 (14.48)
121006	1.50 (38.1)	2.00 (50.08)	4.50 (114.30)	1.025 (26.03)	0.994 (25.24)	.375 (9.52)	.57 (14.48)
141206	1.50 (38.1)	2.00 (50.08)	4.50 (114.30)	1.025 (26.03)	0.963 (24.44)	.375 (9.52)	.57 (14.48)
141208	1.50 (38.1)	2.00 (50.08)	6.50 (165.1)	1.025 (26.03)	0.963 (24.44)	.375 (9.52)	.57 (14.48)
161408	1.50 (38.1)	2.00 (50.08)	6.50 (165.1)	1.025 (26.03)	0.963 (24.44)	.375 (9.52)	.57 (14.48)
181610	1.50 (38.1)	2.00 (50.08)	8.50 (215.90)	1.025 (26.03)	N/A	.375 (9.52)	.57 (14.48)
201610	1.50 (38.1)	2.00 (50.08)	8.50 (215.90)	1.025 (26.03)	N/A	.375 (9.52)	.57 (14.48)

Note: Swing and stationary panels adjust in 1/2" increments
"C" not applicable for clear cover
Cover panel kit not available for clear cover options

VARIABLE HEIGHT SWING PANEL

PART NUMBER	A	B	PANEL THK.	PANEL TYPE
P806ASA	6.38 (162)	6.56 (1167)	.080 (2)	Flat
P808ASA	6.38 (162)	8.56 (217)	.080 (2)	Flat
P1008ASA	8.38 (213)	8.56 (217)	.080 (2)	Flat
P1210ASA	10.38 (264)	10.56 (268)	.080 (2)	Flat
P1412ASA	12.38 (314)	12.56 (319)	.080 (2)	Flat
P1614ASA	14.38 (365)	14.56 (370)	.080 (2)	Flat
P1816ASA	16.38 (416)	16.56 (421)	.080 (2)	Flat
P2016ASA	18.38 (467)	16.56 (421)	.080 (2)	Flat

Caution: Metric units are for reference; do not convert.

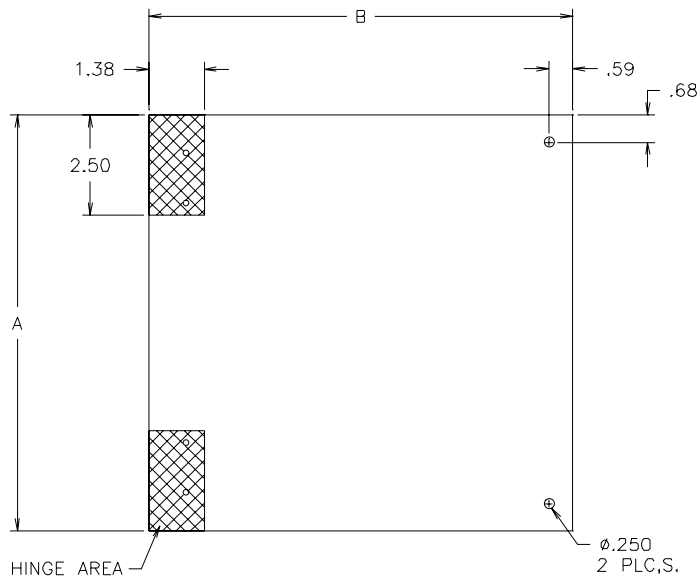

COVER PANEL DIMENSIONS

PART NUMBER	A	B	C	D	PANEL THK.	PANEL TYPE	HOLE DIA	#OF HOLES
CP606AL	5.64 (143)	5.64 (143)	5.02 (127)	5.02 (127)	.080 (2)	Flat	.25 (6)	4
CP806AL	7.68 (195)	5.64 (143)	7.05 (179)	5.02 (127)	.080 (2)	Flat	.25 (6)	4
CP808AL	7.68 (195)	7.68 (195)	7.05 (179)	7.05 (179)	.080 (2)	Flat	.25 (6)	4
CP1008AL	9.71 (247)	7.71 (196)	9.08 (231)	7.08 (180)	.080 (2)	Flat	.25 (6)	4
CP1210AL	11.74 (298)	9.74 (247)	11.12 (282)	9.12 (232)	.080 (2)	Flat	.25 (6)	4
CP1412AL	13.78 (350)	11.78 (299)	13.15 (334)	11.15 (283)	.080 (2)	Flat	.25 (6)	4
CP1614AL	15.81 (402)	13.81 (351)	15.18 (386)	13.18 (334)	.080 (2)	Flat	.25 (6)	4
CP1816AL	17.94 (456)	15.94 (405)	17.31 (440)	15.31 (389)	.080 (2)	Flat	.25 (6)	4
CP2016AL	19.76 (502)	15.76 (400)	19.13 (486)	15.13 (384)	.080 (2)	Flat	.25 (6)	4

Caution: Metric units are for reference; do not convert.

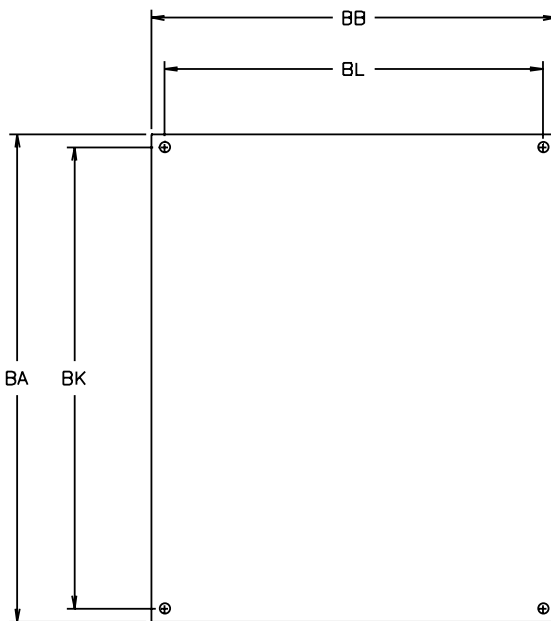
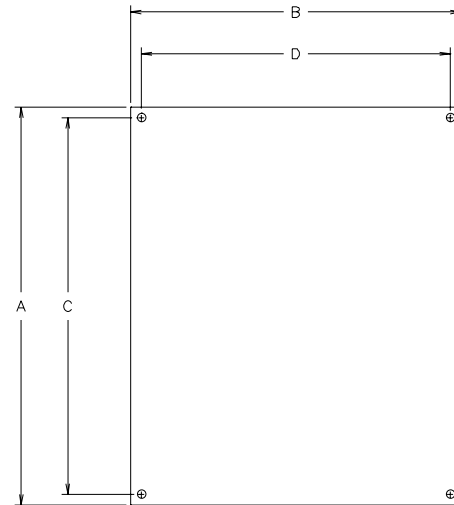

BACK PANEL DIMENSIONS

PART NUMBER	BA	BB	BK	BL	PANEL THK.	PANEL TYPE	HOLE DIA.	#OF HOLES
BP66	4.88 (124)	4.88 (124)	4.25 (108)	4.25 (108)	.080 (2)	Flat	.25 (6)	4
BP86	6.88 (175)	4.88 (124)	6.25 (159)	4.25 (108)	.080 (2)	Flat	.25 (6)	4
BP88	6.88 (175)	6.88 (175)	6.25 (159)	6.25 (159)	.080 (2)	Flat	.25 (6)	4
BP108	8.88 (225)	6.88 (175)	8.25 (210)	6.25 (159)	.080 (2)	Flat	.25 (6)	4
BP1210	10.88 (276)	8.88 (225)	10.25 (260)	8.25 (210)	.080 (2)	Flat	.25 (6)	4
BP1412	12.88 (327)	10.88 (276)	12.25 (311)	10.25 (260)	.080 (2)	Flat	.25 (6)	4
BP1614	14.88 (378)	12.88 (327)	14.25 (362)	12.25 (311)	.080 (2)	Flat	.25 (6)	4
BP1816	16.88 (429)	14.88 (378)	16.25 (413)	14.25 (362)	.080 (2)	Flat	.25 (6)	4
BP2016	18.88 (480)	14.88 (378)	18.25 (464)	14.25 (362)	.090 (2)	Flat	.25 (6)	4

Caution: Metric units are for reference; do not convert.

Suffix - Available materials

AL - Aluminum

CS - Painted Carbon Steel

Example: BP1210A

DEAD FRONT SWING PANEL DIMENSIONS

PART NUMBER	A	B	C	D	PANEL THK.	PANEL TYPE
P806SWA	8.56 (217)	6.56 (167)	5.70 (145)	6.37 (162)	.080 (2)	Flat
P808SWA	8.56 (217)	8.56 (217)	7.70 (196)	6.37 (162)	.080 (2)	Flat
P1008SWA	10.56 (268)	8.56 (217)	7.70 (196)	8.37 (213)	.080 (2)	Flat
P1210SWA	12.56 (319)	10.56 (268)	10.37 (246)	9.70 (263)	.080 (2)	Flat
P1412SWA	14.56 (370)	12.56 (319)	11.70 (297)	12.37 (314)	.080 (2)	Flat
P1614SWA	16.56 (421)	14.56 (370)	15.57 (399)	14.37 (365)	.080 (2)	Flat
P1816SWA	18.56 (471)	16.56 (421)	15.70 (399)	16.37 (467)	.080 (2)	Flat
P2016SWA	20.56 (522)	16.56 (421)	15.70 (399)	18.37 (467)	.080 (2)	Flat

Caution: Metric units are for reference; do not convert.

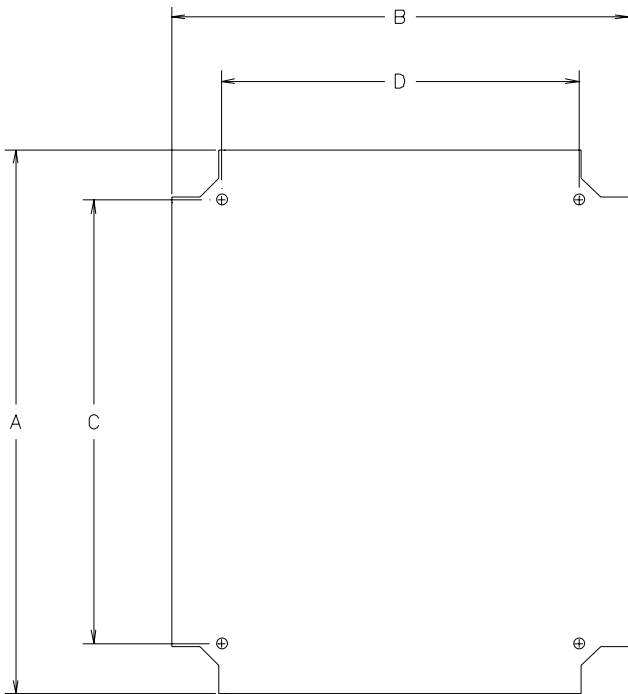
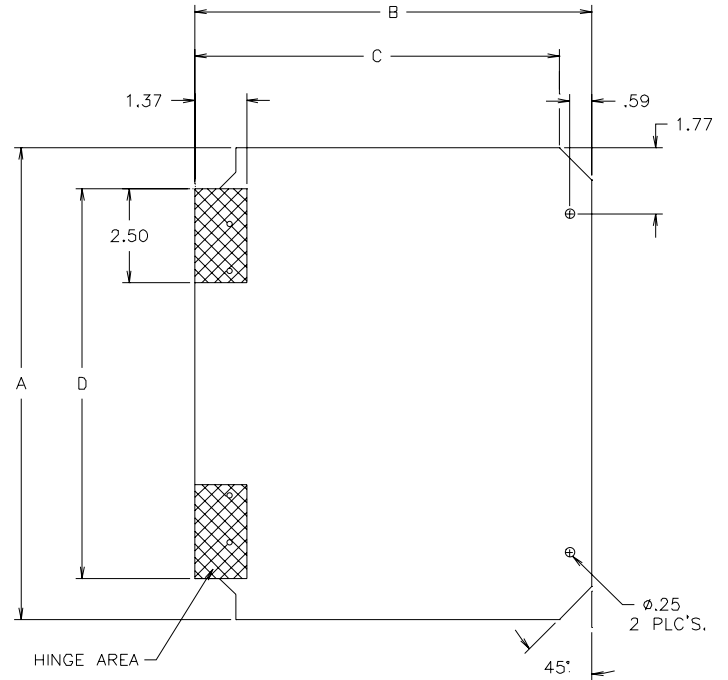

VARIABLE HEIGHT STATIONARY PANEL DIMENSIONS

PART NUMBER	A	B	C	D	PANEL THK.	PANEL TYPE	HOLE DIA.	#OF HOLES
P606STA	6.56 (167)	6.56 (167)	4.25 (108)	4.25 (108)	.080 (2)	Flat	.25 (6)	4
P806STA	8.56 (217)	6.56 (167)	6.25 (159)	4.25 (108)	.080 (2)	Flat	.25 (6)	4
P808STA	8.56 (217)	8.56 (217)	6.25 (159)	6.25 (159)	.080 (2)	Flat	.25 (6)	4
P1008STA	10.56 (268)	8.56 (217)	8.25 (210)	6.25 (159)	.080 (2)	Flat	.25 (6)	4
P1210STA	12.56 (319)	10.56 (268)	10.25 (210)	8.25 (260)	.080 (2)	Flat	.25 (6)	4
P1412STA	14.56 (370)	12.56 (319)	12.25 (311)	10.25 (260)	.080 (2)	Flat	.25 (6)	4
P1614STA	16.56 (421)	14.56 (370)	14.25 (362)	12.25 (311)	.080 (2)	Flat	.25 (6)	4
P1816STA	18.56 (471)	16.56 (421)	16.25 (413)	14.25 (362)	.080 (2)	Flat	.25 (6)	4
P2016STA	20.56 (522)	16.56 (421)	18.25 (464)	14.25 (362)	.080 (2)	Flat	.25 (6)	4

Caution: Metric units are for reference; do not convert.

Freedom | Panel Management System

PANEL KITS - ACCESSORIES ONLY, PANELS NOT INCLUDED

SIZE ID	STATIONARY PANEL ACCESSORY KIT	STATIONARY PANEL BRACKET KIT	SWING PANEL ACCESSORY KIT	SWING PANEL BRACKET KIT	CORNER POST KIT
60604	FR4PKA	FRAPBKT	N/A	N/A	FR4POST
80604	FR4PKA	FRAPBKT	FR4SPKA	FRSPBKT	FR4POST
80804	FR4PKA	FRAPBKT	FR4SPKA	FRSPBKT	FR4POST
100806	FR6PKA	FRAPBKT	FR6SPKA	FRSPBKT	FR6POST
121006	FR6PKA	FRAPBKT	FR6SPKA	FRSPBKT	FR6POST
141206	FR6PKA	FRAPBKT	FR6SPKA	FRSPBKT	FR6POST
141208	FR8PKA	FRAPBKT	FR8SPKA	FRSPBKT	FR8POST
161408	FR8PKA	FRAPBKT	FR8SPKA	FRSPBKT	FR8POST
181610	FR10PKA	FRAPBKT	FR10SPKA	FRSPBKT	FR10POST
201610	FR10PKA	FRAPBKT	FR10SPKA	FRSPBKT	FR10POST



Stationary Panel Bracket Kit



Swing Panel Accessory Kit



Swing Panel Bracket Kit



Corner Post Kit



Stationary Panel Accessory Kit



Dead Front Swing Panel & Swing Panel Accessory Kit

PANEL & ACCESSORY COMBINATION KITS, INCLUDES PANEL

SIZE ID	DEAD FRONT SWING PANEL & ACCESS. KIT	VARIABLE HEIGHT SWING PANEL & ACCESS. KIT	VARIABLE HEIGHT STATIONARY PNL & ACCESS. KIT	VARIABLE HEIGHT BACK PNL & ACCESS. KIT
60604	N/A	N/A	FR60604PKA	FR60604BPKA
80604	FR80604SPK	FR80604SPKA	FR80604PKA	FR80604BPKA
80804	FR80804SPK	FR80804SPKA	FR80804PKA	FR80804BPKA
100806	FR100806SPK	FR100806SPKA	FR100806PKA	FR100806BPKA
121006	FR121006SPK	FR121006SPKA	FR121006PKA	FR121006BPKA
141206	FR141206SPK	FR141206SPKA	FR141206PKA	FR141206BPKA
141208	FR141208SPK	FR141208SPKA	FR141208PKA	FR141208BPKA
161408	FR161408SPK	FR161408SPKA	FR161408PKA	FR161408BPKA
181610	FR181610SPK	FR181610SPKA	FR181610PKA	FR181610BPKA
201610	FR201610SPK	FR201610SPKA	FR201610PKA	FR201610BPKA



Variable Height Swing Panel & Swing Panel Accessory Kit



Variable Height Back Panel & Stationary Panel Accessory Kit



Variable Height Stationary Panel & Stationary Panel Accessory Kit

Freedom | Panel Management System



Mounting Feet



Cover Screw Kit



Hinge Kit

OTHER ACCESSORY KITS

SIZE ID	MTG. FOOT KIT	OPAQUE COVER SCREW KIT	PULL LATCH KIT	HINGE KIT
60604	FRMGFTKIT	FRWKIT	FRHPLKIT	FR3HINGEKIT
80604	FRMGFTKIT	FRWKIT	FRHPLKIT	FR4HINGEKIT
80804	FRMGFTKIT	FRWKIT	FRHPLKIT	FR4HINGEKIT
100806	FRMGFTKIT	FRWKIT	FRHPLKIT	FR5HINGEKIT
121006	FRMGFTKIT	FRWKIT	FRHPLKIT	FR5HINGEKIT
141206	FRMGFTKIT	FRWKIT	FRHPLKIT	FR6HINGEKIT
141208	FRMGFTKIT	FRWKIT	FRHPLKIT	FR6HINGEKIT
161408	FRMGFTKIT	FRWKIT	FRHPLKIT	FR6HINGEKIT
181610	FRMGFTKIT	FRWKIT	FRHPLKIT	FR6HINGEKIT
201610	FRMGFTKIT	FRWKIT	FRHPLKIT	FR6HINGEKIT



Lockable Pull Latch Kit

Freedom | Covers Only

OPAQUE COVERS

VIEWING WINDOW COVERS

PART NUMBER	PART NUMBER
FR606CVR	FRW606CVR
FR806CVR	FRW806CVR
FR808CVR	FRW808CVR
FR1008CVR	FRW1008CVR
FR1210CVR	FRW1210CVR
FR1412CVR	FRW1412CVR
FR1614CVR	FRW1614CVR
FR1816CVR	FRW1816CVR
FR2016CVR	FRW2016CVR