

- ◆ Rugged metal case for harsh industrial environments
- ◆ Industrial operating temperature range:  $-25^{\circ}\text{C}$  to  $+70^{\circ}\text{C}$
- ◆ Overload and overtemperature protection
- ◆ Power boost up to 120 %
- ◆ Power-Good signal
- ◆ Shock and vibration proof
- ◆ International safety approval package
- ◆ ATEX certification for hazardous locations
- ◆ Decoupling module for redundant operation (optional)
- ◆ Wall mounting (opt.)
- ◆ 3-year product warranty



The TSPC series are high performance DIN-rail mount power supplies for harsh industrial environments. The design is based on the popular TRACOPOWER TSP series but with reduced electrical features to make these power supplies an easy to install and cost efficient but reliable solution for basic applications.

Excellent electrical specifications and high immunity against electrical disturbances makes these compact modules the best choice for reliable industrial systems and machines.

For system applications all models provide a Power-Good signal.

The TSPC series power supplies complies with the latest safety and EMC standards for industrial environments and include ATEX EN 60079 certification for applications in hazardous locations.

### Models

Order code	Output power nominal	Output voltage nominal	Output current nominal
TSPC 050-112	50 W	12 VDC	4.0 A
TSPC 050-124HL*	50 W	24 VDC	2.1 A
TSPC 050-124	50 W	24 VDC	2.1 A
TSPC 080-112	80 W	12 VDC	6.6 A
TSPC 080-124	80 W	24 VDC	3.3 A
TSPC 120-124	120 W	24 VDC	5.0 A
TSPC 120-148	120 W	48 VDC	2.5 A
TSPC 240-124	240 W	24 VDC	10 A
TSPC 240-148	240 W	48 VDC	5.0 A
TSPC 480-124	480 W	24 VDC	20 A
TSPC 480-148	480 W	48 VDC	10 A

\*Additionally complies with UL hazloc

### Input Specifications

Input voltage	– nominal ranges	TSPC 050	100 – 240 VAC universal input
		other models	100 – 120 / 220 – 240 VAC by selection switch
	– effective ranges	TSPC 050	85 – 264 VAC universal input
		other models	85 – 132 / 187 – 264 VAC by selection switch
	– output power derating at input <100 VAC		3.3 %/V
Input voltage frequency			47 – 63 Hz
Harmonic limits			EN 61000-3-2
Holdup time			10 ms min.
Inrush current			40 A
Recommended circuit breaker, characteristic C or fuse, slow blow type		– TSPC 080/120	6.0 – 16.0 A
		– TSPC 240	10.0 – 16.0 A
		– TSPC 480	16.0 – 25.0 A
Efficiency			85 – 93 %

### Output Specifications

Output voltage adj. range		12 VDC models:	12 – 14 VDC
			output power derating above 12 VDC : 10 %/V
		24 VDC models:	24 – 28 VDC
			output power derating above 24 VDC : 5 %/V
		48 VDC models:	48 – 56 VDC
			output power derating above 48 VDC : 2.5 %/V
Boost output current			120 % (at 24 VDC output voltage)
			continuous at <+50°C ambient temperature
	– power derating above 50°C ambient		2 %/°C
	– power derating at input <115 VAC		1.3 %/V
	– power derating at input <220 VAC		0.6 %/V (at upper input voltage range)
Regulation	– Input variation		1 % max.
	– Load variation (0–100 %)		1 % max.
Ripple and Noise (20MHz bandwidth)			100 mVp-p typ. (200 mVp-p max.)
Overload protection			130 % min. (of I <sub>out</sub> nom., constant current)
Short circuit current			90 % of I <sub>out</sub> nom. (typ.), foldback
Output overvoltage protection		12 VDC models:	25 V max.
		24 VDC models:	40 V max. (TSPC 120, TSPC 240, TSPC 480)
			45 V max. (TSPC 050, TSPC 080)
		48 VDC models:	60 V max.
Overtemperature protection			switch off at overtemperature, automatic restart
Power back immunity		12 VDC models:	16 V (18 V for 1 s)
		24 VDC models:	35 V (40 V for 1 s)
		48 VDC models:	63 V (65 V for 1 s)
Power OK signal	– trigger threshold	12 VDC models:	10.0 – 11.5 V
		24 VDC models:	21.0 – 22.5 V
		48 VDC models:	42.0 – 45.0 V
	– output signal	12 VDC models:	open collector 20 mA max.
		24 VDC models:	open collector 10 mA max.
		48 VDC models:	open collector 5 mA max.
			Active high: Connected to V <sub>out</sub> in normal operation, high resistance at failure
Max. capacitive load			unlimited

### General Specifications

Temperature range	– Operating		–25°C to +70°C max. (with derating)
	– Output current derating		2.5 %/°C above 60°C
	– Storage		–40°C to +85°C
Cooling			convection cooling, no internal fan
Humidity (non condensing)			95 % rel. H max.

**General Specifications**

Pollution degree		2
Altitude during operation		2'000 m max.
Temperature coefficient		0.02 %/K
Reliability, calculated MTBF at +25°C acc. to IEC 61709	– TSPC 080 – TSPC 120 – TSPC 240 – TSPC 480	2.4 Mio. h 2.5 Mio. h 1.7 Mio. h 1.4 Mio. h
Isolation		according to IEC/EN 60950-1, UL 60950-1, UL 508
Safety standards	– Information technology equipment – Measurement, Control & Laboratory – Industrial control equipment – Electrical equipment for machines – Electronic equipment for power installation – Safety of transformers – Control equipment for hazardous location – ATEX (for IP 54 enclosure) – UL hazloc (TSPC 050-124HL only) – Certification documents	IEC/EN 60950-1, UL 60950-1, CSA 22.2 No 60950-1-07 IEC/EN 61010-1, IEC/EN 61010-2-201 UL 508, CSA-C22.2 No.107 EN 60204-1 EN 50178 EN 61558-2-6, EN 61558-2-16 EN 60079-15 II3G EX nA IIC T4 certificate no. EPS 10 ATEX 1 269 X UL 121201 Class I; Div 2; Groups A,B,C & D; T4 <a href="http://www.tracopower.com/overview/tspc">www.tracopower.com/overview/tspc</a>
Class of protection		safety class I (IEC 536)
Degree of protection		IP 20 (IEC/EN 60529)
Electromagnetic compatibility (EMC), Emissions	– Conducted RI suppression on input – Radiated RI suppression	EN 61000-6-3, EN 61204-3 EN 55011 class B, EN 55022 class B, EN 55011 class B, EN 55022 class B,
Electromagnetic compatibility (EMC), Immunity	– Electrostatic discharge (ESD) – Radiated RF field immunity – Electrical fast transient / burst immunity – Surge immunity – Immunity to conducted RF disturbances – Power frequency field immunity – Mains voltage dips and interruptions	EN 61000-6-2, EN 61204-3 IEC/EN 61000-4-2 4 kV / 8 kV criteria B IEC/EN 61000-4-3 10 V / m criteria A IEC/EN 61000-4-4 2 kV criteria B IEC/EN 61000-4-5 1 kV / 2 kV criteria B IEC/EN 61000-4-6 10 V criteria A IEC/EN 61000-4-8 30 A / m criteria A IEC/EN 61000-4-11 criteria B/C
Environment	– Vibration acc. IEC 68-2-6; – Shock acc. IEC 60068-2-27	3 axis, sine sweep, 10 – 55 Hz, 1 g, 1 oct/min 3 axis, 15 g half sine, 11 ms
Enclosure material		aluminium (chassis) / stainless steel (cover)
Mounting	– DIN-rail mounting  – Wall mounting (option)	for DIN-rails as per EN 50022-35x15/7.5 (snap-on with self-locking spring) with wall mounting bracket - see page 12
Environmental compliance	– Reach – RoHS	<a href="http://www.tracopower.com/info/reach-declaration.pdf">www.tracopower.com/info/reach-declaration.pdf</a> RoHS directive 2011/65/EU
Connection	– Input / Output – Power Good signal (mating connector)	screw terminals Phoenix contact MC 1,5/2-ST-3,5 (not included)
Installation instructions		<a href="http://www.tracopower.com/overview/tspc">www.tracopower.com/overview/tspc</a>

**Accessories (optional)**



Decoupling module for redundant operation see:  
[www.tracopower.com/products/tspc-dcm.pdf](http://www.tracopower.com/products/tspc-dcm.pdf)



Wall mounting brackets: see last page

**Outline Dimensions**

TSPC 050-112  
TSPC 050-124(HL\*)

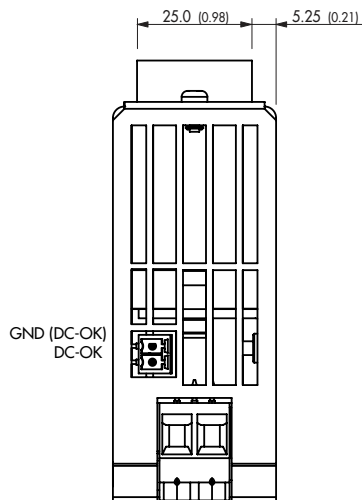
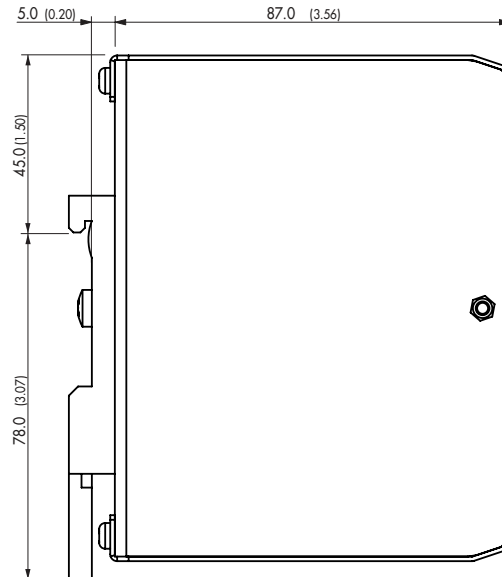
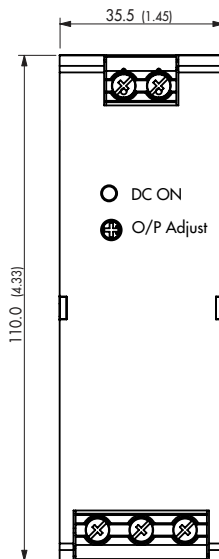
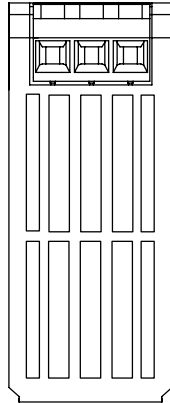

\*TSPC 050-124HL contains mating plug on DC-OK connector fitted with cable tie which enlarges height of product 9mm max.

All specifications valid at nominal input voltage, full load and +25°C after warm-up time unless otherwise stated.

**Outline Dimensions**

TSPC 080-112  
TSPC 080-124

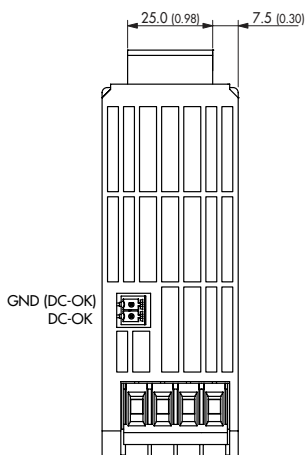
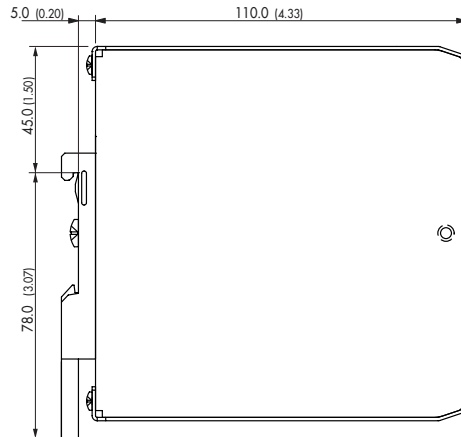
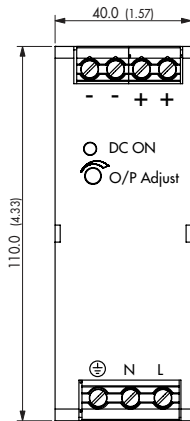
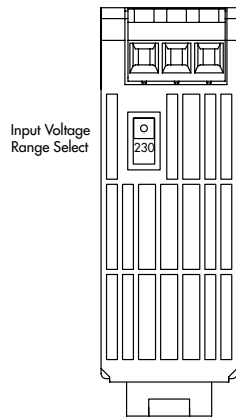

**Weight:** 400 g (14.1 oz)

Dimensions in [mm], ( ) = Inch

Tolerances:  $\pm 0.5$  mm ( $\pm 0.02$ )

**Outline Dimensions**

TSPC 120-124  
TSPC 120-148

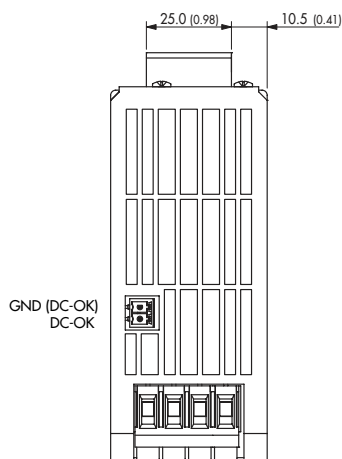
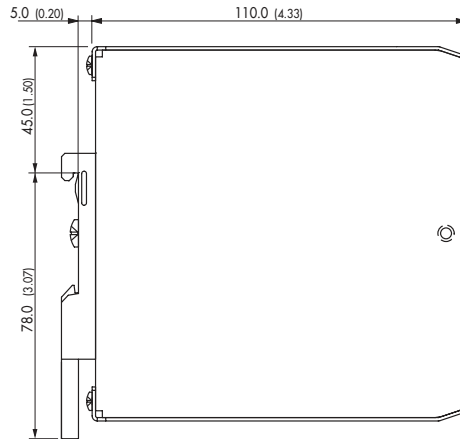
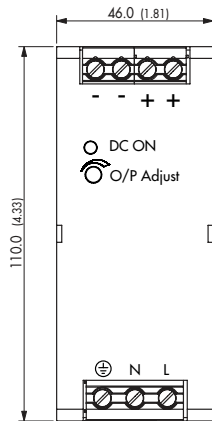
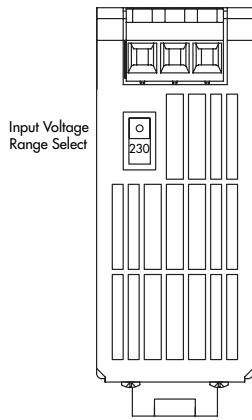

**Weight:** 500 g (17.7 oz)

Dimensions in [mm], ( ) = Inch

Tolerances:  $\pm 0.5$  mm ( $\pm 0.02$ )

**Outline Dimensions**

TSPC 240-124  
TSPC 240-148

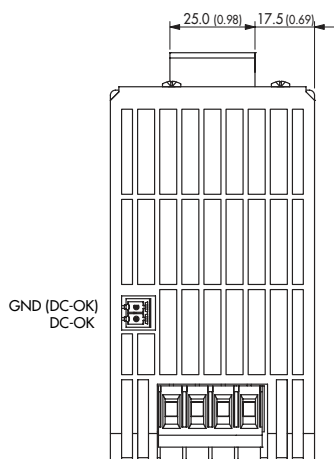
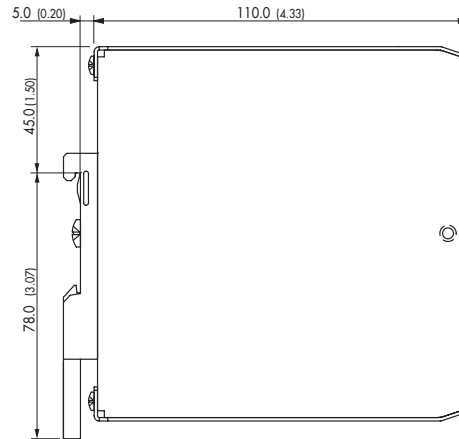
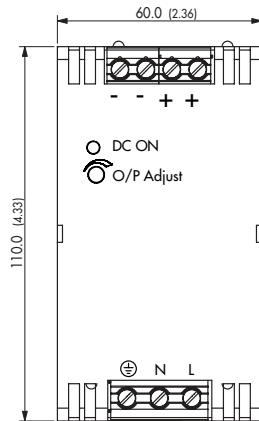
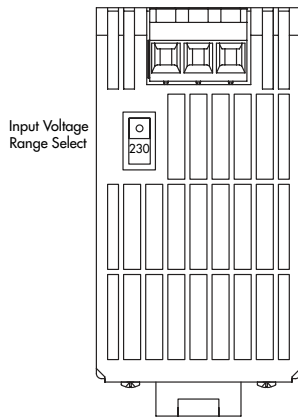

**Weight: 750 g (26.5 oz)**

Dimensions in [mm], ( ) = Inch

Tolerances:  $\pm 0.5$  mm ( $\pm 0.02$ )

**Outline Dimensions**

TSPC 480-124  
TSPC 480-148

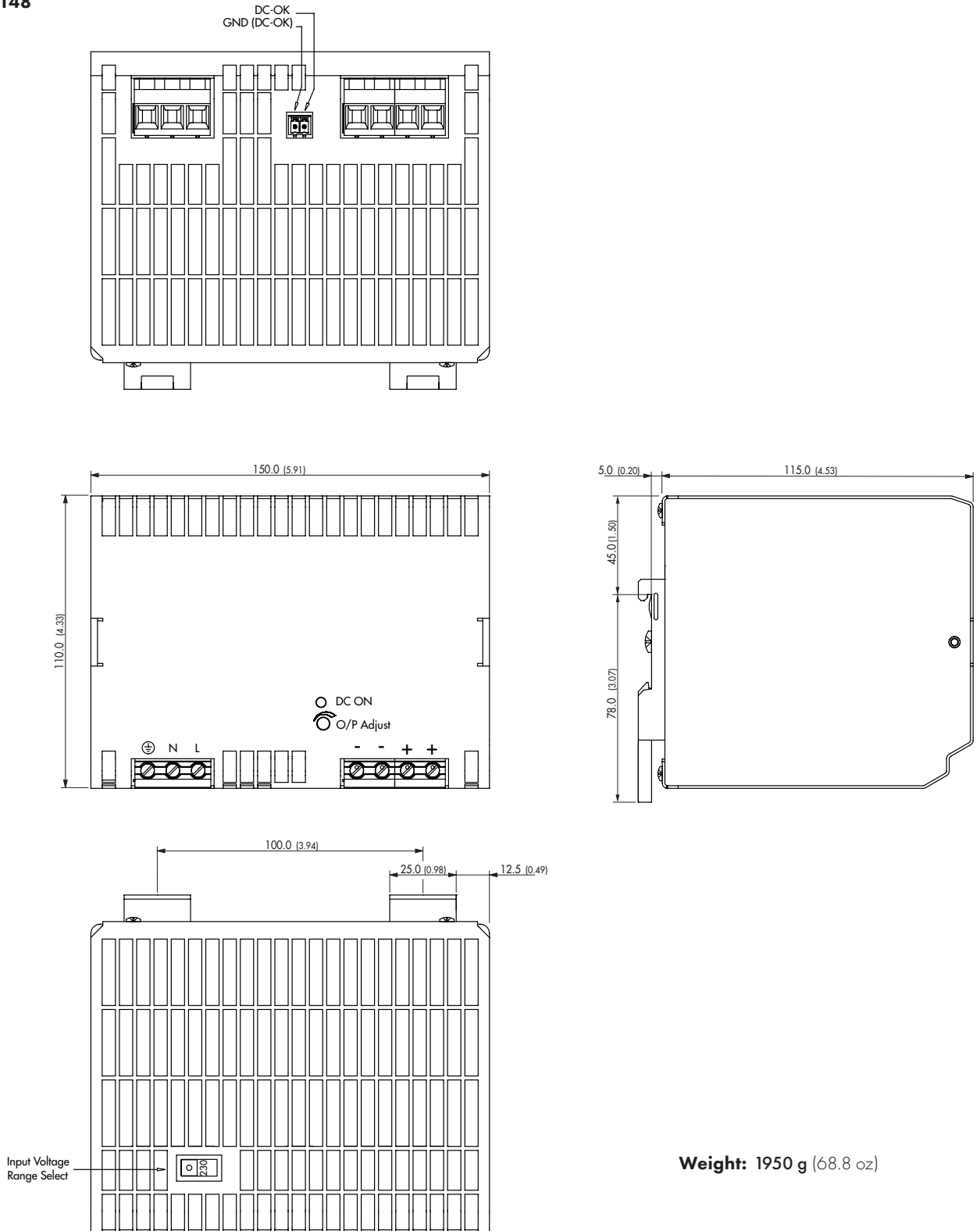

**Weight: 1950 g (68.8 oz)**

Dimensions in [mm], ( ) = Inch  
Tolerances:  $\pm 0.5$  mm ( $\pm 0.02$ )



**TSP-WMK Wall Mounting Bracket**

order code	for models	content of kit
TSP-WMK03	TSPC 080, TSPC 120, TSPC 240, TSP-DCM600	1 bracket
TSP-WMK02	TSPC 480	2 brackets

**TSP-WMK03**

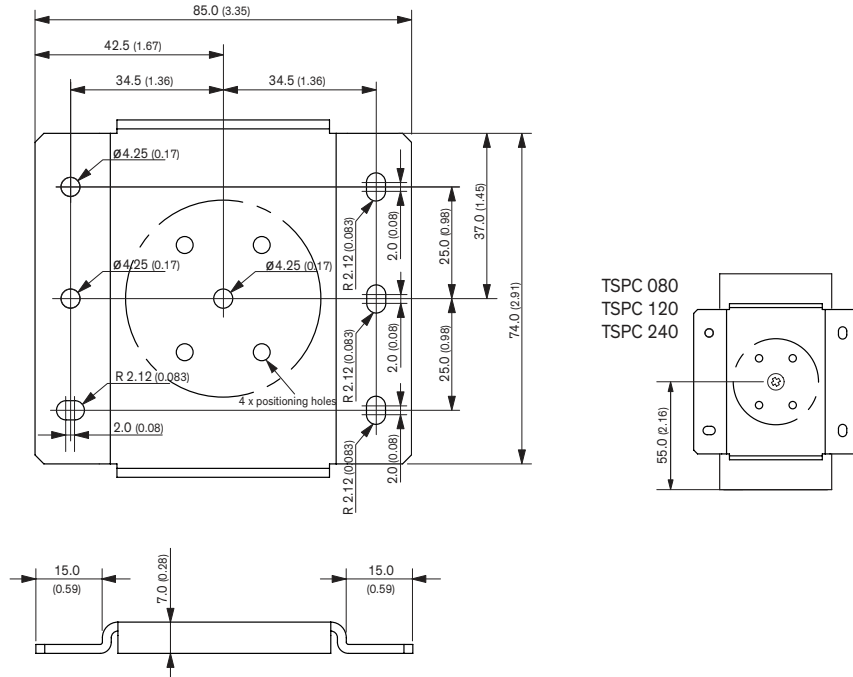

Material: 2 mm Mild Steel  
Tolerance:  $\pm 0.1\text{mm}$  ( $\pm 0.004$ )

**TSP-WMK02**

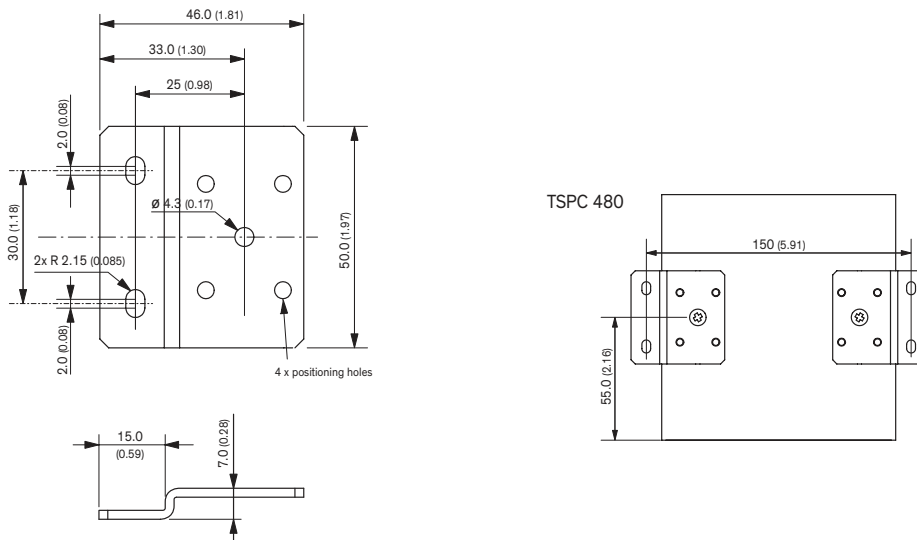

Material: 2 mm Mild Steel  
Tolerance:  $\pm 0.1\text{mm}$  ( $\pm 0.004$ )

Dimensions: [mm] ( ) = Inch

Dimensions in [mm], ( ) = Inch  
Tolerances:  $\pm 0.5\text{ mm}$  ( $\pm 0.02$ )

Specifications can be changed without notice! Make sure you are using the latest documentation, downloadable at [www.tracopower.com](http://www.tracopower.com)