

Overview

The PHE448 Series is a capacitor with polypropylene film dielectric and metal foil electrodes, encapsulated in self-extinguishing resin in a box of material meeting the requirements of UL 94 V-0.

Applications

Typical applications include high frequency and high voltage applications requiring capacitors with extremely high current handling capability, i.e., high dV/dt values.

ATTENTION -- This series was replaced by the R73 series. Please click on the link to the R73 series datasheet [HERE](#).

Benefits

- Rated voltage: 1,600 – 2,000 VDC
- Rated voltage: 650 – 700 VAC
- Capacitance range: 0.0001 – 0.022 μ F
- Lead spacing: 15 mm
- Capacitance tolerance: \pm 5%, other tolerances on request
- Climatic category: 55/105/56, IEC 60068-1
- Tape & Reel packaging in accordance with IEC 60286-2
- RoHS Compliant and lead-free terminations
- Category temperature range of -55°C to +105°C

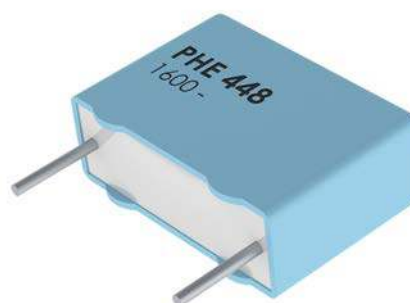

Customer Part Number

PHE448	R	B	4150	J	R06
Series	Rated Voltage (VDC)	Lead Spacing (mm)	Capacitance Code (pF)	Capacitance Tolerance	Packaging
Polypropylene Film/Foil	R = 1,600 S = 2,000	B = 15.0	The last three digits represent significant figures. The first digit specifies the total number of digits.	J = \pm 5% Other tolerances on request	See Ordering Options Table

KEMET Internal Part Number

F	448	B	D	152	J	1K6	C
Capacitor Class	Series	Lead Spacing (mm)	Size Code	Capacitance Code (pF)	Capacitance Tolerance	Rated Voltage (VDC)	Packaging
F = Film	Polypropylene Film/Foil	B = 15.0	See Dimension Table	First two digits represent significant figures. Third digit specifies number of zeros.	J = \pm 5%, Other tolerances on request	1K6 = 1,600 2K0 = 2,000	See Ordering Options Table

NOT FOR NEW DESIGN

Film Capacitors – General Purpose, Pulse and DC Transient Suppression

PHE448 Polypropylene Film/Foil, Radial

KEMET
a YAGEO company

Ordering Options Table

Lead Spacing Nominal (mm)	Type of Leads and Packaging	Lead Length (mm)	KEMET Lead and Packaging Code	Legacy Lead and Packaging Code
15	Standard Lead and Packaging Options			
	Bulk (Bag) – Short Leads	6 +0/-1	C	R06
	Bulk (Bag) – Long Leads	17 +0/-1	A	R17
	Other Lead and Packaging Options			
	Bulk (Bag) – Max Length Leads	30 +5/-0	ALW0L	R30
	Tape & Reel (Standard Reel)	$H_0 = 18.5 \pm 0.5$	L	R17T0
	Tape & Reel (Large Reel)	$H_0 = 18.5 \pm 0.5$	P	R17T1
Native 15 formed to 7.5	Ammo Pack	$H_0 = 16.5 \pm 0.5$	XLAF1	R25XA
	Tape & Reel (Standard Reel)	$H_0 = 16.5 \pm 0.5$	XLTF1	R25X2

Dimensions – Millimeters

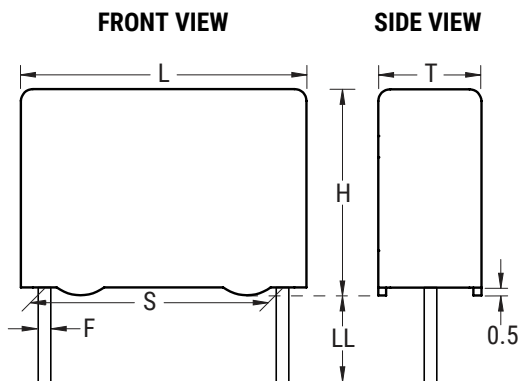

KEMET Size Code	Legacy Size Code	S		T		H		L		F	
		Nominal	Tolerance	Nominal	Tolerance	Nominal	Tolerance	Nominal	Tolerance	Nominal	Tolerance
BD	B04	15	±0.4	5.5	0/-0.5	10.5	0/-0.5	18	0/-0.5	0.8	±0.05
BL	B06	15	±0.4	7.5	0/-0.5	14.5	0/-0.5	18	0/-0.5	0.8	±0.05
BJ	B10	15	±0.4	6.5	0/-0.5	12.5	0/-0.5	18	0/-0.5	0.8	±0.05
BQ	B11	15	±0.4	8.5	0/-0.5	16	0/-0.5	18	0/-0.5	0.8	±0.05
BV	B14	15	±0.4	9.5	0/-0.5	17.5	0/-0.5	18	0/-0.5	0.8	±0.05
BY	B16	15	±0.4	11	0/-0.5	19	0/-0.5	18	0/-0.5	0.8	±0.05

Note: See Ordering Options Table for lead length (LL) options.

Performance Characteristics

Voltage Range (VDC)	1,600	2,000
Voltage Range (VAC)	650	700
Capacitance Range (μF)	0.0015 – 0.022	0.0001 – 0.0033
Capacitance Values	In accordance with IEC E12 series	
Capacitance Tolerance	$\pm 5\%$, other tolerances on request	
Category Temperature Range	-55°C to $+105^{\circ}\text{C}$	
Rated Temperature	$+85^{\circ}\text{C}$	
Voltage Derating	The rated voltage is decreased with $1.3\%/^{\circ}\text{C}$ between $+85^{\circ}\text{C}$ and $+105^{\circ}\text{C}$	
Climatic Category	IEC 60068-1, 55/105/56	
Dissipation Factor $\tan\delta$	Maximum Values at $+23^{\circ}\text{C}$	
	1 kHz	0.0003
	10 kHz	0.0005
	100 kHz	0.001
Insulation Resistance	Measured at $+23^{\circ}\text{C}$, 100 VDC 60 seconds for $V_R < 500$ VDC and at 500 VDC for $V_R \geq 500$ VDC	
	Minimum Values Between Terminals	
	$\geq 100,000$ M Ω	
	Minimum Values Between Terminals and Case	
	$\geq 100,000$ M Ω	

Derating of V_{rms} vs. Frequency, $+85^{\circ}\text{C}$ Ambient Temperature and 10°C Internal Heating, Typical Values

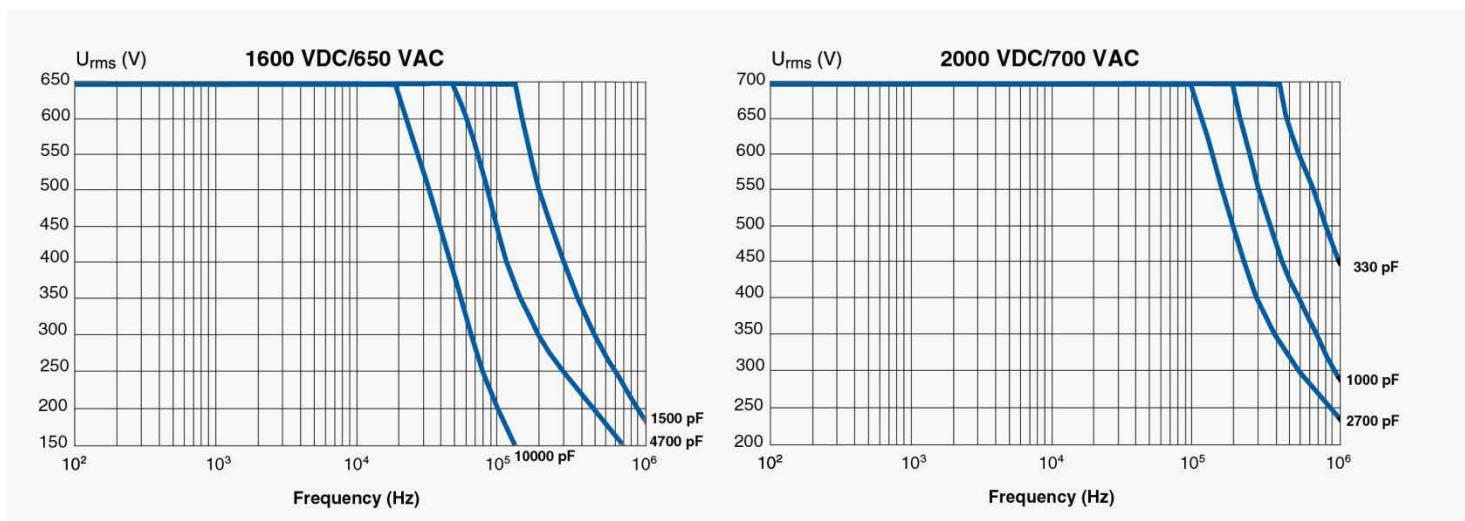

NOT FOR NEW DESIGN

Film Capacitors – General Purpose, Pulse and DC Transient Suppression

PHE448 Polypropylene Film/Foil, Radial



Environmental Test Data

Test	IEC Publication	Procedure	Requirements
Voltage Proof	60384-1 Clause 4.6	$1.6 \times V_R$ after 60 seconds	The capacitors must withstand the voltage without breakdowns or flashovers and without decreased insulation resistance below the value in each detail specification. No visible damage
	Clause 4.6 2.3	$2 \times V_R$ (minimum 400 VDC to case) after 60 seconds	As above
Vibration	60068-2-6 Test Fc	6 hours with 10 – 500 Hz and 0.75 mm amplitude or 98 m/s ² depending on frequency	No visible damage $\tan\delta \leq 1.2 \times$ stated value at 100 kHz $\Delta C/C \leq \pm 0.5\%$
Bump	60068-2-29 Test Eb	4,000 bumps with 390 m/s ² mounted on PCB	$\Delta C/C \leq \pm 0.5\%$ $\tan\delta \leq 1.2 \times$ stated value at 100 kHz Insulation resistance: $\geq 100,000 \text{ M}\Omega$ for $C_R \leq 0.33 \mu\text{F}$ $\geq 30,000 \text{ M}\Omega \cdot \mu\text{F}$ for $C_R > 0.33 \mu\text{F}$
Resistance to Soldering Heat	60068-2-20 Method 1A	Solder bath at $+260^\circ\text{C} \pm 5^\circ\text{C}$ with screening	Immersion of the terminations into the solder bath shall be completed in a time not exceeding 1 second and the terminations shall remain immersed to the specified depth for 10 + 1 second and then be withdrawn. $\Delta C/C \leq \pm 1.0\%$ $\tan\delta$ increase < 0.001 No visible damage
Climatic Sequence	60384-1 Paragraph 4:21	60068-2.2 dry heat 16 hours 60068-2-34 damp heat, one cycle 60068-2-1 Test Aa 2 hours	Insulation resistance: $\geq 100,000 \text{ M}\Omega$ for $C_R \leq 0.33 \mu\text{F}$ $\geq 30,000 \text{ M}\Omega \cdot \mu\text{F}$ for $C_R > 0.33 \mu\text{F}$ $\Delta C/C \leq \pm 0.5\%$ $\tan\delta \leq 1.2 \times$ stated value at 100 kHz
Damp Heat Steady State	60068-2-3 Test Ca	$+40^\circ\text{C}$ and 90 – 95% RH	56 days no visible damage Insulation resistance: $\geq 50,000 \text{ M}\Omega$ for $C_R \leq 0.33 \mu\text{F}$ $\geq 15,000 \text{ M}\Omega \cdot \mu\text{F}$ for $C_R > 0.33 \mu\text{F}$ $\Delta C/C \leq \pm 1\%$ $\tan\delta \leq 1.2 \times$ stated value at 100 kHz
Endurance, AC		1,000 hours at $+85^\circ\text{C}$ and $1.25 \times V_R$ AC	No visible damage $\Delta C/C \leq \pm 3\%$ $\tan\delta \leq 1.5 \times$ stated value at 100 kHz Insulation resistance: $\geq 100,000 \text{ M}\Omega$ for $C_R \leq 0.33 \mu\text{F}$ $\geq 30,000 \text{ M}\Omega \cdot \mu\text{F}$ for $C_R > 0.33 \mu\text{F}$
Charge and Discharge	60384-17 Paragraph 4.13	10,000 pulses and with (2 x) dV/dt according to detail specification	$\tan\delta$ (100 kHz) $\leq 2 \times$ stated value (100 kHz) $\Delta C/C \leq \pm 0.5\%$ Insulation resistance: $\geq 50,000 \text{ M}\Omega$ for $C_R \leq 0.33 \mu\text{F}$ $\geq 15,000 \text{ M}\Omega \cdot \mu\text{F}$ for $C_R > 0.33 \mu\text{F}$

NOT FOR NEW DESIGN

Film Capacitors – General Purpose, Pulse and DC Transient Suppression

PHE448 Polypropylene Film/Foil, Radial



Environmental Compliance

All KEMET pulse capacitors are RoHS Compliant.



Table 1 – Ratings & Part Number Reference

VDC	VAC	Cap Value (µF)	Dimensions in mm			Lead Spacing (S)	dV/dt (V/µs)	Size Code (New/Legacy)	R _{thha} °C/W 85°C 0.2m/s	KEMET Part Number	Legacy Part Number
			T	H	L						
1600	650	0.0015	5.5	10.5	18.0	15	15000	BD/B04	87	F448BD152J1K6(1)	PHE448RB4150J(1)
1600	650	0.0018	5.5	10.5	18.0	15	15000	BD/B04	86	F448BD182J1K6(1)	PHE448RB4180J(1)
1600	650	0.0022	5.5	10.5	18.0	15	15000	BD/B04	84	F448BD222J1K6(1)	PHE448RB4220J(1)
1600	650	0.0027	6.5	12.5	18.0	15	15000	BJ/B10	82	F448BJ272J1K6(1)	PHE448RB4270J(1)
1600	650	0.0033	6.5	12.5	18.0	15	15000	BJ/B10	82	F448BJ332J1K6(1)	PHE448RB4330J(1)
1600	650	0.0039	6.5	12.5	18.0	15	15000	BJ/B10	82	F448BJ392J1K6(1)	PHE448RB4390J(1)
1600	650	0.0047	6.5	12.5	18.0	15	15000	BJ/B10	82	F448BJ472J1K6(1)	PHE448RB4470J(1)
1600	650	0.0056	7.5	14.5	18.0	15	15000	BL/B06	78	F448BL562J1K6(1)	PHE448RB4560J(1)
1600	650	0.0068	7.5	14.5	18.0	15	15000	BL/B06	78	F448BL682J1K6(1)	PHE448RB4680J(1)
1600	650	0.0082	8.5	16.0	18.0	15	15000	BQ/B11	70	F448BQ822J1K6(1)	PHE448RB4820J(1)
1600	650	0.01	8.5	16.0	18.0	15	15000	BQ/B11	70	F448BQ103J1K6(1)	PHE448RB5100J(1)
1600	650	0.012	9.5	17.5	18.0	15	15000	BV/B14	60	F448BV123J1K6(1)	PHE448RB5120J(1)
1600	650	0.015	9.5	17.5	18.0	15	15000	BV/B14	60	F448BV153J1K6(1)	PHE448RB5150J(1)
1600	650	0.018	11.0	19.0	18.0	15	15000	BY/B16	55	F448BY183J1K6(1)	PHE448RB5180J(1)
1600	650	0.022	11.0	19.0	18.0	15	15000	BY/B16	55	F448BY223K1K6(2)	PHE448RB5220K(2)
2000	700	0.0001	5.5	10.5	18.0	15	25000	BD/B04	87	F448BD101J2K0(1)	PHE448SB3100J(1)
2000	700	0.00012	5.5	10.5	18.0	15	25000	BD/B04	87	F448BD121J2K0(1)	PHE448SB3120J(1)
2000	700	0.00015	5.5	10.5	18.0	15	25000	BD/B04	87	F448BD151J2K0(1)	PHE448SB3150J(1)
2000	700	0.00018	5.5	10.5	18.0	15	25000	BD/B04	87	F448BD181J2K0(1)	PHE448SB3180J(1)
2000	700	0.00022	5.5	10.5	18.0	15	25000	BD/B04	87	F448BD221J2K0(1)	PHE448SB3220J(1)
2000	700	0.00027	5.5	10.5	18.0	15	25000	BD/B04	87	F448BD271J2K0(1)	PHE448SB3270J(1)
2000	700	0.00033	5.5	10.5	18.0	15	25000	BD/B04	86	F448BD331J2K0(1)	PHE448SB3330J(1)
2000	700	0.00039	5.5	10.5	18.0	15	25000	BD/B04	86	F448BD391J2K0(1)	PHE448SB3390J(1)
2000	700	0.00047	5.5	10.5	18.0	15	25000	BD/B04	86	F448BD471J2K0(1)	PHE448SB3470J(1)
2000	700	0.00056	5.5	10.5	18.0	15	25000	BD/B04	85	F448BD561J2K0(1)	PHE448SB3560J(1)
2000	700	0.00068	5.5	10.5	18.0	15	25000	BD/B04	85	F448BD681J2K0(1)	PHE448SB3680J(1)
2000	700	0.00082	5.5	10.5	18.0	15	25000	BD/B04	85	F448BD821J2K0(1)	PHE448SB3820J(1)
2000	700	0.001	5.5	10.5	18.0	15	25000	BD/B04	84	F448BD102J2K0(1)	PHE448SB4100J(1)
2000	700	0.0012	6.5	12.5	18.0	15	25000	BJ/B10	82	F448BJ122J2K0(1)	PHE448SB4120J(1)
2000	700	0.0015	6.5	12.5	18.0	15	25000	BJ/B10	82	F448BJ152J2K0(1)	PHE448SB4150J(1)
2000	700	0.0018	7.5	14.5	18.0	15	25000	BL/B06	78	F448BL182J2K0(1)	PHE448SB4180J(1)
2000	700	0.0022	8.5	16.0	18.0	15	25000	BQ/B11	70	F448BQ222J2K0(1)	PHE448SB4220J(1)
2000	700	0.0027	8.5	16.0	18.0	15	25000	BQ/B11	70	F448BQ272J2K0(1)	PHE448SB4270J(1)
2000	700	0.0033	9.5	17.5	18.0	15	25000	BV/B14	60	F448BV332J2K0(1)	PHE448SB4330J(1)
VDC	VAC	Cap Value (µF)	T (mm)	H (mm)	L (mm)	Lead Spacing (S)	dV/dt (V/µs)	Size Code (New/Legacy)	R _{thha} °C/W 85°C 0.2m/s	KEMET Part Number	Legacy Part Number

(1) Insert lead and packaging code. See Order Options Table for available options.

(2) K = ±10% (only available tolerance).

Soldering Process

The implementation of the RoHS directive has resulted in the selection of SnAgCu (SAC) alloys or SnCu alloys as primary solder. This has increased the liquidus temperature from that of 183°C for SnPb eutectic alloy to 217 – 221°C for the new alloys. As a result, the heat stress to the components, even in wave soldering, has increased considerably due to higher pre-heat and wave temperatures. Polypropylene capacitors are especially sensitive to heat (the melting point of polypropylene is 160 – 170°C). Wave soldering can be destructive, especially for mechanically small polypropylene capacitors (with lead spacing of 5 mm to 15 mm), and great care has to be taken during soldering. The recommended solder profiles from KEMET should be used. Please consult KEMET with any questions. In general, the wave soldering curve from IEC Publication 61760-1 Edition 2 serves as a solid guideline for successful soldering. Please see Figure 1.

Reflow soldering is not recommended for through-hole film capacitors. Exposing capacitors to a soldering profile in excess of the above the recommended limits may result to degradation or permanent damage to the capacitors.

Do not place the polypropylene capacitor through an adhesive curing oven to cure resin for surface mount components. Insert through-hole parts after the curing of surface mount parts. Consult KEMET to discuss the actual temperature profile in the oven, if through-hole components must pass through the adhesive curing process. A maximum two soldering cycles is recommended. Please allow time for the capacitor surface temperature to return to a normal temperature before the second soldering cycle.

Manual Soldering Recommendations

Following is the recommendation for manual soldering with a soldering iron.

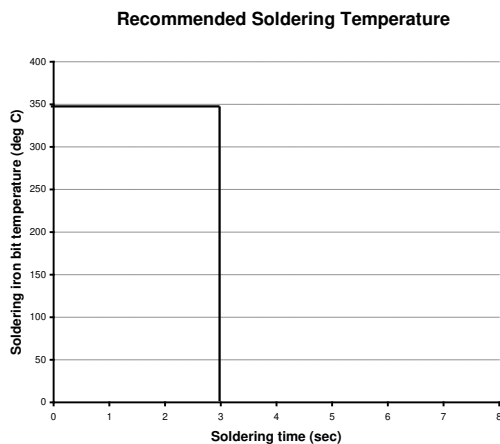

The soldering iron tip temperature should be set at 350°C (+10°C maximum) with the soldering duration not to exceed more than 3 seconds.

Wave Soldering Recommendations

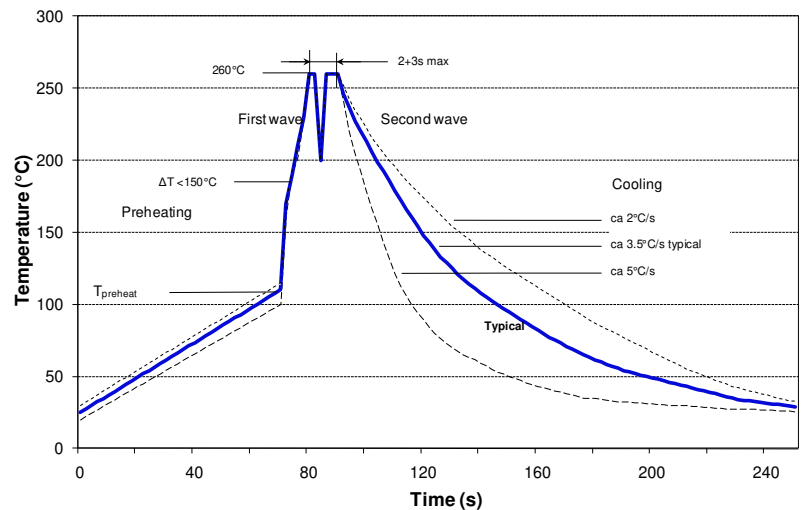

Soldering Process cont.

Wave Soldering Recommendations cont.

1. The table indicates the maximum set-up temperature of the soldering process
Figure 1

Dielectric Film Material	Maximum Preheat Temperature			Maximum Peak Soldering Temperature	
	Capacitor Pitch ≤ 10 mm	Capacitor Pitch = 15 mm	Capacitor Pitch > 15 mm	Capacitor Pitch ≤ 15 mm	Capacitor Pitch > 15 mm
Polyester	130°C	130°C	130°C	270°C	270°C
Polypropylene	100°C	110°C	130°C	260°C	270°C
Paper	130°C	130°C	140°C	270°C	270°C
Polyphenylene Sulphide	150°C	150°C	160°C	270°C	270°C

2. The maximum temperature measured inside the capacitor:

Set the temperature so that inside the element the maximum temperature is below the limit:

Dielectric Film Material	Maximum temperature measured inside the element
Polyester	160°C
Polypropylene	110°C
Paper	160°C
Polyphenylene Sulphide	160°C

Temperature monitored inside the capacitor.

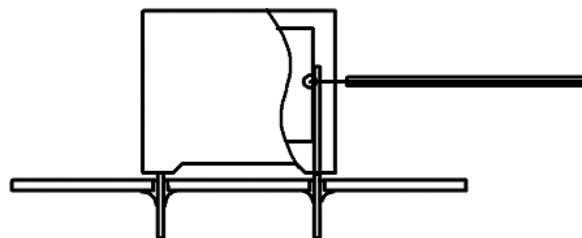

Selective Soldering Recommendations

Selective dip soldering is a variation of reflow soldering. In this method, the printed circuit board with through-hole components to be soldered is preheated and transported over the solder bath as in normal flow soldering without touching the solder. When the board is over the bath, it is stopped and pre-designed solder pots are lifted from the bath with molten solder only at the places of the selected components, and pressed against the lower surface of the board to solder the components.

The temperature profile for selective soldering is similar to the double wave flow soldering outlined in this document, **however, instead of two baths, there is only one bath with a time from 3 to 10 seconds.** In selective soldering, the risk of overheating is greater than in double wave flow soldering, and great care must be taken so that the parts are not overheated.

NOT FOR NEW DESIGN

Film Capacitors – General Purpose, Pulse and DC Transient Suppression

PHE448 Polypropylene Film/Foil, Radial

KEMET
a YAGEO company

Construction

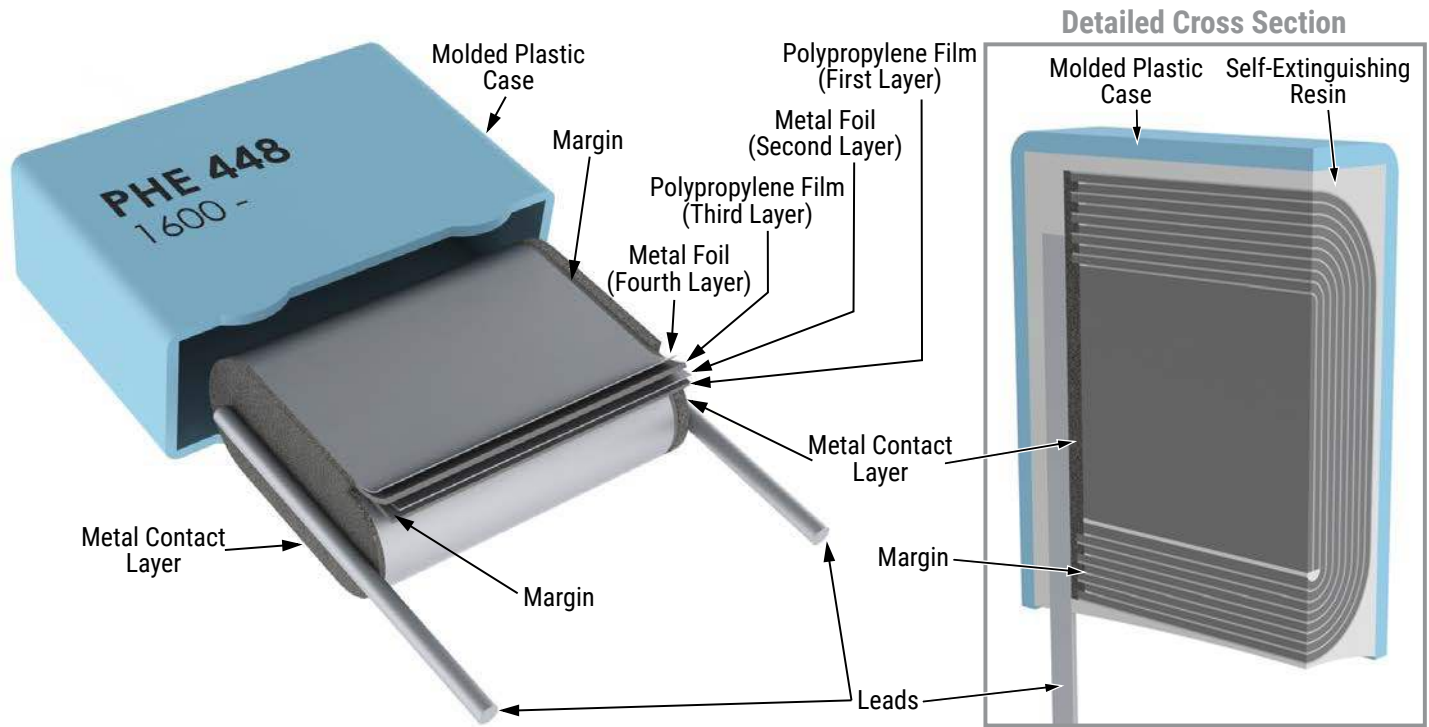

Winding Scheme

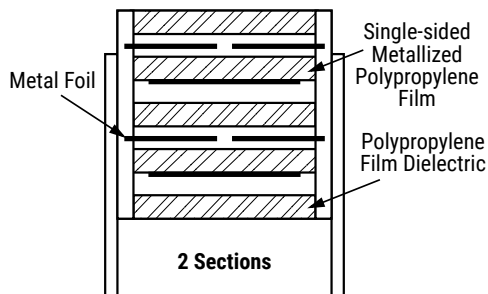

NOT FOR NEW DESIGN

Film Capacitors – General Purpose, Pulse and DC Transient Suppression

PHE448 Polypropylene Film/Foil, Radial

KEMET
a YAGEO company

Marking

Variant 1

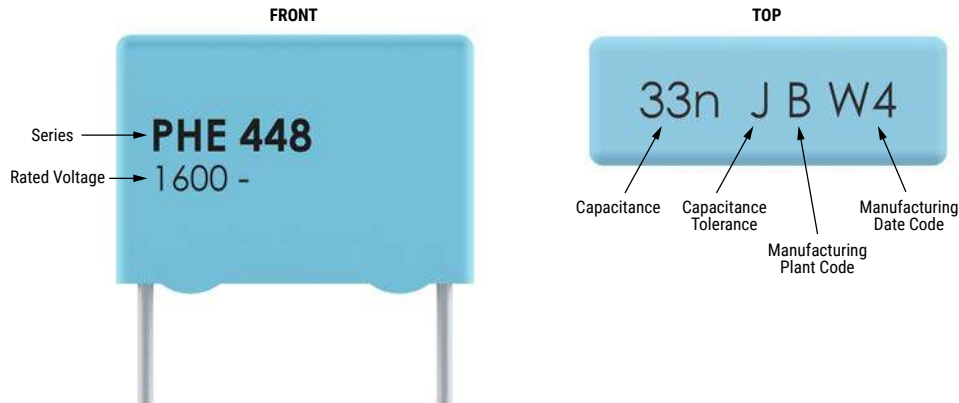

Variant 2

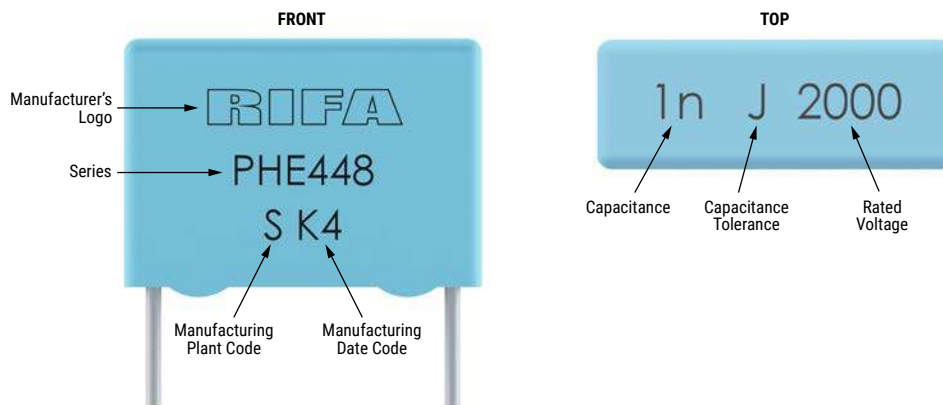

Packaging Quantities

KEMET Size Code	Legacy Size Code	Lead Spacing	Thickness (mm)	Height (mm)	Length (mm)	Bulk Short Leads	Bulk Long Leads	Standard Reel ø 360 mm	Large Reel ø 500 mm	Standard Reel Formed	Ammo Formed
BD	B04	15	5.5	10.5	18	1,000	800	600	1,200	550	570
BE	B05		5.5	12.5	18	1,000	800	600	1,200	550	570
BL	B06		7.5	14.5	18	800	400	400	800	350	378
BJ	B10		6.5	12.5	18	1,000	600	500	1,000	450	480
BQ	B11		8.5	16	18	600	400	400	800	350	324
BM	B12		8	15	18	600	400	400	800	350	351
BV	B14		9.5	17.5	18	500	300	350	700	250	297
BG	B15		6	12	18	1,000	800	500	1,000	450	520
BY	B16		11	19	18	450	250	300	600	250	252
BU	B17		13	12.5	18	400	300	250	500	200	216

NOT FOR NEW DESIGN

Film Capacitors – General Purpose, Pulse and DC Transient Suppression

PHE448 Polypropylene Film/Foil, Radial

KEMET
a YAGEO company

Lead Taping & Packaging (IEC 60286-2)

Lead Spacing 5 mm

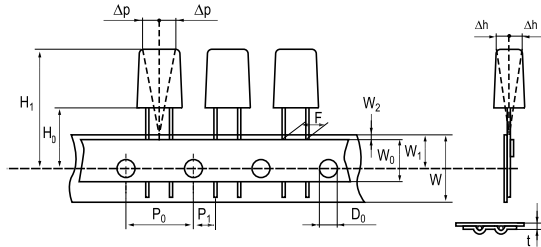

Lead Spacing 7.5 mm

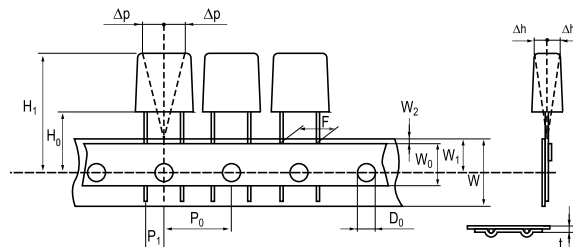

Lead Spacing 10 – 15mm

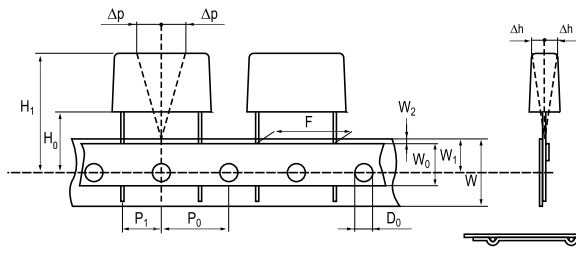

Lead Spacing 22.5 – 27.5 mm

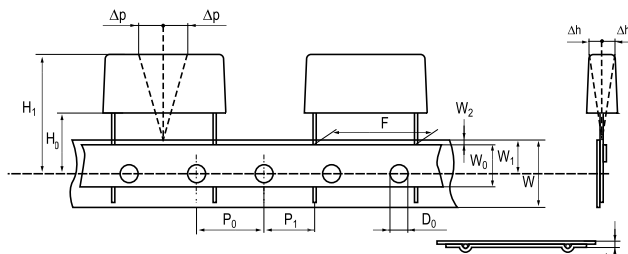

Formed Leads from 10 and 15 mm to 7.5 mm

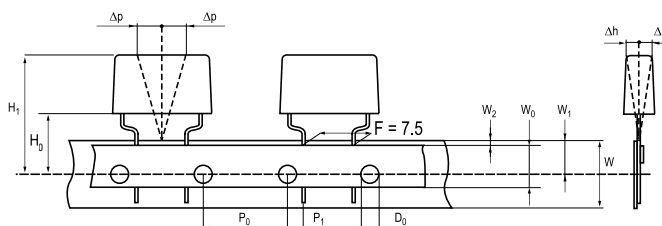

Taping Specification

Dimensions in mm										Standard IEC 60286-2
Lead Spacing	+0.6/-0.1	F	5	7.5	Formed 7.5	10	15	22.5	27.5	F
Carrier Tape Width	±0.5	W	18	18	18	18	18	18	18	18±1/-0.5
Hold-down Tape Width	Minimum	W ₀	5	5	5	5	5	5	5	
Position of Sprocket Hole	±0.5	W ₁	9	9	9	9	9	9	9	9+0.75/-0.5
Distance Between Tapes	Maximum	W ₂	3	3	3	3	3	3	3	3
Sprocket Hole Diameter	±0.2	D ₀	4	4	4	4	4	4	4	4
Feed Hole Lead Spacing	±0.3	P ₀ (1)	12.7	12.7	12.7 (4)	12.7	12.7	12.7	12.7	12.7
Distance Lead – Feed Hole	±0.7	P ₁	3.85	3.75	3.75	7.7	5.2	5.3	5.3	P1
Deviation Tape – Plane	Maximum	Δ p	1.3	1.3	1.3	1.3	1.3	1.3	1.3	1.3
Lateral Deviation	Maximum	Δ h	2	2	2	2	2	2	2	2
Total Thickness	±0.2	t	0.7	0.7	0.7	0.7	0.7	0.9 Maximum	0.9 Maximum	0.9 Maximum
Sprocket Hole/Cap Body	Nominal	H ₀ (2)	18.5±0.5	18.5±0.5	18.5±0.5	18.5±0.5	18.5±0.5	18.5±0.5	18.5±0.5	18.0±2/-0
Sprocket Hole/Top of Cap Body	Maximum	H ₁ (3)	32	31	43	43	43	58	58	58 Maximum

(1) Maximum cumulative feed hole error, 1 mm per 20 parts

(2) 16.5 mm available on request

(3) Depending on case size

(4) 15 mm available on request

NOT FOR NEW DESIGN

Film Capacitors – General Purpose, Pulse and DC Transient Suppression
PHE448 Polypropylene Film/Foil, Radial

KEMET
a YAGEO company

Lead Taping & Packaging (IEC 60286-2) cont.

Ammo Specifications

Series	Dimensions (mm)		
	H	W	T
R4x, R4x+R, R7x, RSB	360	340	59
F5A, F5B, F5D			
F6xx, F8xx			
PHExxx, PMExxx, PMRxxx, SMR & PFR	330	330	50

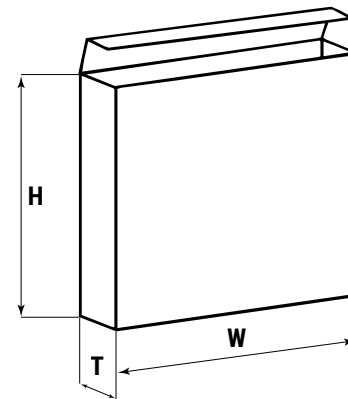

Reel Specifications

Series	Dimensions (mm)		
	D	H	W
R4x, R4x+R, R7x, RSB	355 500	30	55 (Max)
F5A, F5B, F5D		25	
F6xx, F8xx			
PHExxx, PMExxx, PMRxxx, SMR & PFR	360 500	30	46 (Max)

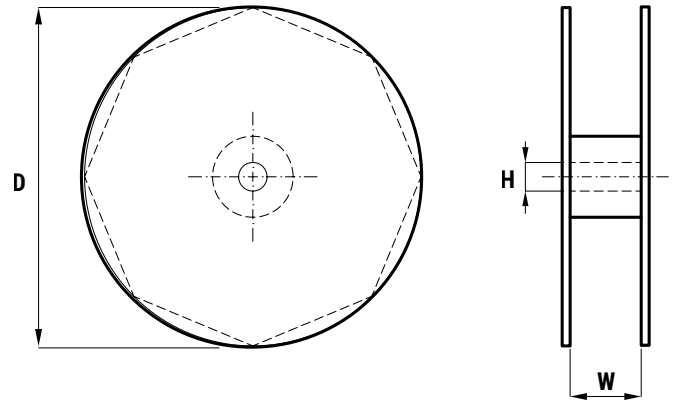

Manufacturing Date Code (IEC-60062)

Y = Year, Z = Month			
Year	Code	Month	Code
2010	A	January	1
2011	B	February	2
2012	C	March	3
2013	D	April	4
2014	E	May	5
2015	F	June	6
2016	H	July	7
2017	J	August	8
2018	K	September	9
2019	L	October	0
2020	M	November	N
2021	N	December	D
2022	P		
2023	R		
2024	S		
2025	T		
2026	U		
2027	V		
2028	W		
2029	X		
2030	A		

KEMET Electronics Corporation Sales Offices

For a complete list of our global sales offices, please visit www.kemet.com/sales.

Disclaimer

All product specifications, statements, information and data (collectively, the "Information") in this datasheet are subject to change. The customer is responsible for checking and verifying the extent to which the Information contained in this publication is applicable to an order at the time the order is placed. All Information given herein is believed to be accurate and reliable, but it is presented without guarantee, warranty, or responsibility of any kind, expressed or implied.

Statements of suitability for certain applications are based on KEMET Electronics Corporation's ("KEMET") knowledge of typical operating conditions for such applications, but are not intended to constitute – and KEMET specifically disclaims – any warranty concerning suitability for a specific customer application or use. The Information is intended for use only by customers who have the requisite experience and capability to determine the correct products for their application. Any technical advice inferred from this Information or otherwise provided by KEMET with reference to the use of KEMET's products is given gratis, and KEMET assumes no obligation or liability for the advice given or results obtained.

Although KEMET designs and manufactures its products to the most stringent quality and safety standards, given the current state of the art, isolated component failures may still occur. Accordingly, customer applications which require a high degree of reliability or safety should employ suitable designs or other safeguards (such as installation of protective circuitry or redundancies) in order to ensure that the failure of an electrical component does not result in a risk of personal injury or property damage.

Although all product-related warnings, cautions and notes must be observed, the customer should not assume that all safety measures are indicated or that other measures may not be required.